

# Safe Systems of Work and Technical Compliance for University Estates and Facilities

Training Prospectus | Version 23.1



# A Leading UK and International Training Provider



**50,000ft<sup>2</sup>**  
of Training Facilities



**30**  
Classrooms



**80+**  
Courses



**Knowledgeable**  
and Experienced Training Staff



Introduction from

## Gary Cooper

(MIHEEM Tech IOSH MSOE MIPlantE)  
**Managing Director**

We are an industry-leading UK and international provider of Safe Systems of Work, technical and compliance training.

We have an extensive portfolio of over 80 City & Guilds and BPEC accredited courses.

The Safe Systems of Work (SSoW) courses that we deliver are based upon the high risk disciplines within facilities management, Ministry of Defence (MOD) and healthcare environments.

It is industry standard that companies responsible for high risk engineering systems, adopt their own safety rules and procedures that their teams adhere to. These rules, and their respective requirements, are the foundation of our course portfolio.



Our courses are delivered by our highly experienced training team which allows us to develop our own in-house courses tailored for those within the relevant industries.

Training is in-line with the latest legislation and guidelines so that your team will receive up-to-date, factual tuition.

*G.Cooper*

# How we Deliver our Training

In-centre, at your site and online

We cover the whole of the UK from our purpose built, well established training centres in York, Slough and Livingston. Fitted with industry leading practical training facilities, this ensures that your team receive the best training possible.

Alternatively we are also able to provide training directly to your site or online through our remote training courses.

**City & Guilds**

APPROVED  
CENTRE

## Accommodation Required?

We can arrange **accommodation from £105<sup>+VAT</sup>** per person per night. Price includes dinner, bed and breakfast.



## Our Training Facilities

York



Slough



Tudor Court



Bedford Avenue



Buckingham Avenue

York:

Unit 5, 6, and 8 Opus Avenue  
Unit 4 Tudor Court

Slough:

468 Malton Avenue  
180 Bedford Avenue  
103 Buckingham Avenue

Livingston:

5 Deer Park Avenue



Deer Park Avenue

# Our Training Courses

## Safe Systems of Work and Technical Compliance for University Estates and Facilities

### Management of Safe Systems

Authorising Engineer	10
Facilities Management Contract Managers Technical Awareness	12

### Electrical Installations

18th Edition Wiring Regulations   City & Guilds 2382-22	16
Inspection, Testing and Certification of Electrical Installations   City & Guilds 2391-52	17
In-Service Inspection and Testing of Electrical Equipment (PAT Testing)   City & Guilds 2377-77	18
Fundamental Inspection and Electrical Testing   City & Guilds 2392-10	20
Design and Verification of Electrical Installations   City & Guilds 2396	21
Electric Vehicle Charging Equipment Installation   City & Guilds 2919-01	22
18th Edition Wiring Regulations Amendment 2 - Update	23

### High Voltage

Authorised Person High Voltage - Operation and Safety	32
SAP High Voltage - Commercial and Industrial Sectors	33
High Voltage Maintenance	34
High Voltage Awareness	35
High Voltage Technical	36
Substation Entry Awareness	37

### Low Voltage

Authorised Person Electrical Low Voltage	40
Skilled/Competent Person Electrical Low Voltage	41
Standby Systems	43



## Legionella Control and Management

Legionella Management for Water Systems	48
Legionella Awareness	49
Legionella and Water Hygiene Control Within Hot and Cold Water Systems	50
Risk Assessment for Legionella and Water Hygiene Control in Water Systems	51
Disinfection of Hot and Cold Water Systems	52
Control of Legionella Within Evaporative Cooling Systems	53
Legionella Control Refresher and Update	54
Legionella Awareness Within Evaporative Cooling Systems	55
Written Scheme of Control - Implementation of the Monitoring Requirements for Hot and Cold Water Systems	56
Legionella Control and Management of Hot and Cold Water Services and Evaporative Cooling Systems	57
Introduction to The Risk of Pseudomonas aeruginosa and Other Waterborne Pathogens	58
Swimming and Hydrotherapy Pool Operation and Management	59
Closed Water Systems Awareness Course	60
Servicing and Testing Requirements of Thermostatic Mixing Valves (TMV)	61

## Water Hygiene

Unvented Hot Water Storage	64
Water Regulations	65





## Medical Gas Pipeline Systems HTM 02-01

Authorised Person Medical Gas Pipeline Systems HTM 02-01	72
Authorised Person Medical Gas Pipeline Systems Refresher HTM 02-01	73
Competent Person Medical Gas Pipeline Systems HTM 02-01	74
Competent Person Medical Gas Pipeline Systems Refresher HTM 02-01	75
Dental Compressed Air and Vacuum Systems for use in Healthcare	76

## Mechanical and Electrical Conversion

Electrical to Mechanical Conversion	80
Mechanical to Electrical Conversion	81

## Confined Spaces and Working At Height

Authorised Person Confined Spaces (Commercial)	84
Competent Person Confined Spaces	85
Authorised Person Confined Spaces Refresher	86
Competent Person Confined Spaces Refresher	87
Authorised Person Working At Height (Commercial)	89

## Mechanical and Pressure Systems

Authorised Person Mechanical and Pressure Systems	92
Skilled Person Mechanical and Pressure Systems	93

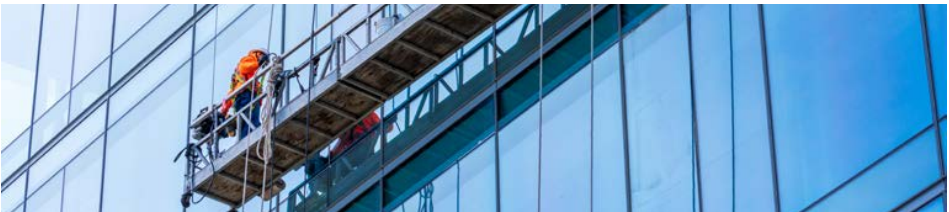



## Fire Safety

Fire Safety Responsible Person Introduction	100
Fire Safety Technical Awareness	101
Fire Door Survey and Inspection	102
Fire and Smoke Damper Survey and Inspection	103
Fire Stopping Survey and Inspection	104
Escape Lighting	105
Fire Alarms and Detection Systems - Commercial	107

## F-Gas Handling

F-Gas (Category 1)   City & Guilds 2079-11	110
F-Gas (Category 2)   City & Guilds 2079-12	111
F-Gas (Category 3)   City & Guilds 2079-13	112
F-Gas (Category 4)   City & Guilds 2079-14	113
Hydrocarbon Qualification   City & Guilds 6187-21	114
F-Gas Compliance	116
Introduction to Air Conditioning	117



We have a selection of training courses available at our new Livingston Centre.

[View Course Listing >](#)



ALSTOM

BIENVOENIDOS

ATENCIÓN AL CLIENTE





# Management of Safe Systems



Course Name	Code	Length	Price Exc. VAT
Authorising Engineer	AUENG	2 Day	£625
Facilities Management Contract Managers Technical Awareness	FMTA	2 Day	£525

Training available in York, Slough, Livingston and On-site



★★★★★

"Another Fantastic Course"

"Excellent course - first class instructors - superb facilities"

Jason - Beattie Flanigan

City & Guilds Accredited  
Authorising Engineer

## Authorising Engineer

📍 York, Slough, Livingston and On-site | 2 Day | £625

### Course Overview:

This course will provide you with the background knowledge required to carry out Authorising Engineer (AE) duties in support of statutory health and safety compliance. Our course can also be used to help you demonstrate the competency requirements of mandatory standards (MOD's JSP 375 Volume 3), guidance documents (Healthcare Technical Memoranda) or company rules.

Please note we have the ability to offer this course on-site at your premises.

### Who Is This Course For:

This course has been designed for experienced engineering staff responsible for the implementation, administration, monitoring and management of Safe Systems of Work, and who are looking to be appointed as an Authorising Engineer. The course will cover the key roles of an Authorising Engineer such as the appointment of operational staff - who will implement and work with the defined Safe Systems of Work.

### Key Learning Areas Covered In This Course:

- Understand the management of Safe Systems of Work
- Compliance and the role of the Authorising Engineer
- Authorised person selection, training and appointment
- Safety documentation - setting and maintaining standards
- Auditing and monitoring
- Incident investigation
- Maintaining competence
- Completion of log books and associated documentation



### The Role Of An Authorising Engineer:

The Authorising Engineer acts as an independent adviser to an organisation.

The AE should be appointed by the organisation to provide services in accordance with the organisation's relevant Safe Systems of Work, as well as HSE, Health Technical Memoranda (HTM) or Joint Service Publication (JSP) guidance.

The AE's role is to act as a technical assessor who makes recommendations for the appointment of Authorised Persons (AP's). Once AP's are appointed, the AE will continue to monitor the performance of the service and provide annual audits. With regards to audit in particular, the AE should remain independent of the operational structure of the organisation.



#### "A Great Service"

"A great service delivered by a very knowledgeable team in a good location with outstanding facilities. Well done PPL."

Delegate Review - MOD

City & Guilds Accredited  
Authorising Engineer



## Facilities Management Contract Managers Technical Awareness

FMTA

📍 York, Slough, Livingston and On-site | 2 Day | **£525**

### Course Overview:

This in-depth City & Guilds accredited training course has been designed to provide an overview and understanding of the statutory and regulatory inspections/maintenance tasks required within a Facilities Management contract, as detailed within CIBSE guidance. This will also cover management responsibilities, in line with Health and Safety legislation.

### Who Is This Course For:

This course is for Contract Managers, within the Facilities Management environment, who require a better understanding of their engineering responsibilities, when managing contracts. This will also cover the requirement for statutory and regulatory inspections/maintenance.

The course covers a wide range of core areas including the following requirements; building services systems, fire safety, electrical systems safety, energy and environment, mechanical systems safety and ventilation systems.



**"Very well taught course -  
Would definitely recommend"**

"In depth training provided by a very knowledgeable trainer. I would definitely re-use PPL for future training courses and would recommend to others considering using PPL as a training provider."

Delegate Review - NHS

City & Guilds Accredited  
Facilities Management  
Contract Managers  
Technical Awareness



### Key Learning Areas Covered In This Course:

- General H&S and the responsibility of the Contract Manager
- HSAW Act 1974 & surrounding legislation, including Contract Manager responsibilities
- Building services systems
- The requirements of the Asbestos at Work Regs, Noise at Work Regs, CoSHH, Water Systems and generic hazards in the workplace
- Fire safety requirements
- Fire Safety Order 2005 and the requirements of the Fire Risk Assessment
- Energy and environmental requirements
- Understand the variety of requirements with respects to energy and environment in a typical contract - i.e. water use, waste management, WEEE etc
- Electrical systems safety requirements
- The basic requirements of the Electricity at Work Regulations 1989
- NICEIC considerations - minor works certs, contractor control, quality supervision
- Inspection and testing requirements, PAT requirements, emergency lighting/lightning conductors
- Mechanical systems safety requirements
- The basic requirements of PSSR, PUWER, PER etc | Types of pressure systems
- Written Scheme of Examination and inspection regimes | gas safety (U&I) regs | vent systems
- Lifts, escalators and hoists
- The basic requirements of LOLER, PUWER Etc | servicing and inspection regimes for all equipment



# Electrical Installations



Course Name	Code	Length	Price Exc. VAT
18th Edition Wiring Regulations   City & Guilds 2382-22	2382-22	3 Day	£500
Inspection, Testing and Certification of Electrical Installations   City & Guilds 2391-52	2391-52	7 Day	£1,155
In-Service Inspection and Testing of Electrical Equipment (PAT Testing)   City & Guilds 2377-77	2377A2	2 Day	£475
Fundamental Inspection and Electrical Testing   City & Guilds 2392-10	2392	4 Day	£750
Design and Verification of Electrical Installations   City & Guilds 2396	2396	5 Day	£875
Electric Vehicle Charging Equipment Installation   City & Guilds 2919-01	2919	2 Day	£455
18th Edition Wiring Regulations Amendment 2 - Update	2382-UP	1 Day	£320

Training available in York, Slough and Livingston



# Requirements for Electrical Installations

IET Wiring Regulations  
Eighteenth Edition

BS 7671:2018  
Incorporating  
Corrigendum 2018  
Amendment 1:2020  
Amendment 2:2022

## 18th Edition Wiring Regulations | City & Guilds 2382-22

📍 York, Slough and Livingston | 3 Day | **£500**

### Course Overview:

This City & Guilds course will enable you to demonstrate a detailed knowledge of the IET Wiring Regulations 18th Edition known as BS7671:2018 (Amendment 2 2022) Requirements for Electrical Installations.

This course is also available as an on-site event. Please contact our account management team for more information.

### Who Is This Course For:

This course is aimed at those involved with the design, installation or testing of electrical installations in accordance with the 18th Edition of the IET Wiring Regulations.

### Key Learning Areas Covered In This Course:

- Scope, object and fundamental principles of BS7671:2018
- Electrical definitions
- Assessment of general characteristics
- Requirements of protection for electrical safety
- Selection and erection of equipment
- Electrical inspection and testing
- Special installations or locations
- Use of the information within BS7671:2018 appendices
- Energy efficiency
- Prosumer low-voltage electrical installations
- Protection against fire - installation of arc fault detection devices (AFDDs)
- Protection against transient over voltage
- Assessment includes a two hour online multiple-choice exam



# Inspection, Testing and Certification of Electrical Installations | City & Guilds 2391-52

📍 York and Slough | 7 Day | £1,155

2391-52

## Course Overview:

This City & Guilds course replaces the previous City & Guilds 2394, 2395 and earlier 2391-10 courses. This seven day course combines both the new 2391-50 and 2391-51 into one course saving you five days over doing both courses separately. This course will enable you to demonstrate the knowledge and skills required to carry out inspection and testing of electrical installations in accordance with the requirements of Part 6 of BS7671 and the Institution of Engineering Technology's Guidance Note 3 (GN3).

Prior to attending this course you should have completed an appropriate qualification in electrical installation and possess a good working knowledge of the industry.

**See our website for a full list of prerequisites for this course.**

## Who Is This Course For:

The course is aimed at practising electricians who wish to obtain a recognised qualification in inspection and testing, including both periodic inspection and initial verification. Delegates should already hold an 18th Edition Certificate and be familiar with the IET's GN3. PPL also strongly recommend having suitable practical experience of testing prior to attending this course.

## Key Learning Areas Covered In This Course:

- Understand the reasons for inspecting and testing electrical installations
- Safe isolation of electrical circuits and installations
- Requirements for completing initial inspection and verification
- Selection and use of suitable test equipment
- Requirements for testing circuits prior to energisation
- Requirements for testing circuits after energisation
- Understanding and evaluation of test results
- Completion of appropriate test certificates and associated documentation
- Safety of systems and equipment prior to completion of inspection and testing
- Classification categories for different types of fault

## In-Service Inspection and Testing of Electrical Equipment (PAT Testing) | City & Guilds 2377-77

📍 York, Slough and Livingston | 2 Day | £475

### Course Overview:

This two day City & Guilds' course has been designed for those with electrical experience, who want to cover the new Institution of Engineering and Technology In-service inspection and testing of electrical equipment 5th edition.

A notable change from the old City & Guilds Portable Appliance Testing course, is the focus on all electrical equipment, both portable and installed - moving away from the traditional "Portable" terminology.

The largest change to the 5th edition is its move towards a risk assessment based inspection, with all inspection and testing of equipment to be carried out following an implemented electrical risk assessment. Throughout the course you will learn how to structure, implement and document this risk assessment and how to carry out the practical aspects of testing.

Upon completion of this City & Guilds electrical technical course, you will gain the working knowledge to ensure the safety of electrical equipment in accordance with the newest codes of practices. In addition to the essential knowledge you will gain - this City & Guilds accredited certificate is formal recognition of your skills and experience, which can improve your career prospects and provide new opportunities to progress into other electrical roles.

**To sit this course you should be a holder of the 18th Edition wiring regulations BS7671:2018, and - At least one of the following :-**

- An ECS card,
- JIB electrician grade card
- Have successfully completed an NVQ based electrotechnical apprenticeship or technical certificate to level 3
- Be familiar with the electrical systems and hazards electricity can bring.



### Who Is This Course For:

This course has been designed for those with an established electrical background and a good understanding of electrical testing, who want to or currently have the responsibility of in-services inspection and testing of electrical equipment. It is important to remember that if you are the duty holder of inspection and testing, it is essential that you are up to date with the latest approved codes of practice to ensure the safety of the site.

This course is intended for those with an established electrical background and a good understanding of testing. The course covers both management and the practical aspects of testing and is ideal for those looking to offer electrical equipment testing/ portable appliance testing as a service. It is recommended that you have successfully completed an NVQ based electrotechnical apprenticeship or technical certificate to Level 3.

### Key Learning Areas Covered In This Course:

- Equipment construction
- Inspection
- Combined inspection and testing
- Recording and use of instruments
- Visual inspection
- Class one and class two tests
- Continuity tests
- Functionality tests
- Insulation tests
- Risk Assessment

## Fundamental Inspection and Electrical Testing | City & Guilds 2392-10

📍 York and Slough | 4 Day | £750

### Course Overview:

This City & Guilds course will provide you with the skills, knowledge and confidence to inspect and test fundamental installations and to conduct the initial verification.

### Who Is This Course For:

This is aimed at practising electricians who have not carried out inspection and testing since qualifying, or who require some updated training. It is also suitable for those with limited experience of inspection and testing of electrical installations who wish to develop their skills in this area.

### Key Learning Areas Covered In This Course:

- Understand safe isolation of electrical circuits and installations
- Requirements for inspecting, testing and recording of installations
- Requirements for completing an initial verification
- Requirements for testing before circuits are energised
- Testing of energised installations
- Interpretation of test results
- Requirements for completion of electrical installation certificate
- Assessment incorporates an online exam and a practical assessment



A close-up photograph of a person's hand holding a white and green electric vehicle charging cable. The background is blurred, showing what appears to be a charging station.

## Electric Vehicle Charging Equipment Installation | City & Guilds 2919-01

2919

 York and Slough | 2 Day | **£455**

### Course Overview:

This City & Guilds training course will allow you to take advantage of the surge of interest in the domestic and commercial electric vehicle market. It will provide you with the skills and knowledge required to install dwelling and on street charging points.

### Who Is This Course For:

This is aimed at qualified electricians who wish to include the installation of electrical vehicle charging equipment as part of their work. Delegates should have already completed an 18th Edition Course, and be familiar with the IET Code of Practice. We also strongly recommend having practical experience of inspection and testing prior to attending this course.

### Key Learning Areas Covered In This Course:

- Introduction, BS7671 section 722 and the IET Code of Practice
- Modes of charging, Electrical Vehicle Supply Equipment (EVSE) and DNO restrictions
- Installation practices, risk assessment, earthing, protection, labelling and practical exercises
- On street, commercial and industrial situations
- Inspection and commissioning
- Certification and notification to DNO

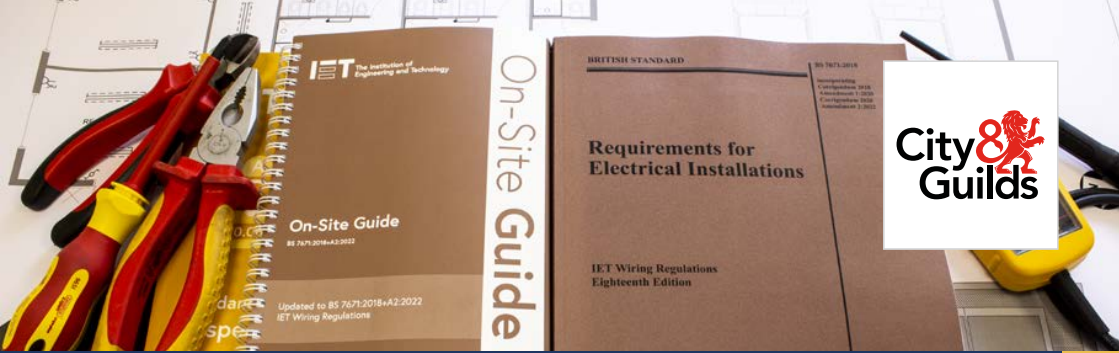

# 18th Edition Wiring Regulations Amendment 2 – Update

📍 York and Slough | 1 Day | £320

2382-UP

## Course Overview:

This course will enable you to demonstrate a detailed knowledge of the updates to the IET Wiring Regulations 18th Edition known as BS7671:2018 (Amendment 2 2022) Requirements for Electrical Installations, since Amendment 1 2020. This course is also available as an on-site event. Please contact our account management team for more information.

**At the end of this course, you will be assessed to the City & Guilds 2382-22 question bank.**

## Who Is This Course For:

This course is aimed at those involved with the design, installation or testing of electrical installations in accordance with the 18th Edition of the IET Wiring Regulations. If you wish to attend this course, you must be able to demonstrate the necessary skills and knowledge required by BS7671:2018 (Amendment 1 2020), and hold a relevant qualification (2382-18 Qualification).

## Key Learning Areas Covered In This Course:

- Scope, object and fundamental principles of BS7671:2018
- Electrical definitions and assessment of general characteristics
- Requirements of protection for electrical safety
- Selection and erection of equipment
- Electrical inspection and testing | Special installations or locations
- Use of the information within BS7671:2018 appendices
- Energy efficiency
- Prosumer low-voltage electrical installations
- Protection against fire – installation of arc fault detection devices (AFDDs)
- Protection against transient over voltage
- Assessment includes a two hour online multiple-choice exam

TO LOCAL TRANSFORMER

on

on

RING TO ISS

switch 1

switch 2

circuit earth

**MERLIN GERIN**  
**Administrateur - RNDC**

Adresse :  
 Téléphone :  
 Fax :  
 Courriel :  
 Site Web :  
 Date de mise à jour :  
 Version :

Ratings			
Rating	Standard	Value	Unit
Rated current	IEC 60898-1	16	A
Rated short-circuit capacity	IEC 60898-1	1000	VA
Rated breaking capacity	IEC 60898-1	1000	VA
Rated making capacity	IEC 60898-1	1000	VA
Rated switching capacity	IEC 60898-1	1000	VA
Rated energy capacity	IEC 60898-1	1000	VA
Rated power capacity	IEC 60898-1	1000	VA
Rated voltage	IEC 60898-1	230	V
Rated frequency	IEC 60898-1	50	Hz
Rated ambient temperature	IEC 60898-1	30	°C
Rated altitude	IEC 60898-1	2000	m
Rated pollution degree	IEC 60898-1	3	
Rated overvoltage category	IEC 60898-1	III	
Rated impulse withstand capacity	IEC 60898-1	2.5	kV
Rated surge withstand capacity	IEC 60898-1	2.5	kV
Rated short-circuit current	IEC 60898-1	1000	A
Rated short-circuit energy	IEC 60898-1	1000	VA
Rated short-circuit power	IEC 60898-1	1000	VA
Rated short-circuit current (100ms)	IEC 60898-1	1000	A
Rated short-circuit energy (100ms)	IEC 60898-1	1000	VA
Rated short-circuit power (100ms)	IEC 60898-1	1000	VA
Rated short-circuit current (1s)	IEC 60898-1	1000	A
Rated short-circuit energy (1s)	IEC 60898-1	1000	VA
Rated short-circuit power (1s)	IEC 60898-1	1000	VA



# High Voltage



Course Name	Code	Length	Price Exc. VAT
Authorised Person High Voltage - Operation and Safety	APHV1	5 Day	£1,385
SAP High Voltage - Commercial and Industrial Sectors	APHV4	5 Day	£1,385
High Voltage Maintenance	HVM	5 Day	£1,385
High Voltage Awareness	HVASM	2 Day	£525
High Voltage Technical	HVTA	3 Day	£895
Substation Entry Awareness	SUBE	1 Day	£295

Training available in York, Slough, Livingston and On-site



★★★★★

**"Well paced and informative."**

"Excellent practical facilities, easy to find and comfortable venue."

David - University of Winchester

City & Guilds Accredited  
High Voltage Awareness

# HIGH VOLTAGE TRAINING GUIDE

## Authorised Person High Voltage Courses

Prospective Role	Typical Duties	Suggested Course(s)
Authorised Person	Responsible for the control, operation and/or maintenance of installed HV systems within all sectors. Appointed or about to be appointed as an Authorised Person.	APHV1 (page 32)
Senior Authorised Person	Responsible for control, operation and/or maintenance of installed HV systems. Appointed as Senior Authorised Person.	APHV1 (page 32) +/-or APHV4 (page 33)
Authorised Person (Healthcare)	Responsible for the control, operation and/or maintenance of installed HV systems. Appointed as Authorised Person in the healthcare sector.	APHV1 (page 22)

## Other High Voltage Courses

Role	Typical Duties	Optional Course(s)
Site Manager, Prospective AP, Low Voltage AP, Project Manager with an increased awareness	Responsible for the overall operation of a site or facility containing HV switchgear and the associated Health & Safety procedures for HV staff.	HVASM (page 35)
High Voltage AP, CP/SKP with an increased awareness and knowledge	Responsible for the safe operation and/or maintenance of HV switchgear.	HVM (page 35)
High voltage engineer with an increased knowledge	Responsible for the control, operation and/or maintenance of installed HV systems within any sector, which may include AP's, CP's, Skilled Persons or Operational Engineers.	HVTA (page 36)

# LOW VOLTAGE TRAINING GUIDE

Authorised/Competent Person Low Voltage Courses		
Prospective Role	Typical Duties	Suitable Course(s)
Authorised Person	Responsible for the practical implementation of the LV safety procedures within the commercial sector and/or the DIO.	APLV (page 40)
Skilled Person	Responsible for the safe operation and/or maintenance of LV systems within the commercial sector and/or the DIO.	CPLV (page 41)
Authorised Person (Healthcare)	Responsible for the practical implementation of the LV safety procedures as described in HTM 06-02.	APLVH and/or APLVR (See other literature)
Competent Person (Healthcare)	Responsible for the safe operation and/or maintenance of LV systems within healthcare environments.	CPLVH (See other literature)



# PPL HIGH VOLTAGE RING YORK

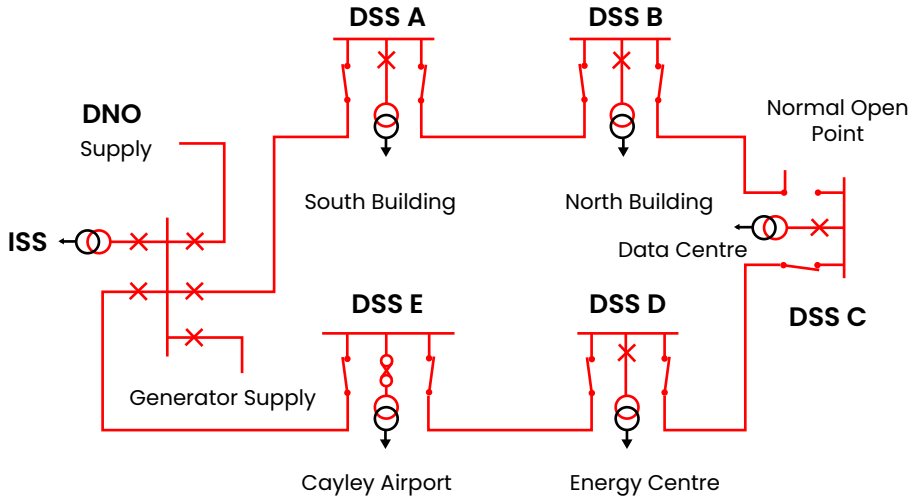

**ISS**  
NEI Reyrolle YMV2 VCB's



**DSS A**  
Yorkshire Switchgear  
Ringmaster SF6



**DSS B**  
GEC Alstom Saturn SF6



**DSS C**  
Lucy Sabre VRN2a SF6



**DSS D**  
Merlin Gerin  
Ringmaster SF6



**DSS E**  
Lucy FRMU  
MK1 Oil



**DSS G**  
Merlin Gerin  
Genie



**Live Phasing**  
Demonstration Rig  
2 x Reyrolle LMT23 OCB

# PPL NORTH HIGH VOLTAGE RING YORK

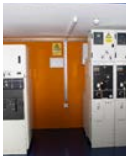
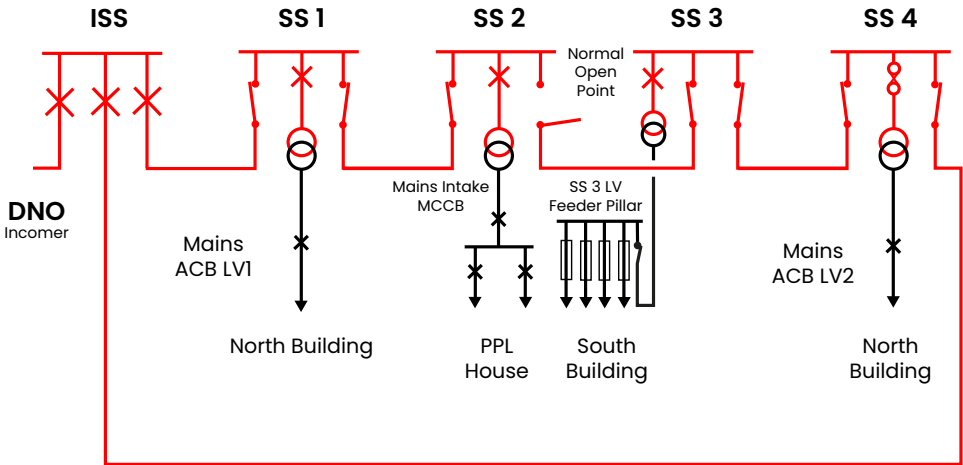

**ISS**  
Merlin Gerin  
Genie EVO, 2  
x Merlin Gerin  
Genie CB6  
Circuit Breaker



**SS 1**  
Schneider  
RN2C SF6 RMU



**SS 2**  
Lucy Sabre  
VRN2a SF6



**SS 3**  
2 x Merlin Gerin  
SE6 SF6  
Switches & Circuit  
Breaker



**SS 4**  
Lucy FRMU MK2a  
Oil Filled  
RMU



**Air Circuit  
Breaker**  
ABB SACE Emax 2



**Transformer**  
Parson Peebles  
Transformer



**Panel Board**  
Merlin Gerin  
MCCB



**LV Feeder Pillar**  
Merlin Gerin  
1600A LV  
Feeder Pillar



Merlin Gerin  
Masterpact

# PPL WINDSOR NORTH RING

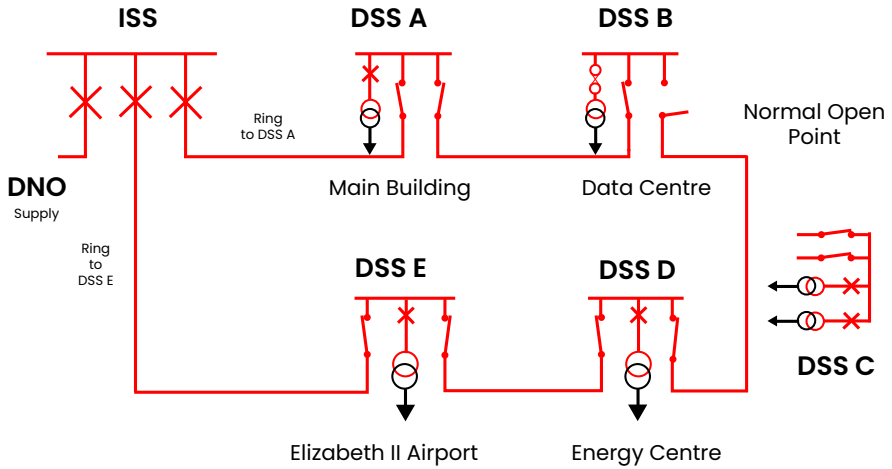

**ISS**  
GEC Alstom HWXA VCB's



**DSS A**  
Merlin Gerin Ringmaster  
CE2 200A SF6 CB SE6 630A SF6  
Switches



**DSS B**  
Long & Crawford T4GF3  
Oil RMU



**DSS C**  
Eaton XIRIA



**DSS D**  
Hawker Siddeley Brush  
Falcon SF6 RMU



**DSS E**  
Merlin Gerin Ringmaster  
RN2C SF6 RMU



**DSS G**  
Packaged Substation  
Merlin Gerin SE6 630A Switch +  
Transformer Earth Switch



**Stand Alone**  
Genie Evo

# PPL WINDSOR NORTH RING NO. 2

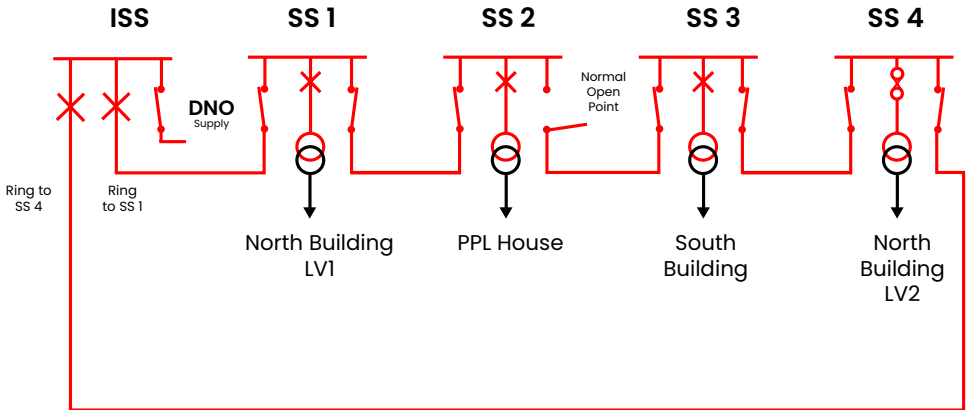

**ISS**  
Reyrolle LMT 23T OCB's  
Reyrolle oil switch  
(incomer)



**SS 1**  
Merlin Gerin Ringmaster  
RN2c SF6 RMU



**SS 2**  
Lucy Sabre  
VRN2a SF6 RMU



**SS 3**  
Alstom RT  
'Saturn' SF6  
RMU



**SS 4**  
Lucy Mk1a FRMU OIL RMU



## Authorised Person High Voltage – Operation and Safety

📍 York, Slough and On-site | 5 Day | **£1,385**

### Course Overview:

This City & Guilds Accredited course will enable you to gain the knowledge required to carry out Authorised Person duties and responsibilities in order to achieve compliance with the requirements of the Electricity at Work Regulations 1989 and implement mandatory standards or company safety rules.

Please note we have the ability to offer this course on-site at your premises and on a bespoke basis.

### Who Is This Course For:

This course is aimed at experienced engineering staff with responsibility for the control, operation or maintenance of installed high voltage systems and who may be appointed as Authorised Person (Electrical High Voltage). This course may also be used as an Authorised Person refresher course for the commercial sector. For those working to the HTM structure, you will require the Authorised Person High Voltage – HTM 06-03 course. For those working to JSP 375 Vol 3, you will require the Authorised Person High Voltage MOD Sectors course.

### Key Learning Areas Covered In This Course:

- Introduction to high voltage distribution systems
- High voltage switchgear types and operation
- Substation equipment
- Low voltage distribution systems
- Requirements for safe operation of high voltage systems
- Roles and duties of the Authorised Person
- Safe working procedures, HSG 85 or company safety rules
- Completion of safety documentation
- Operation and isolation of high voltage systems
- Introduction to protection systems
- Maintenance procedures regarding high voltage assets



# SAP High Voltage – Commercial and Industrial Sectors

📍 York and Slough | 5 Day | **£1,385**

APPHV4

## Course Overview:

This City & Guilds accredited course will enable you to gain the additional knowledge required to carry out Senior Authorised Person duties and responsibilities in order to achieve compliance with the requirements of the Electricity at Work 1989 and implement mandatory standards, such as company electrical safety rules. From attending this course you will gain a greater understanding of the role of the SAP.

**Please note: prospective delegates must have been appointed as an Authorised Person (High Voltage) within the last 5 years, OR be currently serving as a Senior Authorised Person (High Voltage). Proof will be required to attend the course.**

## Who Is This Course For:

This course is aimed at experienced HVAPs in the industrial and commercial sectors with the responsibility for the control, operation or maintenance of installed high voltage systems and who may be appointed as Senior Authorised Person (Electrical High Voltage). It is also suitable for existing High Voltage Authorised Persons looking for a HVSAP refresher. This course would be only suitable for those who are already appointed as APs or those who have recently completed the High Voltage Operation and Safety course

## Key Learning Areas Covered In This Course:

- Requirements for safe operation of high voltage systems
- Fault finding
- High voltage distribution switchgear and equipment
- High and Low voltage distribution systems
- High voltage working and operation
- Safe isolation around standby power supplies and equipment
- Roles and duties of the safety team, Appointments and Assessments
- Practical implementation of Safe Systems to establish safety rules
- Completion of safety documents through practical exercises
- High Voltage protection and Distribution Transformers
- Electricity at Work Safety Regulations 1989 and the published guidance available

Accommodation available from **£105** per night (including DBB)



## High Voltage Maintenance

📍 York and Slough | 5 Day | **£1,385**

### Course Overview:

This City & Guilds accredited course will enable you to gain the additional knowledge required to carry out inspection and maintenance of high voltage switchgear and associated systems.

Throughout this course receive hands-on practical training, led by our highly experienced training team, with practical sessions including; OCB maintenance, Fault finding, High voltage pressure testing, Secondary Injection testing for protection devices, Thermal Imaging, Partial Discharge Testing, Cable Location and Identification and Time Domain Reflectometry.

### Who Is This Course For:

This course is aimed at experienced staff such as managers and supervisors who have responsibility for the safety and maintenance of high voltage switchgear. It is particularly suitable for the High Voltage Competent Person and those who may be required to undertake inspection, maintenance and testing of high voltage equipment.

### Key Learning Areas Covered In This Course:

- Electricity at Work Regulations requirements for maintenance
- Recommendations for keeping electrical switchgear safe in accordance with HSG 230
- High voltage equipment including switchgear and protective devices
- Care and maintenance requirements for oil and non-oil circuit breakers
- Testing of earthing systems
- Maintenance of ancillary equipment
- Condition monitoring techniques
- Post maintenance checks including pressure testing
- Safe working procedures
- Practical exercises on high voltage assets

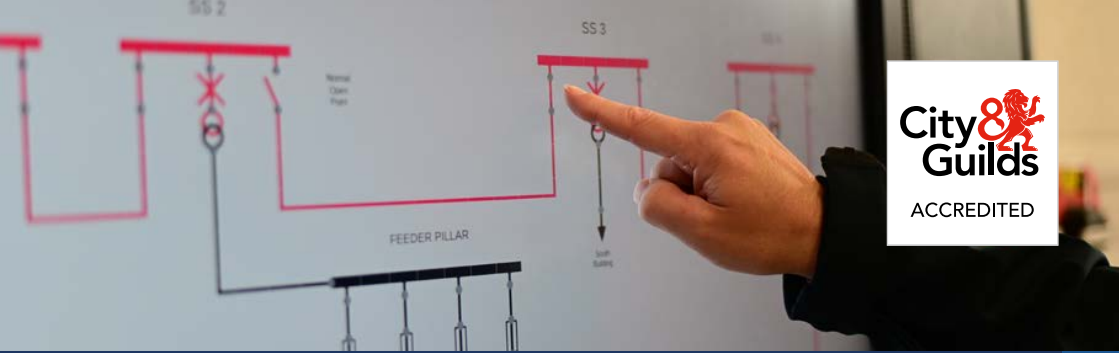

## High Voltage Awareness

📍 York, Slough and On-site | 2 Day | **£525**

### Course Overview:

This City & Guilds accredited course will enable you to gain an understanding of high voltage systems, equipment and the safe systems of work involved in their control and operation.

### Who Is This Course For:

This course has been designed for engineers who wish to gain an understanding of high voltage systems as well as for management with the responsibility for overseeing sites that contain high voltage electrical equipment.

This is an ideal pilot course for those considering High Voltage Authorised Person courses.

### Key Learning Areas Covered In This Course:

- Introduction to high voltage distribution systems
- High voltage switchgear types and operation
- Substation equipment
- Low voltage distribution systems
- Requirements for safe operation of high voltage systems
- Roles and duties of the Authorised Person
- Safe working procedures, HSG 85 or JSP 375 Volume 3 or company safety rules
- Completion of safety documentation
- Operation and isolation of high voltage systems
- Introduction to protection systems
- Maintenance procedures regarding high voltage assets

## High Voltage Technical

📍 York | 3 Day | £895

### Course Overview:

This course will provide you with the practical and theoretical awareness of the more technical aspects and use of high voltage systems and equipment. The aim of this course is to consolidate and enhance current knowledge and explore common engineering techniques.

### Who Is This Course For:

This course is aimed at engineering staff who work within high voltage environments, as either an Authorised Person, Competent Person or engineers within this discipline.

### Key Learning Areas Covered In This Course:

- Cables and testing
- Protection - schemes and methods
- Transformers - theory, selection and maintenance
- Earthing principles and testing
- Maintenance techniques
- Switchgear operation and testing



## Substation Entry Awareness

📍 York and Slough | 1 Day | £295

### Course Overview:

Access requirements for work such as painting, checking emergency lighting and servicing fire extinguishers, or escorting contractors such as gardening, pest control or cleaning all require an awareness of the environment and potential hazards inside substations. This City & Guilds accredited course looks at the dangers of electricity and hazards that could be encountered, what behaviour and control measures are required when entering these areas, the role of personnel and the type of documentation which could be used to gain access.

### Who Is This Course For:

Staff who may occasionally or regularly enter substations to do work (other than high voltage work) or to accompany an Authorised Person while high voltage working or testing is being carried out.

This course is suitable for those that need to understand the access requirements for work such as painting, checking emergency lighting and servicing fire extinguishers, or escorting contractors such as gardening, pest control or cleaning.

### Key Learning Areas Covered In This Course:

- Dangers of electricity
- Legislation
- Electricity at Work Regulations
- Roles and duties
- Documentation
- Switchgear and hazards
- Substation layouts and equipment
- Walk round a substation
- Risk assessments



Control panel area with digital display and indicator lights.

DORMAN SMITH

Airbreak

SOLID STATE  
11-12-13-14

ADD CONTACTS LTD  
1000 UNIVERSITY AVE  
TEL: 572-3333 FAX: 572-3370

AB4PB12500

11-1250A

1250A

1250A

1250A

1250A

1250A

1250A

1250A

1250A

1250A

1250A

1250A

1250A

1250A

1250A

1250A

1250A

1250A



WARRANTY SUPPLY  
MACHINE AIR

507

# Low Voltage



Course Name	Code	Length	Price Exc. VAT
Authorised Person Electrical Low Voltage	APLV	4 Day	£1,195
Skilled/Competent Person Electrical Low Voltage	CPLV	2 Day	£525
Standby Systems	STBS	3 Day	£895

Training available in York, Slough, Livingston and On-site



**"Great training experience."**

"Friendly & relaxing environment, lots to look at in the workshop and to be shown what each element does inline with the course."

Adam - Emscor UK

City & Guilds Accredited  
Authorised Person Electrical  
Low Voltage HTM 06-02  
Refresher

## Authorised Person Electrical Low Voltage

📍 York, Slough, Livingston and On-site | 4 Day | **£1,195**

### Course Overview:

The City & Guilds accredited Authorised Person Electrical Low Voltage course will enable you to gain the knowledge required to carry out Authorised Person duties and responsibilities in order to achieve compliance with the requirements of the Electricity at Work Regulations 1989, using JSP375 as the reference for safe procedures.

Please note we have the ability to offer this course on-site at client premises and on a bespoke basis.

### Who Is This Course For:

This course is aimed at experienced engineering staff within the MOD and Commercial sectors who may have responsibility for the control, operation or maintenance of installed low voltage systems and who may be appointed as Authorised Person (Electrical Low Voltage).

### Key Learning Areas Covered In This Course:

- Low voltage equipment including switchgear and protective devices
- Requirements of Electricity at Work Regulations
- Safe working practices with electricity (HSG85+JSP375)
- Safe isolation of standby power supplies and UPS equipment
- Roles and duties of personnel
- Low voltage working procedures
- Audit requirements
- Practical exercises in completion of safety documentation and hands on implementation
- Completion of log books and associated documentation





## Skilled/Competent Person Electrical Low Voltage

📍 York, Slough and Livingston | 2 Day | **£525<sup>+VAT</sup>**

GPLV

### Course Overview:

This City & Guilds accredited course will enable you to gain the knowledge required to carry out the role of Skilled/Competent Person (Electrical). It can also assist in demonstrating competence during the formal appointment process.

Please note we have the ability to offer this course on-site at client premises and on a bespoke basis.

### Who Is This Course For:

This course is aimed at electrical staff with responsibility for the operation or maintenance of installed low voltage systems and who may be nominated as a Competent/Skilled Person.

### Key Learning Areas Covered In This Course:

- Technical overview of electrical systems and protection concepts
- Awareness of electrical dangers
- Requirements of Electricity at Work Regulations
- Safe working practices with electricity
- Low voltage working procedures
- Receipt of safety documentation
- Practical exercises in isolation of low voltage equipment



# Standby Systems

📍 York and Slough | 3 Day | £895<sup>+VAT</sup>

STBS

## Course Overview:

This City & Guilds accredited course covers the key elements involved with the choice, use, and maintenance of Standby systems. The course provides an increased understanding of the Standby system types and topologies.

The Safe Systems element incorporates a tried and tested methodology with references to the JSP Safe Systems of Work, which can be adapted to the learner's own application.

## Who Is This Course For:

This course is aimed at the Authorised Person, engineer and technician seeking an overview of Standby systems. The course includes technical detail from manufacturers and OEMs and safe procedures referenced from HSE and other best practice libraries (including JSP)

## Key Learning Areas Covered In This Course:

- Generators
- UPS
- Topologies
- Safe working practices
- Isolation
- Regulations
- Compliances
- Roles of personnel
- Background and evolution of Standby systems
- Maintenance



52°

Kane-May KM330  
MAX  
70.6 °F  
ON 0.1°  
OFF 1°  
MAX °C  
HOLD °F

# Legionella Control and Management



Course Name	Code	Length	Price Exc. VAT
Legionella Management for Water Systems	WH001	1 Day	£295
Legionella Awareness	WH002	1 Day	£295
Legionella and Water Hygiene Control Within Hot and Cold Water Systems	WH003	3 Day	£895
Risk Assessment for Legionella and Water Hygiene Control in Water Systems	WH004	3 Day	£895
Disinfection of Hot and Cold Water Systems	WH005	1 Day	£295
Control of Legionella Within Evaporative Cooling Systems	WH006	3 Day	£895
Legionella Control Refresher and Update	WH007	1 Day	£295
Legionella Awareness Within Evaporative Cooling Systems	WH008	1 Day	£295
Written Scheme of Control - Implementation of the Monitoring Requirements for Hot and Cold Water Systems	WH009	1 Day	£295
Legionella Control and Management of Hot and Cold Water Services and Evaporative Cooling Systems	WH010	5 Day	£1,160
Introduction to The Risk of Pseudomonas aeruginosa and Other Waterborne Pathogens	WH011	1 Day	£315
Swimming and Hydrotherapy Pool Operation and Management	WH012	1 Day	£315
Servicing and Testing Requirements of Thermostatic Mixing Valves (TMV)	WH018	1 Day	£295
Closed Water Systems Awareness Course	WH013	1 Day	£295

Training available in York, Slough, Livingston and On-site



# Legionella Overview

## What is Legionella?

Legionella is a life-threatening bacterium which can be present in most environments where there is both natural and man-made water systems. The most common sources of infection are evaporative cooling systems, showers, taps, and spa baths.

## Reasons for Control of Legionella Bacteria

There is a growing need for building owners and managers to understand their duties and responsibilities as a legal requirement to identify and control the risk to building occupiers.

Under the Control of Substances Hazardous to Health Regulations, there is a requirement for the duty holder to carry out, or arrange for a risk assessment to identify if Legionella bacteria could multiply within water systems.

If there is an identified risk, then a Competent Responsible Person should be appointed to implement and manage a Written Scheme to control the risk. This written scheme should be managed to the minimum standard of the Approved Code of Practice L8 (ACoP L8) within HSG 274, or Health Technical Memorandum (HTM) 04-01.

Where a risk has been identified under ACoP L8 guidance, the Duty Holder is required to:

- Identify/assess the risks associated with the type of systems they manage
- Appoint a person to have managerial oversight - 'Competent Responsible Person'
- Prepare a written scheme to ensure that the risks are controlled and carry out checks in accordance with the scheme
- Ensure anyone involved in the control is competent and trained

## Who is at Risk?



45 Years +



Smokers



Lung Disease



Heavy Drinkers



Immune Deficiency



Heart Disease



Diabetes



Kidney Disease

# Which Course Do You Need?

## Find the Right Course for You and Your Employees

We have put together a quick guide to help you identify suitable course(s). For further guidance please visit our website or contact one of our Account Managers – 0333 121 0382

ACOP L8 ROLE	TYPICAL RESPONSIBILITIES	ACOP L8 RECOMMENDED POSITION	RECOMMENDED COURSES
<b>Duty Holder</b>	Risk assess existing buildings. If identified, appoint Competent Responsible Person	Employer, person in control of the premises or self employed	WH001 (page 48)
<b>Competent Responsible Person</b>	Implement and manage the Legionella Written Scheme. Ensure training and competency of all involved	Director or Senior Manager	WH001 (page 48), WH003 (page 50), WH010 (page 57)
<b>Risk Assessor</b>	Carry out risk assessment on water systems to identify the risk of building occupants	Risk Assessor	WH003 (page 50), WH004 (page 51), WH006 (page 53), WH010 (page 57), UHWS (page 64) WARE (page 65),



## Legionella Management for Water Systems

📍 York, Slough, Livingston and On-site | 1 Day | £295

### Course Overview:

This City & Guilds accredited course provides the necessary information for you to understand the duties and responsibilities of the Duty Holder and appointed Competent Responsible Person. It will cover the supervision, effective implementation and management of Legionella risk assessments, along with remedial work and management of water systems within buildings to help you comply with Approved Code of Practice L8.

We also offer this course as a online remote training course.

### Who Is This Course For:

This course has been designed for the Duty Holder or an Appointed Competent Person(s) responsible for the control of Legionella bacteria within water systems.

### Key Learning Areas Covered In This Course:

- Legionellosis - background - medical aspects - case studies
- Legal implications
- ACOP L8 and guidance on the control of Legionella in water systems
- Implementation of the written scheme
- Water sampling and necessary actions
- Ensuring competency of staff, consultants and contractors
- Water systems disinfection requirements
- Management of log book records
- Course assessment





# Legionella Awareness

WH002

📍 York, Slough, Livingston and On-site | 1 Day | £295

## Course Overview:

This City & Guilds accredited Legionella Awareness course is an entry-level qualification which will provide an insightful background to Legionella - covering its risks, the monitoring requirements and the statutory legislation surrounding it. Once you successfully complete this 1-day legionella awareness training you will have an understanding of why it's necessary to successfully implement and manage a written scheme, monitor for legionella and ensure your water systems are ACOP L8 Compliant.

We also offer this course as a online remote training course.

## Who Is This Course For:

This Legionella awareness course has been designed as an entry point for anyone that needs to gain knowledge of Legionella and understand the importance of managing the risks. This course has been developed in line with ACOP L8 and relevant Statutory requirements, ensuring that you will receive up to date information on industry standards. Completion of our City & Guilds accredited Legionella Awareness course can open up a path towards becoming more involved with water hygiene related duties, whilst providing formal recognition of your skills and knowledge.

## Key Learning Areas Covered In This Course:

- Water systems safety
- Legionellosis - medical aspects - case studies
- Applicable statutory documentation
- Requirements of the ACOP L8 and other technical support documents
- An awareness of the Written Scheme of Control
- Monitoring requirements of hot and cold water systems
- Flushing regimes
- Water sampling requirements
- Records and log books
- Course assessment



## Legionella and Water Hygiene Control Within Hot and Cold Water Systems

WH003

📍 York, Slough, Livingston and On-site | 3 Day | £895

### Course Overview:

This City & Guilds accredited course will provide you with an understanding of how to control the risk from legionella bacteria within hot and cold water systems. It will enable effective management of the hot and cold water system in accordance with the Approved Code of Practice (ACOP) L8 and guidance document HSG274 Part 2.

### Who Is This Course For:

This course is ideal for managers, supervisors or engineers who require knowledge of how to prevent and control legionella bacteria in the hot and cold water systems they are responsible for.

Delegates undertaking this course who need the disinfection element can book both our, "Disinfection of Hot and Cold Water Systems" and this three day legionellosis course, with both courses running consecutively.

### Key Learning Areas Covered In This Course:

- Legionellosis - background - medical aspects - case studies
- Relevant statute documents - legal implications
- The requirements of Approved Code of Practice L8
- Other technical support documents
- Potential mechanical and bacterial hazards from a hot/cold system
- Hot and cold water system design
- Requirements of the Written Scheme of Control
- Implementing the Written Scheme of Control, including monitoring requirements
- Water sampling requirements and subsequent actions
- Compiling and managing the legionella water hygiene log book
- Course assessments



# Risk Assessment for Legionella and Water Hygiene Control in Water Systems

📍 York, Slough, Livingston and On-site | 3 Day | £895

## Course Overview:

This City & Guilds accredited course will provide you with knowledge of how to assess the risk of being exposed to the legionella bacteria in water systems, including how to document the findings. Delegates will ideally have a prior knowledge of water systems.

## Who Is This Course For:

This course has been developed for those who would like to become legionella risk assessors, or who need an understanding of the risk assessment process within mechanical water systems.

## Key Learning Areas Covered In This Course:

- Legionellosis - background - medical aspects - case studies
- A review of statute and legal responsibilities
- Risk assessment in relation to the ACOP L8 and BS8580
- Identifying susceptible areas in high risk water systems, in particular hot and cold water systems and evaporative cooling systems.
- Modification of water systems to eliminate/reduce the risk of legionellosis
- Written scheme requirements in accordance with ACOP L8 and BS8580
- Water sampling methods and required actions
- Risk assessment documentation
- Course assessments



## Disinfection of Hot and Cold Water Systems

📍 York, Slough, Livingston and On-site | 1 Day | £295

### Course Overview:

Our one day City & Guilds accredited disinfection of hot and cold water systems course has been designed to provide you with the statutory, technical and practical information required to safely disinfect hot and cold water systems. Taught by industry professionals, throughout this course you will develop a thorough understanding of water system disinfection in accordance with technical documents: HSG274 Part 2, BS 8558 and PD855468. Upon completing this course, you will know which chemicals to use and how to disinfect safely. This includes disinfection procedures using; sodium hypochlorite, hydrogen peroxide, as well as subsequent water sampling and chemical measurement.

### Who Is This Course For:

This Legionella disinfection course has been developed for those planning or currently involved with the disinfection of hot and cold water services within buildings using chlorine based compounds or silver stabilised hydrogen peroxide.

Possessing a City & Guilds accredited Legionella disinfection certification will further expand your skillset and can open up a path towards becoming more involved with the technical side of Legionella and water related duties. Additionally, our City & Guild accredited course is widely recognised across the UK, providing formal recognition of your skills and knowledge.

### Key Learning Areas Covered In This Course:

- Legal and moral framework
- Storage and handling of chlorine silver hydrogen peroxide chemicals
- Biocidal treatment methods
- Calculating system capacities and chemical quantities
- Chemical dose, pH factor and residual measurement
- De-chlorination methods
- Disinfection procedures
- Water sampling
- Course assessment



## Control of Legionella Within Evaporative Cooling Systems

📍 York, Slough and On-site | 3 Day | £895

WH006

### Course Overview:

This City & Guilds accredited Legionella course focuses on how to control Legionella within evaporative cooling systems. The course has been developed to ensure that you understand the unique risks posed by an evaporative cooling system and how to successfully control the proliferation of Legionella. Throughout this course you will go through the relevant statutory legislation, be shown the areas of high risk within wet cooling system designs and the subsequent disinfection, maintenance and record keeping. Upon completing this course, you will be able to effectively manage evaporative cooling systems in accordance with the Approved Code of Practice (ACOP) L8 and guidance document HSG274 Part 1, reducing the risk of Legionella within your facility.

### Who Is This Course For:

This Legionella training course has been designed to support anyone that currently or plans to work/manage evaporative cooling systems. Due to the industry demand for knowledgeable and suitably trained technicians and management who understand Legionella control within evaporative cooling systems, this course is perfect for anyone wanting to ensure its effective management and operation. This is a great follow-on course for anyone wanting to up-skill and expand their Legionella training to include more specialised water systems often seen within larger facilities. Expanding your portfolio to include additional City & Guilds Legionella qualifications provides formal recognition of your skills and knowledge and can provide new opportunities to progress into other roles within the facility management industry.

### Key Learning Areas Covered In This Course:

- Legionellosis - medical aspects - case studies
- Relevant statute documentation | Approved Code of Practice L8 and HSG274 Part 1
- Wet cooling system design, operation and maintenance requirements
- Water treatment requirements | cleaning and disinfection of water/cooling systems
- The requirements of monitoring systems
- Water sampling requirements and subsequent actions
- The requirements of compiling and maintaining the water management log book
- Course assessments



## Legionella Control Refresher and Update

📍 York, Slough, Livingston and On-site | 1 Day | £295

### Course Overview:

This City & Guilds accredited course will provide you with the latest changes and updates to relevant legislation and the Approved Code of Practice (ACOP) L8, along with a refresher on the required management of legionella in water systems.

### Who Is This Course For:

This course is specifically for anyone who has completed a course on Legionella control and now find it necessary to update themselves on the requirements of the Approved Code of Practice L8, or changes on how the risk is controlled.

### Key Learning Areas Covered In This Course:

- Legionella/Legionellosis – update and recent changes
- Relevant statute documents and legal implications
- ACOP L8 & HSG274s and relevant technical support documents
- Water Safety Plan – written scheme of control
- Risk systems including Hot and Cold Water Services and Evaporative Cooling Systems
- Implementing and monitoring the written scheme of control
- Water sampling and subsequent actions
- Water hygiene/management log book
- Written question paper

## Legionella Awareness Within Evaporative Cooling Systems

📍 York and Slough | 1 Day | £295

### Course Overview:

Understand the risk of Legionella bacteria within an evaporative cooling tower system with our one day City & Guilds accredited course. This Legionella awareness course will provide you with the knowledge of how bacteria proliferate within evaporative cooling systems and the monitoring requirements needed for its control. Our experienced training team will guide you through the appropriate ways of monitoring the systems effectively and in accordance with Legionnaires' Disease Technical Guidance HSG274 Part 1, Approved Code of Practice (ACOP) L8 and other relevant guidance documents.

This theory based course will not only help you develop an understanding of the systems which pose the highest risks but also to how correctly document them.

### Who Is This Course For:

Our course has been designed for engineers and technicians who are looking for an understanding of Legionella within evaporative cooling systems along with the associated guidance documents to ensure compliance. Documents which will be covered in this course includes: the Approved Code of Practice (ACOP L8) and BS8580 (Water Quality. Risk Assessments for Legionella Control Code of Practice). Upon successful completion of this course you will be awarded a City & Guilds accredited certificate which provides formal recognition of your skills and knowledge.

### Key Learning Areas Covered In This Course:

- Medical aspects of legionnaires disease, including how the bacteria proliferates and identifying susceptible people to the illness
- Relevant statutory and non-statute guidance documents
- The requirements of Approved Code of Practice L8 to ensure compliance
- Requirements of cleaning and disinfection of cooling towers
- Monitoring checks to ensure effective water treatment programme
- Monitoring requirements including temperature checking, inspections water sampling and actions in the event of positive count
- Requirements of compiling and maintaining the water management log book
- Written assessment

## Written Scheme of Control – Implementation of the Monitoring Requirements for Hot and Cold Water Systems

📍 York, Slough and Livingston | 1 Day | £295

### Course Overview:

Gain an understanding of why water systems require close monitoring, forming the Water Hygiene Written Scheme of control for your site/building with our 1-day theory and practical based training course.

This course will provide you with the knowledge to perform water system tasks in a safe and effective manner. This course is designed to align with statutory requirements and the Approved Code of Practice (ACoP L8) and HSG274 part 2.

### Who Is This Course For:

Our course will support those working within: maintenance, technician, building caretaker and operator roles. It is also suitable for those who carry out temperature monitoring, water sampling, shower head cleaning, flushing and inspections of hot and cold water services as part of the Written Scheme of Control. This course can also be beneficial to managers and supervisors for an insight into these water safety tasks.

### Key Learning Areas Covered In This Course:

- Background on the hazards and health risks which are associated with hot and cold water systems
- Statute and regulatory requirements
- Requirements of the Approved Code of Practice (ACoP L8) Control of Legionella bacteria in water systems
- Monitoring and inspection requirements of hot and cold water services as per HSG274 part 2
- Showerhead descaling and cleaning requirements
- Water sampling protocols and procedures
- Record keeping log books
- Practical demonstrations
- Written assessment



## Legionella Control and Management of Hot and Cold Water Services and Evaporative Cooling Systems

📍 York, Slough, Livingston and On-site | 5 Day | **£1,160**

### Course Overview:

This City & Guilds accredited course has been developed to provide you with an understanding of how to control the risk of legionella within a water system, and evaporative cooling system. It will enable management of the water system in accordance with the Approved Code of Practice (ACOP) L8 and guidance document HSG274 Parts 1, 2 and 3.

### Who Is This Course For:

This course is for managers, supervisors and engineers who require an in-depth understanding of how water systems become contaminated with legionella bacteria, and other pathogens. As well as, how implementing good management processes can help mitigate the risk to health.

### Key Learning Areas Covered In This Course:

- Legionella/Legionellosis - ecology and epidemiology - case studies
- Other health risks associated with Hot and Cold Systems
- Relevant statute documents and legal implications
- ACOP L8 and other technical support documents
- Water Safety Plans - written scheme of control
- Hot and Cold Water Systems - hazards - risks - remedial actions
- Evaporative Cooling Systems - hazards - risks - remedial actions
- Water treatment programmes
- Implementing and monitoring the written scheme of control
- Disinfection of Hot and Cold Evaporative Cooling Systems
- Water sampling systems
- Compiling and maintaining water management log books
- Course assessments

# Introduction to The Risk of Pseudomonas aeruginosa and Other Waterborne Pathogens

📍 York, Slough, Livingston and On-site | 1 Day | £315

## Course Overview:

Our 1 day City & Guilds training course will introduce you to Pseudomonas aeruginosa - its risks, habitat and subsequent control methods. This course has been designed to provide a proactive solution to Pseudomonas aeruginosa rather than a reactive approach. We will provide you with an understanding of effective hygiene practice and water management to ensure the risk of Pseudomonas aeruginosa is kept to a minimum. The course will align with BS8580-2 Risk Assessments for Pseudomonas aeruginosa and other waterborne pathogens - CoP.

Upon completing this course you will have gained a more informed understanding and increased knowledge of Pseudomonas aeruginosa to help in carrying out water risk assessments in a healthcare environment and contributing to the Water Safety Plan.

## Who Is This Course For:

This Pseudomonas aeruginosa training course has been designed as an entry point for anyone needing to further their water hygiene knowledge to include other waterborne pathogens. This course has been developed inline with HTM 04-01, and BS58580-2 ensuring that you have the most up to date knowledge and is directly applicable to the healthcare environment.

## Key Learning Areas Covered In This Course:

- An introduction to Pseudomonas aeruginosa
- A clinical understanding of Pseudomonas aeruginosa
- Requirements of HTM 04-01 Part C
- Understanding the requirements of BS58580-2 in the water risk assessment process
- Pseudomonas aeruginosa in the environment
- Control of Pseudomonas aeruginosa in hot and cold water systems
- Sampling methods for Pseudomonas aeruginosa and subsequent actions
- Course assessment

# Swimming and Hydrotherapy Pool Operation and Management

📍 York, Slough and On-site | 1 Day | £315

## Course Overview:

This City & Guilds accredited course will provide you with an understanding of how to control the health risks associated with swimming and hydrotherapy pools by effective management and maintenance of pool water quality.

## Who Is This Course For:

This course is designed for managers, supervisors and technicians who require an understanding of the importance of managing and maintaining swimming and hydrotherapy pools.

## Key Learning Areas Covered In This Course:

- Swimming/Hydrotherapy pools - health hazards - case studies
- The risk to users from swimming pool water and the reasons for pool water management
- Relevant statutory documents - legal obligations
- Relevant technical support documents
- Common methods of swimming and hydrotherapy pool treatment
- Swimming and hydrotherapy pool maintenance requirements
- Pool water monitoring requirements including pH and chemical testing to ensure pool water quality
- Fault finding - corrective actions
- Course assessment



## Closed Water Systems Awareness Course

📍 York, Slough and Livingston | 1 Day | £295

### Course Overview:

Gain an insightful understanding of closed water systems with our 1-day awareness course.

This comprehensive course covers a wide range of technical and legal guidance including Health and Safety Executive (HSE), Building Services Research Information Association (BSRIA) and British Standards.

Further to this, our comprehensive course provides you with the essential background knowledge needed to work on closed water systems along with their requirements and functions.

### Who Is This Course For:

Our course has been designed for a range of job roles including facilities managers, water treatment engineers/technicians, landlords, maintenance staff and contractors. This course will support all roles which have responsibility for the installation, maintenance and monitoring of commercial and industrial closed water systems.

### Key Learning Areas Covered In This Course:

- Closed water systems; types, function and requirements
- Legal aspect - relevant statute documents
- technical guidance documents - HSE guidance document, BSRIA guides and BS guides
- Types of closed water systems: Low to high pressure temperature systems - closed condenser water systems, chilled water systems and closed-loop systems
- Aspects affecting closed water systems - Types of pipework used and corrosion issues caused by chemicals and bacteria
- Water treatment chemicals
- Water analysis and recording processes
- Written course assessment

# Servicing and Testing Requirements of Thermostatic Mixing Valves (TMV)

📍 York, Slough, Livingston and On-site | 1 Day | £295

WH018

## Course Overview:

This City & Guilds course will equip you with the knowledge to commission, service and test thermostatic mixing valves in-line with legal and advisory guidelines (including HTM requirements for the healthcare sector).

This is a theory based training course, with some practical demonstrations carried out by our knowledgeable and experienced tutors.

## Who Is This Course For:

This course is aimed at those who are involved in the servicing and testing of Thermostatic Mixer Valves (TMVs).

## Key Learning Areas Covered In This Course:

- The background to general water systems safety
- Hot water systems and potential scalding hazards
- Legal and advisory documents including Health Technical Memorandum (HTM 04-01) requirements
- Point of use mixing
- Group centralised mixing
- Correct use and testing of digital thermometers
- Commissioning, servicing and testing of thermostatic valves (theory) with respect to correct temperature and fail-safe testing
- Recording information
- Course assessment



PRESSURE

# Water Hygiene

**bpec**  
LEARNING FOR LIFE

Course Name	Code	Length	Price Exc. VAT
Unvented Hot Water Storage	UHWS	1 Day	£335
Water Regulations	WARE	1 Day	£335

Training available in York, Slough and On-site



★★★★★

## "Exceptional Training Provider"

"The Water Regs Course was expertly delivered by trainers with a wealth of knowledge and supported by well presented reference material. The course is delivered in a modern, clean, comfortable and well equipped building."

Jason - University Partnerships Programme

BPEC  
Water Regulations



## Invented Hot Water Storage

📍 York and Slough | 1 Day | £335

### Course Overview:

Part G3 of the building regulations states that it is a legal requirement that all domestic vented and unvented hot water systems are maintained by a qualified person. On successful completion of this course you will be certified for five years to install, service and commission domestic hot water systems in the UK.

You must place your booking 14 days before the start date of the course.

### Who Is This Course For:

This BPEC accredited course is aimed at plumbers and heating engineers who wish to gain the relevant certification to enable them to install, service or commission domestic hot water systems in the UK. To be eligible you must:

You MUST be able to provide evidence of one of the following BEFORE attending the course:

Hold a formal craft qualification e.g. National or Scottish Vocational Qualification (NVQ/ SNVQ ) Level 2 or 3 in heating engineering or plumbing

OR

Have a number of years' experience in either conventional heating engineering or plumbing ( Please supply evidence to support this statement )

OR

Currently undertaking a course in heating engineering or plumbing which will lead to a formal qualification, such as NVQ level 2 or 3 heating and ventilation or plumbing

### Key Learning Areas Covered In This Course:

- Unvented hot water systems and their operating principles
- Design and installation of unvented hot water storage systems
- Maintenance of unvented hot water storage systems
- Requirements of the Building Regulations Part L1 -conservation of fuel and power
- Sealed central heating systems
- Practical fault finding
- Course assessments





# Water Regulations

WARE

📍 York, Slough and On-site | 1 Day | £335

## Course Overview:

On successful completion of this BPEC accredited course you will be able to apply to be an approved contractor for water regulation purposes. This means that you can self-certify your plumbing work and also work for housing associations and other various non-government bodies. You will also be able to join the WIAPS Approved Plumbers Scheme providing you hold other relevant certificates.

You must place your booking 14 days before the start date of the course.

## Who Is This Course For:

This course is aimed at practising plumbers working to water regulation requirements. It covers the knowledge required to be assessed on the BPEC Water Regulation certificate.

## Key Learning Areas Covered In This Course:

- Introduction, background and legislation to UK Water Regulations
- Materials and substances in contact with water
- Requirements for water fittings
- Water system design
- Installation commissioning
- Cross connections
- Back flow prevention
- Hot and cold water services
- WCs and urinals
- Sanitary appliances and water for outside use
- Course assessment

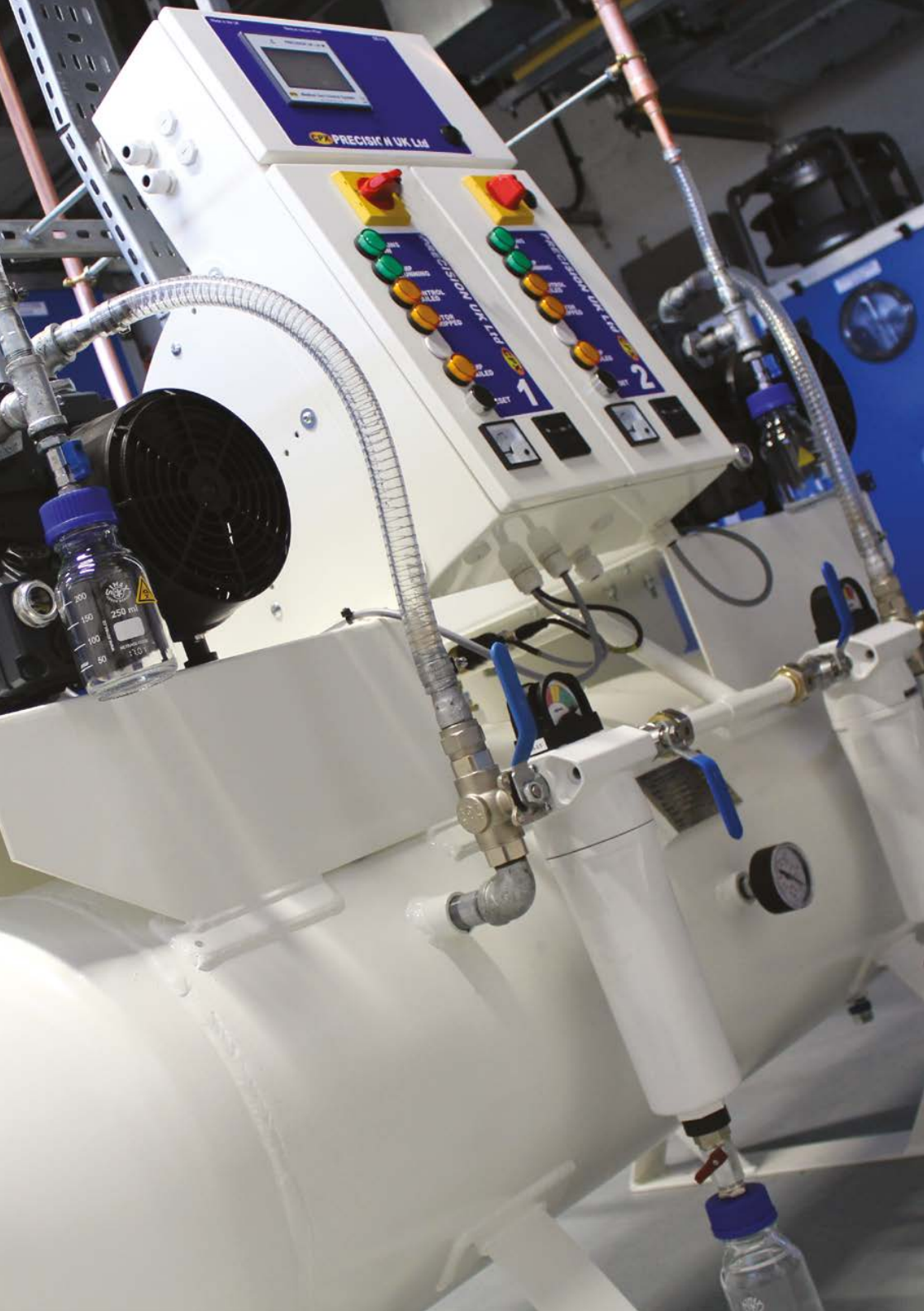

PRECISION UK Ltd

PRECISION UK Ltd  
CONTROL PANEL  
1

PRECISION UK Ltd  
CONTROL PANEL  
2

250 ml  
100  
50  
100  
150  
200  
250

Pressure Gauge

# Medical Gas Pipeline Systems HTM 02-01



Course Name	Code	Length	Price Exc. VAT
Authorised Person Medical Gas Pipeline Systems HTM 02-01	APMGPS	5 Day	£995
Authorised Person Medical Gas Pipeline Systems Refresher HTM 02-01	APMGPSR	3 Day	£795
Competent Person Medical Gas Pipeline Systems HTM 02-01	CPMGPS	5 Day	£995
Competent Person Medical Gas Pipeline Systems Refresher HTM 02-01	CPMGPSR	3 Day	£795
Dental Compressed Air and Vacuum Systems for use in Healthcare	DAVS	2 Day	£525

## Training available in York and Slough



### "Really Enjoyed The Course"

"Very informative & presented in a way I think all should do. People would learn more if taught the way you do so.

Best course I've been on in my 14 years with the NHS, excellent thanks."

Dave - Northern Care Alliance NHS Group

City & Guilds Accredited  
Authorised Person Medical Gas Pipeline Systems Refresher HTM 02-01

# Our Facilities

## Medical Gas Pipeline Systems

### York Campus

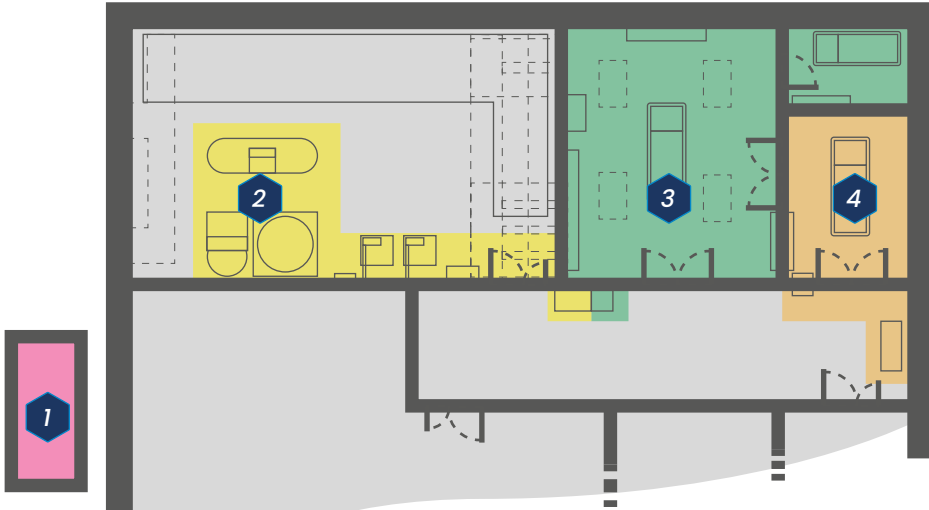

### The Importance of Practical Training

Our practical facilities showcase industry standard installations, enabling delegates to gain hands-on experience in the testing and commissioning of equipment found in plant rooms, conventional theatres and anaesthesia rooms, all compliant with HTM 02-01.

By attending either of our AP or CP courses, you will gain transferable skills and knowledge to be able to carry out your duties compliantly and enable you to react effectively to emergency situations, should they arise.



#### Medical Gas Manifold Supply

Designed to mimic the medical gas supply for a HTM 02-01 compliant manifold room. The supply consists of:

- Medical Air Emergency Reserved Manifold
- Medical Air Automatic Manifold



#### Medical Gas Plant Room

For use as a practical teaching aid in our AP and CP courses. This room holds:

- Central Alarm System
- 3 Phase Anaesthetic Gas Scavenging System
- Duplex Medical Vacuum Plant
- Duplex Medical Air Plant
- Ventilation Plant Equipment

## Slough Centre

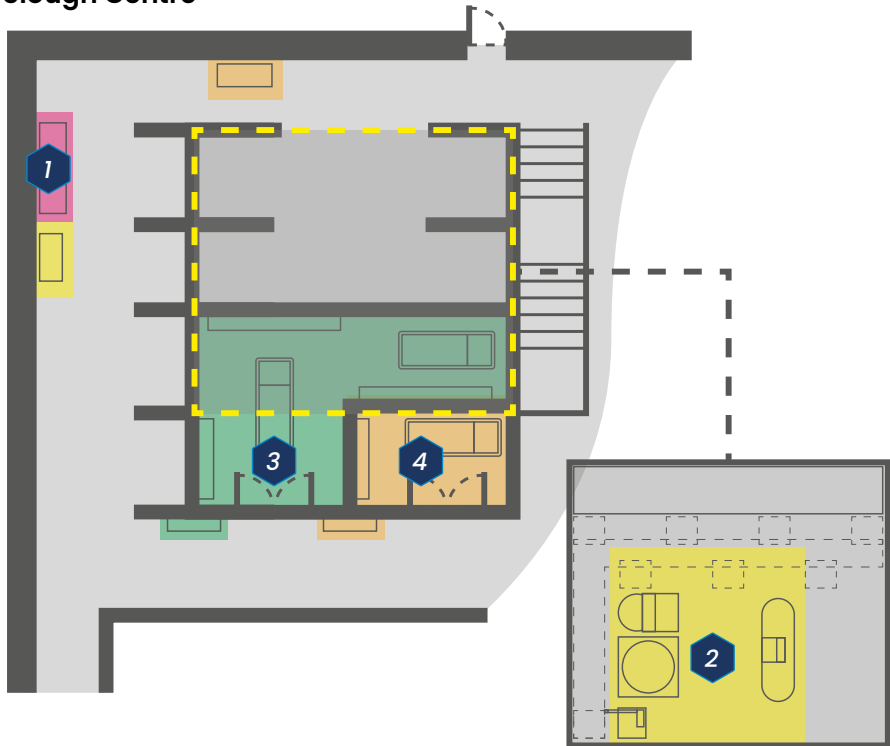

3

### Conventional Theatre and Recovery Room

Where delegates require knowledge of real-world applications of medical gases, these rooms contain:

- 2X 3 Gas, Surface Mounted AVSU Module with Digital Alarm and Transducers
- 6 Gas, Surface Mounted AVSU Module with Digital Alarm and Transducers
- Local Alarm
- Various Terminal Units

4

### Anaesthesia Room

Along with the Theatre and Recovery rooms, this area is designed to enable testing and commissioning practical works, and holds:

- Duplex 3 Gas, Surface Mounted AVSU Module with Digital Alarm and Transducers
- 3 Gas, Surface Mounted AVSU Module with Digital Alarm and Transducers
- Dental Air Compressor
- Various Terminal Units

# Our Facilities

## Medical Gas Manifolds



### **Automatic Changeover Manifold**

*MA4 Automatic Change Over Manifold- 650 l/min  
Digital- 2x4 Pin Index, c/w Digital Touchscreen*

This manifold is classified by HTM 02-01 as a primary supply. According to this Health Technical Memorandum, manifold type, capacity and location of all primary, secondary and reserve sources of supply must all be carefully considered and risk assessed during the planning stage, taking into account specific design parameters and need for supply security.



### **Emergency Reserved Manifold (ERM)**

*Emergency Reserved Manifold MA4 to HTM 02-01 -  
2x2 Pin Index.*

This manifold is classified by HTM 02-01 as a secondary supply. This must come online automatically via a non-return valve. The number of cylinders must provide a minimum of 4 hours supply, based on the facility's design flowrates. A compressor plant, or synthetic air supply, should always be specified where capacity is in excess of a 2 x 10 manifold capacity.



### **Back-feed Kit**

*Backfeed protection device*

The back-feed kit is used to supply the medical gases to a ward or department in the event of a main supply interruption and is connected via the NIST or through a terminal unit. This is to be undertaken with the implementation of a permit to work and under the control of the Authorised Person. The back-feed kits are gas specific and are manufactured to be connected to all types of gases.

# Our Facilities

## Medical Gas Plant



### Active Anaesthetic Gas Scavenging System (AAGSS)

*AGSS Simplex Unit - 260l/min 3 phase*

The AAGSS is used for the extraction of the waste anaesthetic gas from the patient breathing circuit ensuring compliance to the CoSHH regulations for the theatre environment. The system is extended into the theatre and anaesthetic room to enable practical testing and commissioning for both the APs and CPs.



### Medical Vacuum Plant

*Med Vac Plant 270l/min Duplex - HTM 02-01, c/w Digital Touchscreen*

Classified as a primary source only, this duplex plant will work in conjunction with a third pump to meet the supply recommendations of HTM 02-01.

The use of medical vacuum plant systems for providing dental vacuum is not advised according to HTM 02-01.



### Medical Air Plant

*Med Air Plant 420l/min Duplex - HTM 02-01 c/w Digital Touchscreen*

Working in conjunction with our ERM, this duplex system supplies medical air to our theatre, recovery and anaesthesia rooms. Sited with all-round access for maintenance purposes and allowing adequate flow for air intake to the compressors.



### Dental Air Plant

*Silent Running -44 Dew Point  
HTM 2022 Compliant*

The dental system is a self-contained package including the compressor and twin desiccant dryer system, integral to the single cabinet. This system can cater for a single chair to 20 chair installation. Also used to run sterilisation and pharmaceutical supply within Medical Gas Pipeline Systems.



## Authorised Person Medical Gas Pipeline Systems HTM 02-01

📍 York and Slough | 5 Day | £995

### Course Overview:

This City & Guilds accredited course provides you with a detailed overview and understanding of HTM 02-01. Attending this course enables you, as a prospective AP (MGPS), to carry out your duties effectively and compliantly with respect to medical gas systems. This will also cover your ability to react correctly to emergency situations. During the course, you will take a number of written assessments and a multiple choice examination. Upon successful completion, you will be issued with a City & Guilds accredited certificate of achievement.

### Who Is This Course For:

This course is designed for healthcare/estates officers and other personnel, who are looking to be appointed as an Authorised Person (MGPS) and require a detailed level of understanding that ensures they have the knowledge and competence to manage a medical gas system safely to compliance.

### Key Learning Areas Covered In This Course:

- Understanding of the HTM 02-01 and its structure and purpose
- Statutory requirements
- Characteristics and safety requirements of medical gases
- Storage and management of medical gas cylinders
- Correct use and management of the medical gas permit to work system
- Management and assessment of Competent Persons and medical gas contractors
- Safe management of medical gas plant and distributional pipework systems
- Design overview and installation practices of medical gas systems
- Validation and verification of medical gases
- Overview of an Operational Policy and Safe Operating Procedures
- Requirements of the Medical Gas Group
- Management of documentation
- Compliant management of medical gas maintenance
- The provision of emergency supplies
- Risk assessments and method statements



# Authorised Person Medical Gas Pipeline Systems Refresher HTM 02-01

📍 York and Slough | 3 Day | £795

APMGPSR

## Course Overview:

This City & Guilds accredited course is a condensed version of our full Authorised Person medical gas pipeline systems course. Attending this course enables you, as a prospective AP (MGPS), to carry out your duties effectively and compliantly with respect to medical gas systems. This will also cover your ability to react correctly to emergency situations. During the course, you will take a number of written assessments and a multiple choice examination. Upon successful completion, you will be issued with a City & Guilds accredited certificate of achievement.

## Who Is This Course For:

This course is designed for Authorised Persons (MGPS) who are currently an AP within a healthcare facility and have been for a minimum of three years. This course is an intensive course suitable for those, who along with taking the role and responsibility, have a good knowledge of their system, the requirements and general principles of pipeline systems.

## Key Learning Areas Covered In This Course:

- Understanding of the HTM 02-01 and its structure and purpose
- Statutory requirements | Characteristics and safety requirements of medical gases
- Storage and management of medical gas cylinders
- Correct use and management of the medical gas permit to work system
- Management and assessment of Competent Persons and medical gas contractors
- Safe management of medical gas plant and distributional pipework systems
- Design overview and installation practices of medical gas systems
- Validation and verification of medical gases
- Overview of an Operational Policy and Safe Operating Procedures
- Requirements of the Medical Gas Group and management of documentation
- Compliant management of medical gas maintenance
- The provision of emergency supplies
- Risk assessments and method statements



## Competent Person Medical Gas Pipeline Systems HTM 02-01

📍 York and Slough | 5 Day | £995

### Course Overview:

This City & Guilds accredited course has been designed to provide a comprehensive and in-depth knowledge and understanding of safety and compliance when working with medical gas systems. Throughout this course HTM 02-01 will be covered in-depth to enable you to understand your role and responsibilities.

This course is made of 2 assessments, a scenario and a multiple-choice examination. Upon successful completion of the written assessment, you will be issued with a City & Guilds accredited certificate of achievement which can be presented to your authorising party for appointment.

### Who Is This Course For:

This course has been designed for healthcare/estates officers and other personnel, who are looking to be appointed as a Competent Person (MGPS) and require a detailed level of understanding to work with medical gas systems, safely and compliantly.

### Key Learning Areas Covered In This Course:

- Understanding of the HTM 02-01 and its structure and purpose
- Typical Gas System design and operation
- Understanding of gas system schematic diagrams
- Basic fault finding, including typical responses to alarm/ emergency conditions
- MGPS Maintenance and Testing Requirements, including practical tests
- Introduction to the MGPS Permit to Work System, as detailed within HTM 02-01
- Emergency Procedures

# Competent Person Medical Gas Pipeline Systems Refresher HTM 02-01

📍 York and Slough | 3 Day | £795

CPMGPSR

## Course Overview:

This course provides you with an overview and a reminder of what is required within HTM 02-01. Attending this course allows you, as a prospective CP (MGPS), to carry out your duties effectively concerning medical gas supply plant and all medical gas distribution systems. This also covers your ability to react correctly to emergency situations. Upon successful completion of the written assessment, you will be issued with a City & Guilds accredited certificate of achievement.

## Who Is This Course For:

This course has been developed for those already appointed as the Competent Person (MGPS) within a healthcare facility and have been for a minimum of three years. This course is an intensive course suitable for those who have a good knowledge of their system, the requirements and general principles of pipeline systems.

For CPs that have infrequent contact with medical gas pipeline systems, we recommend our full 5 day course.

## Key Learning Areas Covered In This Course:

- Introduction to basic gas safety and HTM 0201
- Typical Gas System design and operation
- Understanding of gas system schematic diagrams
- Basic fault finding, including typical responses to alarm/ emergency conditions
- MGPS Maintenance and Testing Requirements, including practical tests
- Introduction to the MGPS Permit to Work System, as detailed within HTM 0201
- Emergency Procedures



## Dental Compressed Air and Vacuum Systems for use in Healthcare

📍 York and Slough | 2 Day | £525

### Course Overview:

Our City and Guilds accredited Dental Air and Vacuum Systems (DAVS) course provides a detailed overview of the managing documents HTM02-01 and HTM2022 Supplement 1. The course will cover all the knowledge that is required to work on and manage a Dental Air and Vacuum System (DAVS).

It will specifically cover legislation, installation, maintenance, and management of the systems, as well as compliance with the requirements of HTM 02-01 and HTM 2022 Supplement 1. The course has both theory and practical elements with a scenario and examination at the end. Those who attend and successfully complete the course and pass the examination will receive a City & Guild accredited certification of achievement.

### Who Is This Course For:

The course is designed for healthcare/estates/private facilities that work with Dental Air or Vacuum systems, or the management, maintenance, or installation of these systems. You must have a professional level of understanding and knowledge to be involved with a DAVS system; this course will enable you to achieve this. This qualification is a requirement for those responsible for or working on a DAVS system.

### Key Learning Areas Covered In This Course:

- Introduction to Medical Gases
- Personal Protective Equipment (PPE)
- General Principles of Dental Air and Dental Vacuum
- History of Dentistry and Air Compressors
- Management Responsibilities and Guidelines
- Regulations and Legal Responsibilities in line with CQC, HSE, HTM 2022 Supplement 1, PSSR and JSP 375 | Statutory Requirements
- System Design and Operational Procedures | Permits to Work
- Modification of Existing Dental Air Systems
- Commissioning (Validation and Verification)
- An overview of Electrical supply requirements
- Practical Demonstration | Assessed scenario work and final examination



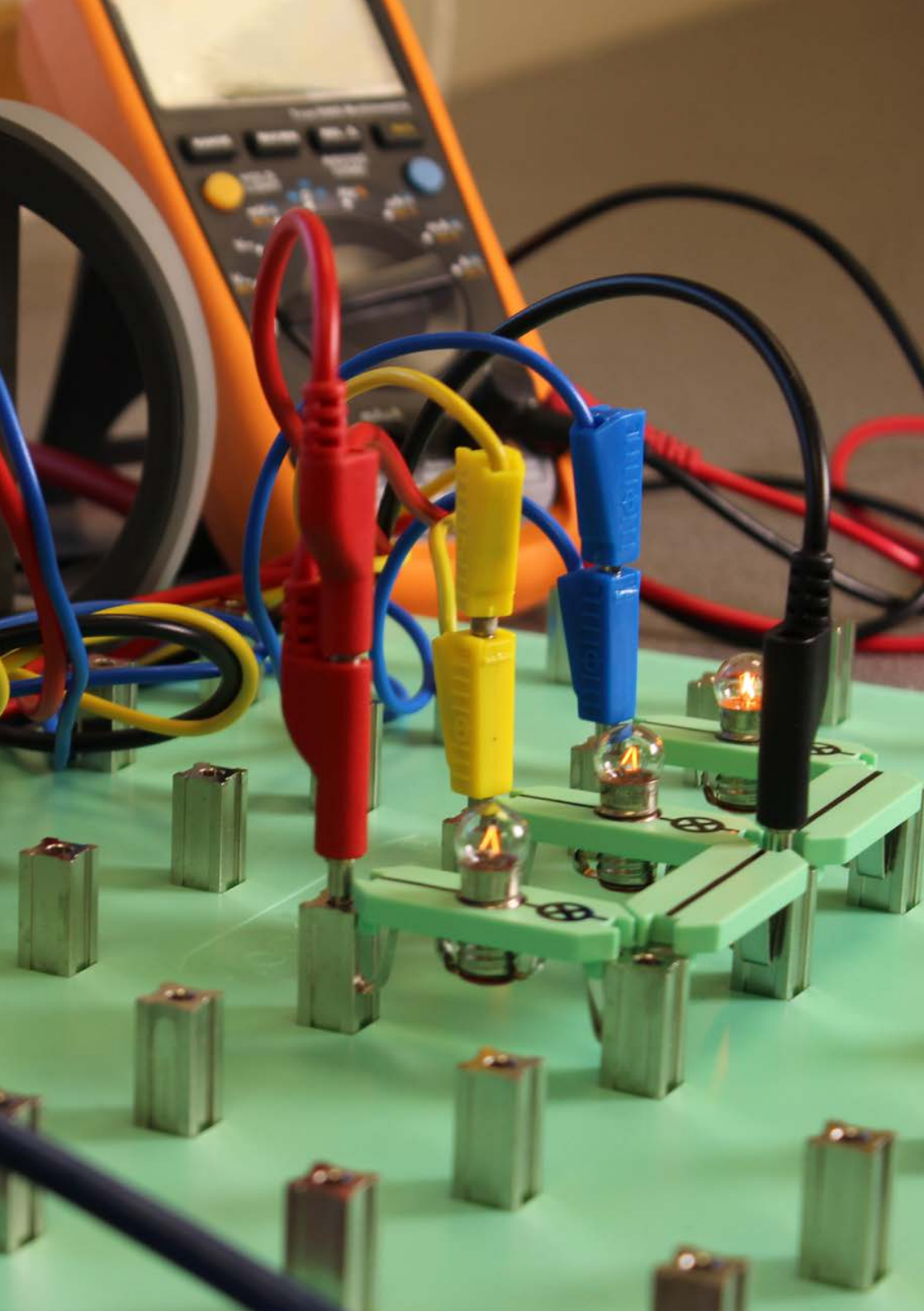

# Mechanical and Electrical Conversion



Course Name	Code	Length	Price Exc. VAT
Electrical to Mechanical Conversion	EMC	5 Day	£1,210
Mechanical to Electrical Conversion	MEC	5 Day	£1,210

Training available in York, Slough, Livingston and On-site



**"Excellent course and venue."**

"Excellent course and venue. Looking forward to going back for my next one. Course tutor was very knowledgeable and kept it interesting."

Andrew - York Teaching Hospitals Facilities Management

City & Guilds Accredited  
Electrical to Mechanical  
Conversion

## Electrical to Mechanical Conversion

📍 York, Slough and Livingston | 5 Day | £1,210

### Course Overview:

This City & Guilds accredited course will enable you to gain a basic knowledge of mechanical principles and concepts, as well as an understanding of mechanical plant operation and isolation requirements of plant and pressure systems.

### Who Is This Course For:

This course is aimed at staff working within a Mechanical & Electrical environment who would benefit from increased awareness of mechanical principles and practices as part of their current role. It also provides a foundation course for those likely to undertake other mechanical courses.

### Key Learning Areas Covered In This Course:

- Key aspects of UK legislation
- Fundamental mechanical principles, including heat transfer, fuels and combustion
- Pumps, systems and components including valve types and heat exchangers
- Refrigeration and air conditioning systems
- Pressure plant including steam
- Hot water plant and water treatment
- Compressed air plant and hydraulic systems
- Plant operating procedures – start up and shut down
- Fire protection and shutdown systems associated with mechanical installations
- Maintenance strategies and procedures



## Mechanical to Electrical Conversion

📍 York, Slough, Livingston and On-site | 5 Day | **£1,210**

### Course Overview:

This City & Guilds accredited course has been developed to provide delegates with a basic knowledge of electrical theory as well as an understanding of electrical machine principles and isolation requirements of electrical plant for mechanical work.

### Who Is This Course For:

This course is aimed at those working within a mechanical and electrical environment who would benefit from increased awareness of electrical principles and practices as part of their current role. It is also a good foundation course for those likely to undertake other electrical courses.

### Key Learning Areas Covered In This Course:

- Requirements of the Electricity at Work Regulations and dangers of electricity
- Electrical safe systems of work including practical isolation exercises
- Electrical circuit theory and practical use of measuring instruments
- Low Voltage protection devices
- Requirements of BS7671:2018 (2022)
- Single and three phase motors and associated starters
- Inverter drives
- Connection and verification of electric motor wiring
- Motor fault finding
- Final assessment exercise



# Confined Spaces and Working At Height



Course Name	Code	Length	Price Exc. VAT
Authorised Person Confined Spaces (Commercial)	APCS	4 Day	£1,195
Competent Person Confined Spaces	CPCS	2 Day	£525
Authorised Person Confined Spaces Refresher	APCSR	3 Day	£895
Competent Person Confined Spaces Refresher	CPCSR	1 Day	£285
Authorised Person Working At Height (Commercial)	APWHC	3 Day	£895

Training available in York, Slough, Livingston and On-site



★★★★★

"A very good experience that will make me better in my role."

"Excellent, this was a very good experience, excellent tutor good venue amazing atmosphere, all course content very relevant, i would recommend this course to anybody"

Paul - Department of Justice

City & Guilds Accredited  
Authorised Person Confined  
Spaces (Commercial)

## Authorised Person Confined Spaces (Commercial)

📍 York, Slough and On-site | 4 Day | **£1,195**

### Course Overview:

This City & Guilds accredited course has been developed to follow the advice outlined in the Safe Work in Confined Spaces, Confined Spaces Regulations 1997, Approved Code of Practice, Regulations and Guidance L101, JSP375, Volume 3 Chapter 6 and Procedures for Confined Spaces.

This course does not satisfy the requirements for confined space working within sites controlled by the MOD, please refer to Authorised Person Confined Spaces (MOD) (CSMOD)

### Who Is This Course For:

This is aimed at those who have been selected for training to become an Authorised Person (Confined Spaces) with responsibilities to implement, manage and control all aspects of confined space operations ensuring that a safe system of work is in place prior to any confined space activities being permitted.

### Key Learning Areas Covered In This Course:

- The current Health & Safety legislation in respect to confined spaces
- Gain an understanding of safe systems of work and complete safety documentation including Permits to Work
- Understand the minimum safety equipment requirements and procedures utilised for safe entry and egress
- Have an awareness for the responsibilities for individuals within the work team, training and fitness requirements
- Understand the actions and reporting procedures needed in respect to response to emergencies
- You will carry out a practical entry into confined spaces using escape breathing apparatus (EBA)

## Competent Person Confined Spaces

📍 York, Slough and On-site | 2 Day | £525

### Course Overview:

This Competent Person Confined Spaces training course is designed to meet the essential requirements of safe working in confined spaces required by the Confined Spaces Regulations 1997. Approved Code of Practice, Regulations and Guidance (L101) JSP375, Volume 3, Chapter 6 and Procedures for Confined Spaces.

### Who Is This Course For:

Primarily this is aimed at operatives who require training for entry into Medium Risk Confined Spaces where the use of continuous gas monitoring and Escape Breathing Apparatus (EBA) is required as part of a control measure based on a risk assessment. The confined space will have been assessed as safe to enter, and to work in, but atmospheric conditions may change due to the nature of the space or work being carried out. There is a requirement to appoint a person in charge and have specific emergency arrangements in place.

### Key Learning Areas Covered In This Course:

- Health and safety legislation
- Identifying and classifying confined spaces
- Hazards and risks associated with confined space working
- Problem atmospheres (gases and gas monitoring)
- Work team roles and duties. First aid, medical and training requirements
- Introduction to Confined Space equipment and escape breathing apparatus (EBA)
- Use of Confined Space equipment and practical entry and exit with EBA
- A self-certification fitness questionnaire is to be completed

## Authorised Person Confined Spaces Refresher

📍 York, Slough and On-site | 3 Day | £895

### Course Overview:

Where applicable this course follows the advice given in the Safe Work in Confined Spaces; Confined Spaces Regulations 1997, Approved Code of Practice, Regulations and Guidance L101, JSP375 Volume 3 Chapter 6 and Procedures for Confined Spaces.

### Who Is This Course For:

This course is aimed at those who have previously been trained and appointed as an Authorised Person (Confined Spaces) and has or currently has responsibilities to implement, manage and control all aspects of confined space operations, ensuring that a safe system of work is in place prior to any confined space.

### Key Learning Areas Covered In This Course:

- The current health and safety legislation in respect to confined spaces
- Hazards and risks associated with confined spaces and implementation of appropriate control measures
- Categories of confined spaces, records and registers
- Safe systems of work associated with confined space entry and complete safety documentation including Permits to Work
- The minimum safety equipment requirements and procedures to be utilised for safe entry and egress
- The responsibilities for individuals within the work team, training and fitness requirements
- Activities are permitted



## Competent Person Confined Spaces Refresher

📍 York, Slough, Livingston and On-site | 1 Day | £285

### Course Overview:

This Competent Person Confined Spaces Refresher course involves the presence of one or more people, positioned outside the confined space, who have designated responsibilities for controlling the entry into the confined space. The practical element of this course may involve vertical entry using a ladder and fall arrest/recovery winch or man-riding winch. It can also involve horizontal entry, such as walking or climbing into the confined space or working away from the bottom of a vertical entry, with limited use of a rescue line.

### Who Is This Course For:

The course is aimed at operatives who may need to carry out competent person confined space refresher training. This requires the use of gas monitoring and may require the carrying of escape breathing apparatus (ie. foul and storm water sewerage systems). On completion of the course, delegates should be able to continue to operate in medium risk confined spaces, understand the risks that may be present or introduced and ensure that appropriate control measures are in place prior to entry.

### Key Learning Areas Covered In This Course:

- Overview of Health & Safety and the Confined Spaces Regulations
- Reminder of "What is a Confined Space?"
- Hazards associated with confined spaces
- Problem atmospheres (gases & gas monitoring)
- Safe systems of work
- Work team roles and duties
- First aid and medical considerations
- Typical confined space equipment and user checks
- User checks and assembly of Escape Breathing Apparatus (EBA)
- Practical entry exercise with gas monitor, harness, tripod and winch and EBA





# Authorised Person Working At Height (Commercial)

📍 York, Slough, Livingston and On-site | 3 Day | £895

APW/HC

## Course Overview:

This City & Guilds accredited course will provide you with the requisite knowledge to be able to identify and advise on typical working at height activities, and the associated risks. You will also be able to check the competency of operatives, the quality of their equipment, and ensure that the correct control measures and safety documentation is in place prior to issuing a permit for work to be carried out.

## Who Is This Course For:

This course has been developed to provide maximum support for those who have been put forward for Authorised person positions with responsibility to implement, manage and control all aspects of Working at Height operations at site level, ensuring that a safe system of work is in place.

## Key Learning Areas Covered In This Course:

- Overview of Health and Safety and statutory regulations
- Management Arrangements (Hierarchy of Control Measures)
- Roles and duties
- Assessment, appointment, auditing and monitoring
- Climbing teams and authorised climbers
- Personal protective equipment and respiratory protective equipment
- Operating procedures (safety documentation)
- Rooftop working (HSG33)
- Safety Documentation worked examples and scenario



# Mechanical and Pressure Systems



Course Name	Code	Length	Price Exc. VAT
Authorised Person Mechanical and Pressure Systems	APMPS	4 Day	£1,195
Skilled Person Mechanical and Pressure Systems	SPMPS	2 Day	£525

Training available in York, Slough, Livingston and On-site



★★★★★

**"Perfect venue for training and development."**

"Parking, Venue, tutor (Carl Davies) and rest of the building facilities was excellent as always been. This wasn't my first time at PPL Slough but always the first choice for training, definitely recommended for quality training and great learning atmosphere."

Ilhan - ISS

City & Guilds Accredited  
Authorised Person  
Mechanical and  
Pressure Systems



## Authorised Person Mechanical and Pressure Systems

📍 York, Slough, Livingston and On-site | 4 Day | **£1,195**

### Course Overview:

Many organisations have adopted JSP 375 Volume 3 Chapter 4 (or parts thereof) as the basis for a Safe System of Work as applied to mechanical systems. For practicable commonality this course is based on the content of this document together with HSG 253 Safe Isolation of Equipment.

### Who Is This Course For:

This City & Guilds accredited course is aimed at experienced engineering staff with the responsibility for the implementation of risk management systems and procedures as part of, and in accordance with, their Organisation - Safety Policy. This course has been designed for those with the responsibility for the control, operation and maintenance of an installed mechanical plant and who may be appointed as Authorised Person Mechanical or Pressure Systems. It is also suitable for those with overseeing and audit responsibilities.

### Key Learning Areas Covered In This Course:

- Fundamental principles of applied mechanics and thermodynamics
- Mechanical systems and components
- Requirements of pressure systems safety regulations
- Requirements of HASAWA 1974 and delegated legislation
- Safe systems of work associated with mechanical systems
- Functional risk assessments
- Monitoring and audit requirements
- Practical exercises in the completion of safety documentation

# Skilled Person Mechanical and Pressure Systems

📍 York, Slough, Livingston and On-site | 2 Day | £525

SPMPS

## Course Overview:

This City & Guilds accredited course will enable you to gain the knowledge required to carry out the role of Competent or Skilled Person (Mechanical) and can assist in demonstrating a full understanding of company safety rules and procedures during formal assessment. Many organisations have adopted JSP 375 Volume 3 Chapter 4 (or parts thereof) as the basis for a Safe System of Work as applied to mechanical systems. For practicable commonality this course is based on the content of this document together with HSG 253 Safe Isolation of Equipment. This course is NOT suitable for those persons intending to carry out examinations and inspections in accordance with regulations 8,9 & 10 (written scheme of examination) of the Pressure Systems Safety Regulations (PSSR) 2000

## Who Is This Course For:

This is aimed at mechanical staff with responsibility for the operation or maintenance of installed mechanical plant and who may be nominated as a Competent or Skilled Person within their organisation.

## Key Learning Areas Covered In This Course:

- Technical overview of mechanical systems components
- Requirements of Pressure Systems Safety Regulations
- Safe system of work associated with mechanical systems
- Receipt of safety documentation



# Fire Safety



Course Name	Code	Length	Price Exc. VAT
Fire Safety Responsible Person Introduction	FSRPI	1 Day	£280
Fire Door Survey and Inspection	FDSI	1 Day	£280
Fire and Smoke Damper Survey and Inspection	FSDSI	1 Day	£280
Fire Stopping Survey and Inspection	FSSI	1 Day	£280
Fire Safety Technical Awareness	FSTA	3 Day	£855
Escape Lighting	ESL	2 Day	£445
Fire Alarms and Detection Systems - Commercial	BS5839-1	1 Day	£280

Training available in York, Slough, Livingston and On-site



"Useful training well delivered"

"Great training provider and facilities"

John - University of York

City & Guilds Accredited  
Fire Safety Stopping Survey  
and Inspection

# Our Facilities

## Fire Safety Practical Training



### The Importance of Practical Training

Our brand new practical facilities showcase industry standard installations of fire and smoke dampers, fire stopping measures, fire doors, escape lighting and more. It is paramount that we continue to provide the most up-to-date practical demonstrations, ensuring that delegates can immerse themselves in our real-world installations, improving the delegate experience, and ultimately, increasing competency.



1

## Fire Safety Corridor

Designed to mimic the variety of corridors present in many commercial settings, NHS, Office and Industrial environments, etc, delegates will find a wide range of fire precautions for surveying, inspecting and testing in a practical setting.

Installations include:

- Fire Alarms and Detection Systems
- Fire and Smoke Dampers
- Fire Stopping
- Fire Doors (including Anti-Barricade Doors)
- Adaptive Lighting
- Emergency Lighting
- Battery Powered Escape Lighting
- Automated Fire Curtain

2

## Fire and Smoke Damper and Fire Stopping Demonstration Area

For use as a practical teaching aid in our Survey and Inspection courses, this area houses the following:

- Motorised Dampers
- Mechanical Curtain Dampers with Fusible Link
- Mechanical Butterfly Damper with Fusible Link and External Reset
- Various Fire Stopping examples; Copper Pipes, Plastic Pipes (PP, PVC and PE), Cables and Cable Trays

3

## Fire Doors and Fire and Smoke Damper Area

Where delegates may require closer inspection of equipment to gain a greater understanding of the mechanisms and structural make up of certain fire safety precautions, our facility showcases:

- Fire Door cross-sections
- Access Hatch examples
- Ironmongery and Intumescent Strips
- Large Mechanical Curtain Dampers
- Floor Mounted Dampers

**"Excellent and much needed programme. Fire doors, fire stopping and fire dampers are a crucial and complex discipline in which there is no grey area between right and wrong. The fire safety industry is historically plagued with a lack of understanding and we welcome this course to develop understanding within both the applicator and end user market."**

Saracen Compliance Services LTD

# DCLG Guidance for Your Premises

## Find a Course That Suits You

### Fire Risk Assessment Guidance

The Department for Communities and Local Government (DCLG) offers guidance for employers, managers, occupiers and owners concerned with various types of premises.

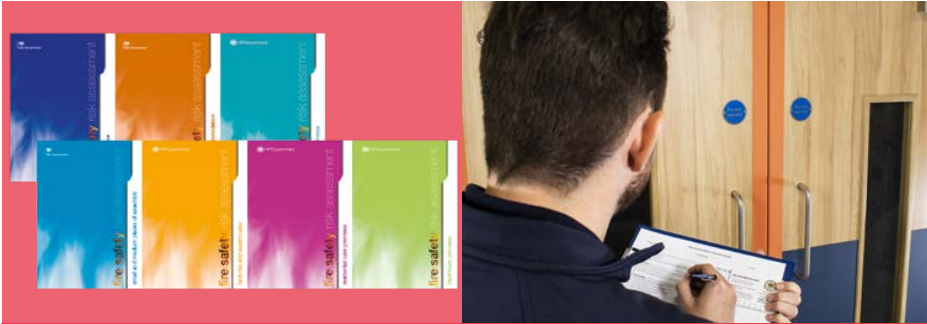

### Finding a Course To Suit Your Premises

Your Premises	Our Suggested Fire Safety Course(s)
Offices and Shops	<ul style="list-style-type: none"> <li>• Fire Safety Responsible Person Introduction</li> <li>• Fire Door Survey and Inspection</li> <li>• Fire Alarms and Detection Systems (Commercial)</li> </ul>
Sleeping Accommodation	<ul style="list-style-type: none"> <li>• Fire Safety Responsible Person Introduction</li> <li>• Fire Door Survey and Inspection</li> <li>• Fire Alarms and Detection Systems (Commercial)</li> <li>• Fire Stopping Survey and Inspection</li> <li>• Escape Lighting</li> </ul>
Educational Premises	<ul style="list-style-type: none"> <li>• Fire Safety Responsible Person Introduction</li> <li>• Fire Door Survey and Inspection</li> <li>• Fire Alarms and Detection Systems (Commercial)</li> </ul>
Places of Assembly	<ul style="list-style-type: none"> <li>• Fire Safety Responsible Person Introduction</li> <li>• Fire Door Survey and Inspection</li> <li>• Fire Alarms and Detection Systems (Commercial)</li> <li>• Escape Lighting</li> </ul>



Factories and Warehouses	<ul style="list-style-type: none"> <li>• Fire Safety Responsible Person Introduction</li> <li>• Fire Alarms and Detection Systems (Commercial)</li> <li>• Escape Lighting</li> </ul>
Residential Care Premises	<ul style="list-style-type: none"> <li>• Fire Safety Responsible Person Introduction</li> <li>• Fire Safety Responsible Person Introduction – Healthcare Premises</li> <li>• Fire Door Survey and Inspection</li> <li>• Fire Stopping Survey and Inspection</li> <li>• Fire Alarms and Detection Systems (Commercial)</li> <li>• Escape Lighting</li> </ul>
Healthcare Premises	<ul style="list-style-type: none"> <li>• Fire Safety Responsible Person Introduction</li> <li>• Fire Safety Responsible Person Introduction – Healthcare Premises</li> <li>• Fire and Smoke Damper Survey and Inspection</li> <li>• Fire Door Survey and Inspection</li> <li>• Fire Stopping Survey and Inspection</li> <li>• Fire Alarms and Detection Systems (Commercial)</li> <li>• Escape Lighting</li> </ul>



## Fire Safety Responsible Person Introduction

📍 York, Slough and Livingston | 1 Day | £280

### Course Overview:

This City & Guilds accredited course provides you with the basic understanding of what is required to manage fire safety, as a responsible person, to enable compliance under the Regulatory Reform (Fire Safety) Order 2005 and the Health and Safety at Work Act. Upon completion, you will be issued with a City & Guilds accredited certificate of achievement.

### Who Is This Course For:

This course has been designed for estates officers, and any other personnel who have a responsibility in terms of fire safety, who require a detailed level of understanding to ensure you have the competence to manage fire safety within your premises.

### Key Learning Areas Covered In This Course:

- Understanding fire safety legislation and the requirements of the RRO 2005
- Identifying fire hazards and their control through routine inspections and assessments
- Identify any fire safety management deficiencies
- Review of fire risk assessments
- Maintenance of fire safety records and documentation
- Management and maintenance of fire emergency plans

# Fire Safety Technical Awareness

📍 York and Slough | 3 Day | £855

## Course Overview:

This City & Guilds accredited course incorporates the latest legislation, guidance and manufacturers standards, along with hands on practical experience to enhance the technical understanding of nominated fire safety personnel within the healthcare/ estates environment. The course focuses on specific hardware associated with passive fire safety including fire dampers and fire doors. Active fire safety measures such as fire alarms and emergency lighting will also be covered within this course. Upon completion, you will be issued with a City & Guilds accredited certificate of achievement.

## Who Is This Course For:

This course has been designed for healthcare/estates fire safety personnel, where the delegate will gain sufficient knowledge to understand the practical elements that may be detailed within a trust fire risk assessment, and experience examples of good and bad within the respective subject matter.

## Key Learning Areas Covered In This Course:

- Introduction to the associated legislation, industry guidance & specifications in relation to fire safety
- A general understanding of the requirements for; fire dampers and their testing requirements, fire doors and basic fault identification, fire stopping and compartmentation, along with basic survey, fire alarm systems and their testing requirements, and emergency lighting, including its role in horizontal evacuation
- Practical examples of the different types of equipment/systems used in passive fire safety, along with undertaking functional tests/surveys to increase overall understanding
- The maintenance requirements of NHS HTM 05-02: Guidance in support of functional provisions for healthcare premises
- The importance of a robust management system and record keeping



## Fire Door Survey and Inspection

FDSI

📍 York and Slough | 1 Day | £280

### Course Overview:

This City & Guilds accredited course incorporates the latest legislation, guidance and manufacturers standards to enable the surveying and routine testing of dampers within the healthcare environment. The course includes practical examples of what to expect with the typical fire & smoke damper installation in a variety of areas. Together the theory and practical elements will assist in compliance with the Regulatory Reform (Fire Safety) Order, HTM 05-02, BS9999 and site fire safety maintenance requirements. Upon completion, you will be issued with a City & Guilds accredited certificate of achievement.

### Who Is This Course For:

This course has been designed for healthcare/estates engineers and other personnel. The delegate will gain sufficient knowledge and information to conduct duties required by the RRO and within BS9999 and HTM 05-02, including the production of the associated inspection and test report. This will help in achieving compliance with all regulatory requirements and with following best practice in line with guidance documents.

### Key Learning Areas Covered In This Course:

- Introduction to the associated legislation, industry guidance & specifications in relation to ventilation system fire safety
- A general understanding of the requirements of BESA guidance documents DW 144/145, TRI9 and DW172
- A general understanding of BS EN 9999 Code of practice for fire safety in the design, management and use of buildings
- The maintenance requirements of NHS HTM 05-02: Guidance in support of functional provisions for healthcare premises
- Installation requirements of fire and smoke dampers
- Identify defects in fire compartmentation associated with incorrect damper installation
- Test fire and smoke dampers to correct requirements within their respective environments

## Fire and Smoke Damper Survey and Inspection

📍 York and Slough | 1 Day | £280

FSDSI

### Course Overview:

This City & Guilds accredited course incorporates the latest legislation, guidance and manufacturers standards to enable the surveying and routine testing of dampers within the healthcare environment. The course includes practical examples of what to expect with the typical fire & smoke damper installation in a variety of areas. Together the theory and practical elements will assist in compliance with the Regulatory Reform (Fire Safety) Order, HTM 05-02, BS9999 and site fire safety maintenance requirements. Upon completion, you will be issued with a City & Guilds accredited certificate of achievement.

### Who Is This Course For:

This course has been designed for healthcare/estates engineers and other personnel. The delegate will gain sufficient knowledge and information to conduct duties required by the RRO and within BS9999 and HTM 05-02, including the production of the associated inspection and test report. This will help in achieving compliance with all regulatory requirements and with following best practice in line with guidance documents.

### Key Learning Areas Covered In This Course:

- Introduction to the associated legislation, industry guidance & specifications in relation to ventilation system fire safety
- A general understanding of the requirements of BESA guidance documents DW 144/145, TRI9 and DW172
- A general understanding of BS EN 9999 Code of practice for fire safety in the design, management and use of buildings
- The maintenance requirements of NHS HTM 05-02: Guidance in support of functional provisions for healthcare premises
- Installation requirements of fire and smoke dampers
- Identify defects in fire compartmentation associated with incorrect damper installation
- Test fire and smoke dampers to correct requirements within their respective environments

## Fire Stopping Survey and Inspection

📍 York and Slough | 1 Day | £280

### Course Overview:

This City & Guilds accredited course intends to 'up-skill' those working with the fabric of the building. This will give knowledge and understanding in relation to the checking of fire stopping and compartmentation arrangements with respect of fire safety. This is in accordance with the requirements of the Regulatory Reform (Fire Safety) Order, HTM 05-02/3 and the respective fire safety protocol. Upon completion, you will be issued with a City & Guilds accredited certificate of achievement.

### Who Is This Course For:

This course has been designed for healthcare/estates engineers and other personnel. The delegate will gain sufficient knowledge to ensure compartmentation and structural fire safety is not compromised during and after work has been carried out, therefore maintaining compliance with all regulatory and guidance requirements.

### Key Learning Areas Covered In This Course:

- Legal requirements for fire stopping and compartmentation
- Identify how fire compartmentation is established within buildings
- Installation requirements of penetration sealing systems
- Typical types of penetration and their respective fire stopping arrangements
- Fire stopping performance and typical defects
- Typical installation and maintenance requirements of fire stopping systems.
- Cavity barriers, fire curtains and smoke barriers



# Escape Lighting

📍 York, Slough and On-site | 2 Day | **£445**

## Course Overview:

This City & Guilds accredited course has been developed to assist delegates in gaining the knowledge required to carry-out design of emergency lighting systems to comply with BS5266. The training also covers the certification requirements, and the maintenance of emergency lighting systems in accordance with BS5266.

## Who Is This Course For:

This Escape Lighting training course is aimed at electrical staff who have responsibility for carrying out planned maintenance of emergency lighting installations at their place of work.

## Key Learning Areas Covered In This Course:

- Introduction to types of emergency lighting and requirements of BS5266
- Design of emergency lighting systems
- Risk assessment
- Commissioning requirements and measurement of performance
- Battery types and charging systems
- Maintenance and testing of installations in accordance with British standards
- Installation and certification
- Practical design exercise and measurement of lighting levels



# Fire Alarms and Detection Systems - Commercial

📍 York, Slough and On-site | 1 Day | £280

BS5839-1

## Course Overview:

The course is written to provide a basic knowledge and understanding of the major parts of BS5839 Part 1, covering the requirements for fire alarm and detection systems in commercial installations.

## Who Is This Course For:

The course is designed for any electrician who has a responsibility for installation or maintenance of Commercial Fire Alarm and Detection Systems and provides an in-depth introduction. The course concludes with a written examination.

## Key Learning Areas Covered In This Course:

- The legal requirements for fire alarm and detection systems
- The necessity for a Fire Risk Assessment.
- Basic design requirements for a fire alarm and detection System, detailing grades and categories
- Components and equipment options, necessary for a fire alarm and detection system
- Installation requirements for components and equipment
- Cross-over between BS5839 Part 1 and Part 6
- Necessary testing, maintenance and reporting procedures

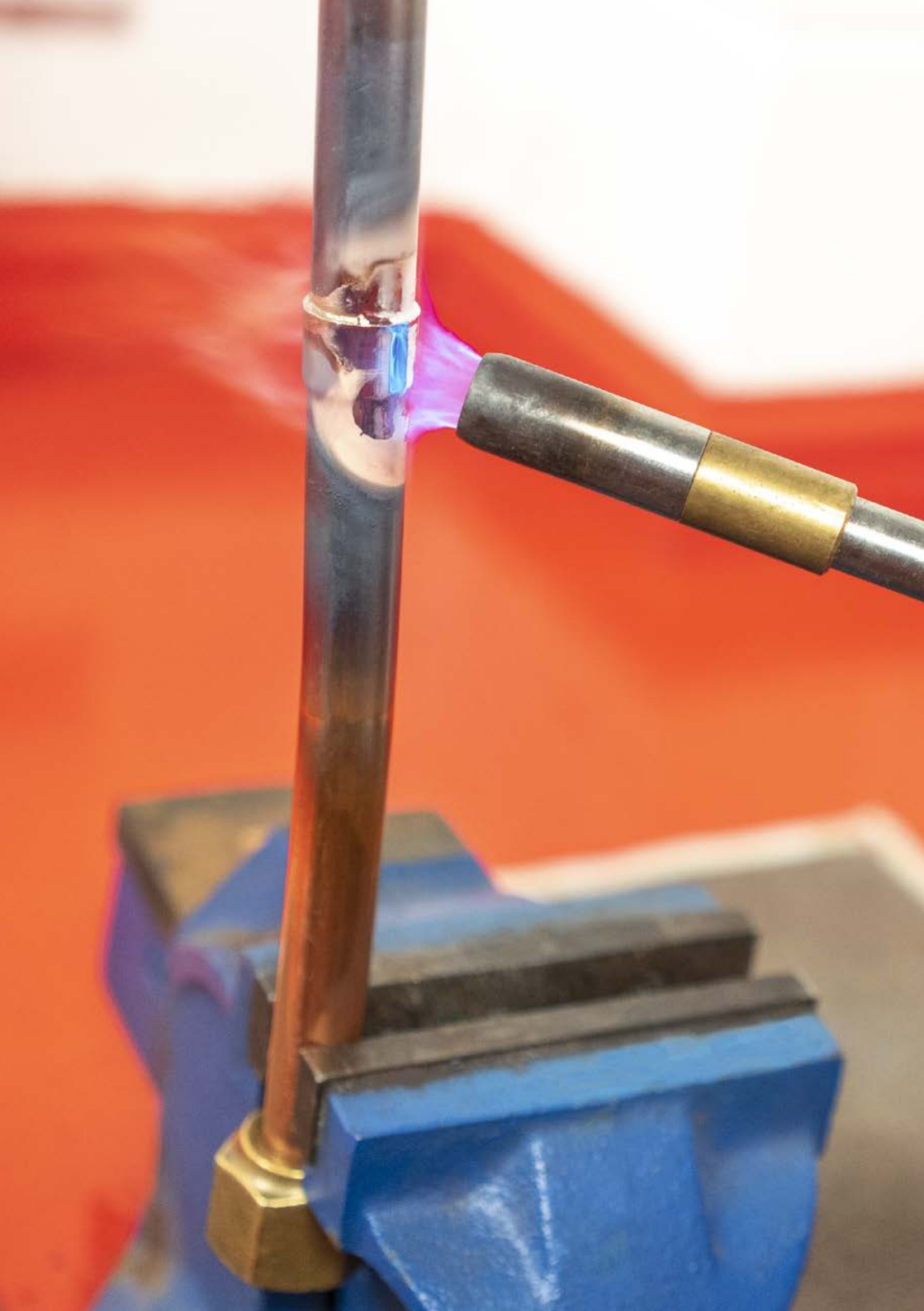

# F-Gas Handling



Course Name	Code	Length	Price Exc. VAT
F-Gas (Category 1)   City & Guilds 2079-11	FCAT1	5 Day	£975
F-Gas (Category 2)   City & Guilds 2079-12	FCAT2	5 Day	Price on Request
F-Gas (Category 3)   City & Guilds 2079-13	FCAT3	2 Day	Price on Request
F-Gas (Category 4)   City & Guilds 2079-14	FCAT4	2 Day	£495
Hydrocarbon Qualification   City & Guilds 6187-21	6187	1 Day	£325
F-Gas Compliance	FGCOM	2 Day	£525
Introduction to Air Conditioning	IAC	3 Day	£800

Training available in York, Slough, Livingston and On-site



## F-Gas (Category 1) | City & Guilds 2079-11

📍 York, Slough and Livingston | 5 Day | **£975**

### Course Overview:

This City & Guilds course will provide you with the knowledge and practical skills required to work on the installation, service, maintenance, recovery and leakage checking of stationary refrigeration, air conditioning and heat pump equipment with a charge more than 3kg or 6kg (if hermetically sealed).

### Who Is This Course For:

This is aimed at those working within the refrigeration and air-conditioning industry who need to meet the legal requirements for working with fluorinated gases, and other ozone depleting substances.

### Key Learning Areas Covered In This Course:

- Basic systems, principles and units and how they relate to theory and thermodynamics of vapour compression cycles and refrigerants
- Causes and effects of global warming and ozone depletion
- Identification of air conditioning and heat pump components, functions and leakage risk
- Hazards and safe working practices
- Construction and examination of pipe work
- Recovery of refrigerant and oil and prepare for disposal
- Pressure testing, evacuation and record completion
- Refrigerant charging, leak checking and record keeping
- Fabrication and fitting of mechanical and brazed joints

## F-Gas (Category 2) | City & Guilds 2079-12

 York and Slough | 5 Day | **Price on Request**

### Course Overview:

This City & Guilds course will provide you with the knowledge and practical skills to work on the installation, service, maintenance and leakage checking of stationary refrigeration, air conditioning and heat pump equipment with a charge of less than 3kg (6kg if hermetically sealed).

### Who Is This Course For:

This is aimed at those working within the refrigeration and air-conditioning industry who need to meet the legal requirements for working with fluorinated gases, and other ozone depleting substances.

### Key Learning Areas Covered In This Course:

- Basic systems, principles and units and how they relate to theory and thermodynamics of vapour compression cycles and refrigerants
- Causes and effects of global warming and ozone depletion
- Identification of air conditioning and heat pump components, functions and leakage risk
- Hazards and safe working practices
- Construction and examination of pipe work
- Recovery of refrigerant and oil and prepare for disposal
- Pressure testing, evacuation and record completion
- Refrigerant charging, leak checking and record keeping
- Fabrication and fitting of mechanical and brazed joints

## F-Gas (Category 3) | City & Guilds 2079-13

📍 York and Slough | 2 Day | **Price on Request**

### Course Overview:

This City & Guilds course will provide you with the knowledge and practical skills to undertake refrigerant recovery from stationary refrigeration, air conditioning and heat pump equipment to meet Category III theoretical and practical requirements.

### Who Is This Course For:

This course is designed for those working within the refrigeration and air-conditioning industry who need to meet the legal requirements for working with fluorinated gases, and other ozone depleting substances.

### Key Learning Areas Covered In This Course:

- Cause and effects of ozone depletion
- Cause and effects of global warming and climate change
- Hazards and safe working practices for the recovery, storage and transportation of recovered refrigerants
- Recovery of refrigerant and oil and preparation for disposal



## F-Gas (Category 4) | City & Guilds 2079-14

 York, Slough and Livingston | 2 Day | **£495**

### Course Overview:

This City & Guilds course will provide you with the knowledge and practical skills to undertake leak checking of stationary refrigeration, air conditioning and heat pump equipment to meet category IV theoretical requirements.

### Who Is This Course For:

This is aimed at those working within the refrigeration, air-conditioning and heat pump sector using fluorinated gases and ozone depleting substances.

### Key Learning Areas Covered In This Course:

- Basic standard units and thermodynamics principles of vapour compression cycle
- Cause and effects of global warming and climate change
- Identification of air conditioning and heat pump components, functions and leakage risk
- Hazards and safe working practices for leak checking of stationary refrigerant, air conditioning and heat pump systems
- Cause and effect of ozone depletion
- Undertake leak checking and record keeping

## Hydrocarbon Qualification | City & Guilds 6187-21

📍 York, Slough, Livingston and On-site | 1 Day | £325

### Course Overview:

This City & Guilds course will provide you with the skills and knowledge to safely handle hydrocarbon refrigerants during installation, service, maintenance and disposal. This course covers all Hydrocarbon refrigerants, including R290 and R600a. It is also suitable for engineers working with flammable HFOs and HFCs including R1234yf, R1234ze and R32.

### Who Is This Course For:

This is aimed at experienced engineers who work on systems containing hydrocarbon and flammable refrigerants. To enrol on this course you must be experienced in working with refrigeration and air-conditioning systems and must hold the C&G 2079-11, 2079-12 or equivalent qualification.

### Key Learning Areas Covered In This Course:

- Dangers of working with hydrocarbons and identifying hazards
- Regulations for the installation, servicing and de-commissioning of hydrocarbon RAC systems
- Hazards and safe working practices for the recovery, storage and transportation of recovered refrigerants
- Recovery of refrigerant and oil and preparation for disposal



## F-Gas Compliance

📍 York, Slough, Livingston and On-site | 2 Day | £525

### Course Overview:

This City & Guilds accredited course will enable you to understand your obligations within the F-gas regulations 2014. It will also allow you to oversee work carried out by engineers and contractors whilst maintaining the required documentation..

### Who Is This Course For:

This course is aimed at those involved with management of Refrigeration and Air Conditioning Systems containing Ozone Depleting Substances or F-gases and the associated statutory and mandatory legislation and documentation.

### Key Learning Areas Covered In This Course:

- The Basic Physics of Air Conditioning and Refrigeration
- SI Units Pressure Temperature
- Principles of Air Conditioning and Refrigeration Systems
- Introduction to the refrigeration Cycle
- Components
- Compressor Condenser
- Expansion Devices Evaporators
- Environmental Issues
- Refrigerant types Hazards
- Protocols Legislation
- Records and Documents
- F-Gas register
- Log Book
- Waste Transfer Environment Agency

# Introduction to Air Conditioning

 York and Slough | 3 Day | £800

## Course Overview:

This City & Guilds accredited course will provide an understanding of Air Conditioning Systems and the processes involved. It will also promote the knowledge required to carry out or manage work on the various systems encountered.

## Who Is This Course For:

This is aimed at staff who are involved with working on or overseeing work on Air Conditioning Systems; enabling delegates to not only understand the theory and safety related aspects, but also to be able to do the job.

## Key Learning Areas Covered In This Course:

- Introduction to basic mechanical and thermodynamic physics
- Introduction to psychrometry and use of psychrometric charts
- Air conditioning system components
- Principles of air conditioning
- Associated regulations
- Types and practical use of measuring instruments
- Balancing of air conditioning distribution systems

# York Campus

We also offer bespoke training solutions to suit your needs. These solutions can have their own benefits to you and your team:

**View on Google Maps or What3Words:**

PPL House, 6 Opus Avenue, York YO26 6BL  
[///gear.ripe.net](https://www.gear.ripe.net)

Unit 4, Tudor Court, York YO26 6RS  
[///slim.even.stuck](https://www.slim.even.stuck.com)



## Our Facilities

York has been our home at PPL Training since the company's inception. Growing from a 400ft<sup>2</sup> warehouse unit on James Street in York to what is now an enterprise spanning 3 locations and with over 50,000ft<sup>2</sup> of training facilities.



In 2013 the company moved to York Business Park as we solidified our focus on Mechanical and Electrical training, curating training facilities to suit our ever-expanding curriculum of courses.

In 2019 We acquired Tudor Court, just over the road from the bulk of our centres on Opus Avenue, and in 2021 we received the keys to Unit 8. Find out what each individual centre plays host to below:

### Classrooms

### Practical Facilities

#### Unit 5

- Dirac
- Edison
- Davy
- Mechanical and Pressure Systems
- Mechanical and Electrical Conversion
- F-Gas Handling
- Medical Gas Pipeline Systems
- Ventilation



### Unit 6

- Dyson
- Stephenson
- Faraday
- High Voltage Ring 1
- Low Voltage
- Airfield Lighting
- Confined Spaces (outside at rear)

### Unit 8

- Hertz
- Watt
- Connelly
- Hawksley Exam Suite
- Fire Safety
- High Voltage Ring 2
- Hazardous Areas
- Petroleum
- Low Voltage



### Unit 4 - Tudor Court

- Joule
- Franklin
- Fleming
- Electrical Installations
- Legionella (Water Hygiene)

# 📍 Slough Campus

We also offer bespoke training solutions to suit your needs. These solutions can have their own benefits to you and your team:



Malton Ave

468 Malton Avenue, Slough SL1 4QU

///audit.supply.master



Bedford Ave

108 Bedford Avenue, Slough SL1 4RA

///metal.stress.lasts



Buckingham

103 Buckingham Ave, Slough SL1 4PF

///foods.sunk.focal

## Our Facilities

In 2015, as part of a planned expansion, we opened our flagship centre in the south, 468 Malton Avenue. Affectionately known as PPL House, this centre formed the base for what we now have, a campus of 3 buildings, spanning the Slough Trading Estate.

Now with 108 Bedford Avenue and 103 Buckingham Avenue now online, we have been able to replicate the practical training facilities that we have in York, covering all disciplines within our portfolio of training courses:

### Classrooms

### Practical Facilities

#### 468 Malton Avenue

- Swan
- Cayley
- Bell
- Maxwell
- Brunel
- Newton
- High Voltage
- Low Voltage
- Ventilation
- Medical Gas Pipeline Systems
- Airfield Lighting
- Hazardous Areas
- Confined Spaces
- Petroleum







### 108 Bedford Avenue

- Babbage
- Snow
- Harrison
- Electrical Installations
- Legionella (Water Hygiene)

### 103 Buckingham Avenue

- Carrier
- Law
- Smith
- Shilling
- Fire Safety
- Mechanical and Pressure Systems
- F-Gas Handling
- Unvented Hot Water Systems
- Mechanical and Electrical Conversion

# Livingston Centre

We also offer bespoke training solutions to suit your needs. These solutions can have their own benefits to you and your team:

**View on Google Maps or What3Words:**

5 Deer Park Avenue, Fairways Business Park,  
Livingston EH54 8AF  
[///train.pets.walks](https://train.pets.walks)



## Our Facilities

5 Deer Park Avenue, our Livingston Centre, is complete with 4 spacious classrooms, 1 efficiently condensed practical area, and is within walking distance of the local Premier Inn accommodation.

This centre offers a convenient solution to our clients in Scotland who may wish to lessen their travel time and remain closer to home. Situated just off of the M8, (JCT 3) this centre is also located close to the Deer Park Golf Course, also on the Fairways Business Park.

The centre is staffed by our Livingston team, comprising of tutors and dedicated client services team member.

### Classrooms

### Practical Facilities

#### 5 Deer Park Avenue

- |           |  |
|-----------|--|
| - Bateman | - F-Gas Handling                       |
| - Blyth   | - Low Voltage                          |
| - Bruce   | - Mechanical and Pressure Systems      |
| - Weir    | - Mechanical and Electrical Conversion |



## See More Online

View the centre floor plan, see the courses available in Livingston and watch a video tour of the centre by visiting our website:

[ppltraining.co.uk/training-facilities/livingston-centre](http://ppltraining.co.uk/training-facilities/livingston-centre)



# Meet Our Knowledgeable and Experienced Team of Tutors

Staff Profiles



View Online

# Bespoke Training Solutions

We also offer bespoke training solutions to suit your needs. These solutions can have their own benefits to you and your team:



## In-Centre Training

- Multiple centres across the UK
- Wide range of practical facilities
- Safe, quiet and clean environment



## Remote Training

- A variety of live tutor-led courses and self-paced learning
- Cost effective
- Reduced downtime

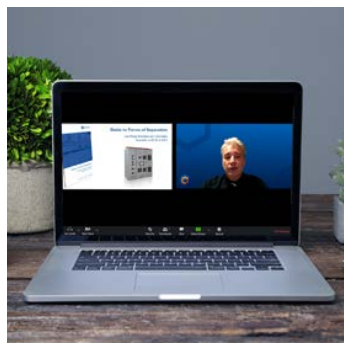

## On-site, at Your Premises

- Reduced downtime
- Dates to suit your team
- Cost effective team training



# Increase your Competency

Our in-centre training offers hands-on practical learning, demonstrations and assessments designed to help ensure the technical competencies of your staff.

## We've Got a Guide for That!

To explain that the majority of our in-centre training is underpinned by practical training designed to increase your competency and technical knowledge, is pretty easy to do...

However, to show you what our practical training facilities look like, in a way that you can appreciate the scale of it, is not as easy! Check out the web page below for more details

 [ppltraining.co.uk/our-latest-training-brochures](https://ppltraining.co.uk/our-latest-training-brochures)



## Enter The Digital Classroom

We offer a selection of live, tutor-led remote training courses, and will soon offer self-paced e-learning options for those who need to train in their own time...



Legionella Management for Water Systems Remote



Legionella Awareness Remote



Water Hygiene Training For Hospital Maintenance Staff HTM 04-01 Remote



Legionella Management for Water Systems HTM 04-01 Remote



Closed Water Systems Awareness Remote



Substation Entry Awareness Remote

For pricing and availability, visit:  [ppltraining.co.uk/training-course/remote-training](https://ppltraining.co.uk/training-course/remote-training)

# At Your Premises, For Your Team

If you have the facilities, we have the expertise. Why not have us come to you? A number of our courses can be delivered on-site on a bespoke basis:

- ✓ 18th Edition Wiring Regulations | City & Guilds 2382-18
- ✓ Hydrocarbon Qualification | City & Guilds 6187-21
- ✓ Aeronautical Ground Lighting Technician
- ✓ Authorised Person Aeronautical Ground Lighting
- ✓ Authorised Person Confined Spaces (Commercial)
- ✓ Authorised Person Confined Spaces Refresher
- ✓ Authorised Person MOD Hazardous Areas
- ✓ Authorised Person High Voltage - Operation and Safety
- ✓ Authorised Person High Voltage - HTM 06-03
- ✓ AP/SAP High Voltage - MOD Sectors
- ✓ Authorised Person Electrical Low Voltage
- ✓ Authorised Person Electrical Low Voltage HTM 06-02
- ✓ Authorised Person Mechanical and Pressure Systems
- ✓ Authorised Person Petroleum
- ✓ Authorised Person Petroleum Refresher
- ✓ Authorised Person Ventilation HTM 03-01
- ✓ Authorised Person Ventilation Refresher HTM 03-01
- ✓ Authorised Person Working At Height (MOD)
- ✓ Authorised Person Working At Height (Commercial)
- ✓ Authorising Engineer
- ✓ Fire Alarms and Detection Systems - Commercial
- ✓ Fire Alarms and Detection Systems - Domestic
- ✓ Competent Person Confined Spaces
- ✓ Competent Person Confined Spaces Refresher
- ✓ Competent Person Electrical Low Voltage HTM 06-02
- ✓ Competent Person Ventilation HTM 03-01
- ✓ Authorised Person Confined Spaces (MOD)
- ✓ Escape Lighting
- ✓ F-Gas Compliance
- ✓ Facilities Management Contract Managers Technical Awareness



High Voltage Awareness



Mechanical to Electrical Conversion



Skilled Person Mechanical and Pressure Systems



Water Regulations



Legionella Management for Water Systems



Legionella Awareness



Legionella and Water Hygiene Control Within Hot and Cold Water Systems



Risk Assessment for Legionella and Water Hygiene Control in Water Systems



Disinfection of Hot and Cold Water Systems



Control of Legionella Within Evaporative Cooling Systems



Legionella Control Refresher and Update



Legionella Control and Management of Hot and Cold Water Services and Evaporative Cooling Systems



Introduction to The Risk of Pseudomonas aeruginosa and Other Waterborne Pathogens



Swimming and Hydrotherapy Pool Operation and Management



Servicing and Testing Requirements of Thermostatic Mixing Valves (TMV)



Water Hygiene Training For Hospital Maintenance Staff



Legionella Management for Water Systems HTM 04-01



Legionella Awareness Hospital HTM 04-01



Legionella and Water Hygiene Control Within Hot and Cold Water Systems HTM 04-01



## Enquire Now

On-site course pricing may vary to those listed elsewhere in this brochure.

Appropriate facilities are required in order for PPL Training to deliver on-site training at your premises. Ask our Account Managers if your facilities qualify.

# How Can We Help You?

Take a look at some of the organisations that have trained with us in 2022 and continue to do so as they look to increase and maintain the competency of their teams...

See More of



Our Clients



## Training for Facilities Management Teams

Our training course programme is a one-stop-shop for Facilities Management organisations who are looking to prove their competency or demonstrate their technical skills with our range of City & Guilds Accredited courses.



"PPL Training offer a premium service with regards to technical training."

"They can offer a one stop solution, the training courses, sorting out accommodation and any other special requirements, just talk to their administration staff.

The instructors/lectures make the sessions very interesting & enjoyable by calling upon their own experiences and many years' time served in industry and services.

The finish product being a recognised qualification."

ISS

City & Guilds Accredited  
Authorising Engineer



# HTM Compliance for Healthcare Estates

We deliver courses designed to help ensure Healthcare providers meet the requirements of NHS HTM guidance documentation. In 2022, 500+ delegates sat these courses. This happened through direct partnerships with NHS trusts or by serving as a training provider for Facilities Management organisations, responsible for healthcare premises.



As IHEEM Knowledge Partners, our team of knowledgeable and experienced tutors will often take part in peer review of upcoming editions of HTM Guidance, ensuring our training is up-to-date and accurate, in-line with the latest standards.

Recently, our portfolio of courses expanded to include training for SHTM guidance with the opening of our Livingston Centre.



**"Great training provider, great tutor, great course content, great venue."**

"The package from start to finish was excellent, from first enquiry to finding out I had passed the course. The most important elements on any course are the content and the tutor. The content met my needs very well but more importantly, the content was expertly delivered, by an excellent trainer.

Ian adapted the delivery of the content to suit our needs and I actually took this for granted until after the exams on the final day while I was reviewing the course. Ian doing this gave us a much greater chance of not only passing the course, but helping us to remember and implement what we had learned when back in our work places.

Ian has a refreshing personality too which really helps when learning quite serious subject matter!

The accommodation was close to the training venue which was helpful. The training venue was a good teaching space and cooled by AC. The workshop with all of switchgear from different manufacturers was a good place to familiarise yourself with switchgear you may not have on site (and for preparing for the exams). The lunches were fresh and more than enough for your average delegate."

Whipps Cross University Hospital NHS Trust

City & Guilds Accredited  
Authorised Person High Voltage HTM 06-03

# Partnering with University Engineers

As AUE Academy Learning and Development partners, and supporters of the AUDE, we have provided a host of Authorised and Skilled Person, Mechanical and Electrical Conversion and Water Hygiene courses to over 20 Universities in the UK.



**"Carl is amazing"**

"Carl was an amazing teacher, he explained everything and answered any questions we had... Can't wait for my next load of training with you guys"

University of Surrey

City & Guilds Accredited  
Authorised Person Mechanical and Pressure Systems

# Servicing Defence

Last year at PPL Training, we welcomed well over 200+ delegates to our centres, who represented the Ministry of Defence or contractors who oversee Estates and Facilities Management in Military environments.



**"Great training provider, great tutor, great course content, great venue."**

"From initial contact with Amanda Scott I found PPL friendly and helpful.

Paul Davey was a very good trainer and the PPL premises at York are very good training facility.

I have applied to undertake the APHVI course and hopefully the follow-on APHV3 with PPL.

Well catered for, the Vegan packed lunch was the best I have received on any training course I have attended from any provider..."

Amey Defence Services

City & Guilds Accredited  
Authorised Person Electrical Low Voltage

# Training for Airfields and Aviation

We offer a suite of training courses designed for all aspects of Airfield Lighting maintenance and management. We welcomed close to 20 of the UK's largest Airports to our centres in 2022, with more receiving on-site training, at their premises.



## "Brilliant Course"

"Steve Martin was excellent and has a vast amount of knowledge. Best course I've ever been on."

States of Guernsey

Aeronautical Ground  
Lighting Technician

# Everyone In-Between

Our existing client base is rather varied, with everyone from large commercial enterprises and small to medium businesses. From Water Treatment firms, to Local Government employees, all have attended our centres.



## "Excellent facilities, course content and facilitator knowledge."

"The course included the right level of detail for my role requirements. The tutor had extensive knowledge and kept the group included with taught content.

The training suite was 5 minutes walk from accommodation and refreshments provided were excellent.

I would highly recommend!"

Safran Group

City & Guilds Accredited Legionella Control and Management of Hot and Cold Water Services and Evaporative Cooling Systems

# Get Social

Let us know how we did, or follow us to keep an eye out for news, reviews, course information and events that might be of interest to you...

## Join The Conversation

Our posts in 2023 have reached over **10,000 LinkedIn users**, that's up from 3,900 users in the same period of 2022.

**10K**  
connections

📈 **164%** from 3.9K

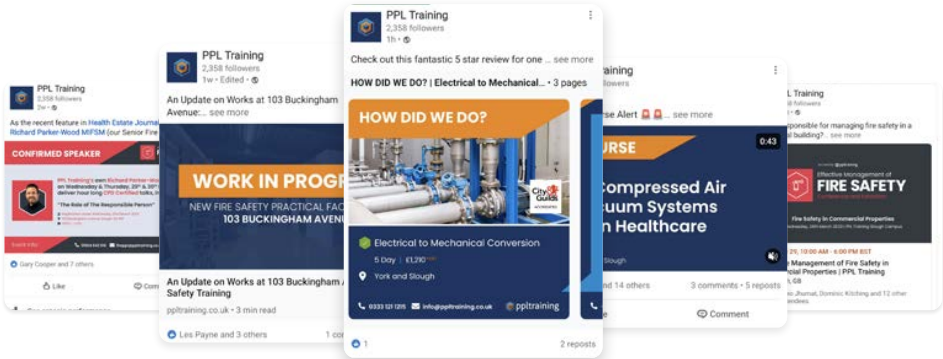

NEWS | REVIEWS | VIDEOS | EVENTS | PEOPLE | TRAINING

Follow Us



On LinkedIn

Help us reach our target of 3000 followers by the end of 2023!



Lower Trend - PPL Training

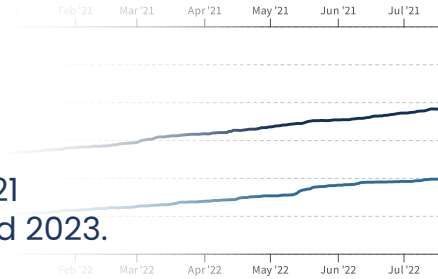

## We're Growing

Our LinkedIn following has grown from 1.7K followers at the end of 2021 to **over 2.3k followers** as we entered 2023.

## How Did We Do?

We've been given a Platinum Trusted Service Award for yet another year, based on us receiving 300+ verified reviews.

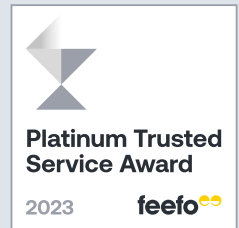

**Did You Know?** Our Authorised Person Low Voltage course was our highest rated course of 2022!



# pplengineering services

We can offer you a personalised solution to your challenges. From regulations, auditing, support and information – we have you covered.



**Authorising Engineer Consultancy**



**Electrical Discrimination Studies**



**Authorised Person Services**



**Compliance Audits**



**Asset/Condition Survey**











**CDM Support**



**Safe Systems of Work**

# **Safe Systems of Work** for Key Engineering Disciplines

	High Voltage		Mechanical and Pressure Systems
	Low Voltage		Confined Spaces
	Medical Gas		Working at Height
	Ventilation		Lifts

Providing Support and Advice for HTM and SSoW Compliance in your Organisation or Trust, Utilising Our Team of Authorising Engineers.

ENGINEERING SOLUTIONS  
UNDER ONE ROOF

Scan the QR code

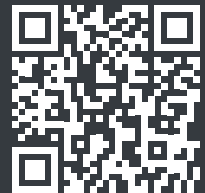

visit our website

# Training Course Index

For ease of reference, we have provided a full list of all of our training course, including remote and on-site courses, in alphabetical order based on their course code.

Course Title	Code	Length	Price Exc VAT
18th Edition Wiring Regulations   City & Guilds 2382-22	2382-22	3 Day	£500
18th Edition Wiring Regulations Amendment 2 - Update	2382-UP	1 Day	£320
Inspection, Testing and Certification of Electrical Installations   City & Guilds 2391-52	2391-52	7 Day	£1,155
Fundamental Inspection and Electrical Testing   City & Guilds 2392-10	2392	4 Day	£750
Design and Verification of Electrical Installations   City & Guilds 2396	2396	5 Day	£875
Electric Vehicle Charging Equipment Installation   City & Guilds 2919-01	2919	2 Day	£455
Hydrocarbon Qualification   City & Guilds 6187-21	6187	1 Day	£325
Authorised Person Aeronautical Ground Lighting (MOD)	AGLMOD	Price on Request	
Aeronautical Ground Lighting Maintenance (Systems Management)	AGLSM	3 Day	£895
Aeronautical Ground Lighting Technician	AGLT	5 Day	£1,385
Authorised Person Aeronautical Ground Lighting	APAGL	3 Day	£895
Authorised Person Confined Spaces (Commercial)	APCS	4 Day	£1,195
Authorised Person Confined Spaces Refresher	APCSR	3 Day	£895
Authorised Person MOD Hazardous Areas	APHAZ	3 Day	£895
Authorised Person High Voltage - Operation and Safety	APHV1	5 Day	£1,385
Authorised Person High Voltage - HTM 06-03	APHV2	5 Day	£1,385
AP/SAP High Voltage - MOD Sectors	APHV3	5 Day	£1,385
SAP High Voltage - Commercial and Industrial Sectors	APHV4	5 Day	£1,385
Authorised Person Electrical Low Voltage	APLV	4 Day	£1,195
Authorised Person Electrical Low Voltage HTM 06-02	APLVH	5 Day	£1,385
Authorised Person Electrical Low Voltage HTM 06-02 Refresher	APLVR	3 Day	£895
Authorised Person Medical Gas Pipeline Systems HTM 02-01	APMGPS	5 Day	£995
Authorised Person Medical Gas Pipeline Systems Refresher HTM 02-01	APMGPSR	3 Day	£795





Authorised Person Mechanical and Pressure Systems	APMPS	4 Day	£1,195
Authorised Person Petroleum	APP	4 Day	£1,195
Authorised Person Petroleum Refresher	APPR	3 Day	£895
Authorised Person Ventilation HTM 03-01	APV	5 Day	£1,385
Authorised Person Ventilation Refresher HTM 03-01	APVR	3 Day	£895
Authorised Person Working At Height (MOD)	APWH	3 Day	£895
Authorised Person Working At Height (Commercial)	APWHC	3 Day	£895
Authorising Engineer	AUENG	2 Day	£625
Fire Alarms and Detection Systems - Commercial	BS5839-1	1 Day	£280
Fire Alarms and Detection Systems - Domestic	BS5839-6	1 Day	£280
Competent Person Confined Spaces	CPCS	2 Day	£525
Competent Person Confined Spaces Refresher	CPCSR	1 Day	£285
Skilled/Competent Person Electrical Low Voltage	CPLV	2 Day	£525
Competent Person Electrical Low Voltage HTM 06-02	CPLVH	2 Day	£525
Competent Person Medical Gas Pipeline Systems HTM 02-01	CPMGPS	5 Day	£995
Competent Person Medical Gas Pipeline Systems Refresher HTM 02-01	CPMGPSR	3 Day	£795
Competent Person Ventilation HTM 03-01	CPV	3 Day	£895
Authorised Person Confined Spaces (MOD)	CSMOD	5 Day	£1,385
Dental Compressed Air and Vacuum Systems for use in Healthcare	DAVS	2 Day	£525
Electrical to Mechanical Conversion	EMC	5 Day	£1,210
Escape Lighting	ESL	2 Day	£445
Legionella Management for Water Systems Remote	EWH001	1 Day	£265
Legionella Awareness Remote	EWH002	1 Day	£265
Closed Water Systems Awareness Remote	EWH013	1 Day	£265
Water Hygiene Training For Hospital Maintenance Staff HTM 04-01 Remote	EWH020	1 Day	£265



Legionella Management for Water Systems HTM 04-01 Remote	EWHH01	1 Day	£265
Legionella Management for Water Systems (Scottish) SHTM 04-01 Remote	EWHS01	1 Day	£255
F-Gas (Category 1)   City & Guilds 2079-11	FCAT1	5 Day	£975
F-Gas (Category 2)   City & Guilds 2079-12	FCAT2	Price on Request	
F-Gas (Category 3)   City & Guilds 2079-13	FCAT3	Price on Request	
F-Gas (Category 4)   City & Guilds 2079-14	FCAT4	2 Day	£495
Fire Door Survey and Inspection	FDSI	1 Day	£280
F-Gas Compliance	FGCOM	2 Day	£525
Facilities Management Contract Managers Technical Awareness	FMTA	2 Day	£525
Fire and Smoke Damper Survey and Inspection	FSDSI	1 Day	£280
Fire Safety Responsible Person Introduction	FSRPI	1 Day	£280
Fire Safety Responsible Person Introduction - Healthcare Premises	FSRPIHP	1 Day	£280
Fire Stopping Survey and Inspection	FSSI	1 Day	£280
Fire Safety Technical Awareness	FSTA	3 Day	£855
Helicopter Landing Areas for Hospitals	HLAH	2 Day	£525
Heliports Visual Aids Principles	HPVA	2 Day	£525
High Voltage Awareness	HVASM	2 Day	£525
High Voltage Maintenance	HVM	5 Day	£1,385
High Voltage Technical	HVTA	3 Day	£895
Introduction to Air Conditioning	IAC	3 Day	£800
Mechanical to Electrical Conversion	MEC	5 Day	£1,210
Skilled Person Mechanical and Pressure Systems	SPMPS	2 Day	£525
Standby Systems	STBS	3 Day	£895
Substation Entry Awareness	SUBE	1 Day	£295
Unvented Hot Water Storage	UHWS	1 Day	£335
Validation and Verification of Healthcare Ventilation Systems HTM 03-01	VVH	3 Day	£895



Water Regulations	WARE	1 Day	£335
Legionella Management for Water Systems	WH001	1 Day	£295
Legionella Awareness	WH002	1 Day	£295
Legionella and Water Hygiene Control Within Hot and Cold Water Systems	WH003	3 Day	£895
Risk Assessment for Legionella and Water Hygiene Control in Water Systems	WH004	3 Day	£895
Disinfection of Hot and Cold Water Systems	WH005	1 Day	£295
Control of Legionella Within Evaporative Cooling Systems	WH006	3 Day	£895
Legionella Control Refresher and Update	WH007	1 Day	£295
Legionella Awareness Within Evaporative Cooling Systems	WH008	1 Day	£295
Written Scheme of Control - Implementation of the Monitoring Requirements for Hot and Cold Water Systems	WH009	1 Day	£295
Legionella Control and Management of Hot and Cold Water Services and Evaporative Cooling Systems	WH010	5 Day	£1,160
Introduction to The Risk of Pseudomonas aeruginosa and Other Waterborne Pathogens	WH011	1 Day	£315
Swimming and Hydrotherapy Pool Operation and Management	WH012	1 Day	£315
Closed Water Systems Awareness Course	WH013	1 Day	£295
Servicing and Testing Requirements of Thermostatic Mixing Valves (TMV)	WH018	1 Day	£295
Water Hygiene Training For Hospital Maintenance Staff	WH020	1 Day	£295
Legionella Management for Water Systems HTM 04-01	WHH01	1 Day	£295
Legionella Awareness Hospital HTM 04-01	WHH02	1 Day	£295
Legionella and Water Hygiene Control Within Hot and Cold Water Systems HTM 04-01	WHH03	3 Day	£895
Legionella Management for Water Systems SHTM 04-01	WHS01	1 Day	£295
Legionella Awareness Hospital SHTM 04-01	WHS02	1 Day	£295
Legionella and Water Hygiene Control Within Hot and Cold Water Systems SHTM 04-01	WHS03	3 Day	£895

# University Estates & Facilities Training Courses

Nationwide, International, and Online

## Training Centres

### York

PPL House, 6 Opus Avenue, York Business Park,  
Nether Poppleton, York, YO26 6BL

### Malton Avenue (Slough)

468 Malton Avenue, Slough Trading Estate,  
Slough, SL1 4QU

### Buckingham Avenue (Slough)

103 Buckingham Avenue, Slough, SL1 4PF

### Tudor Court (York)

Unit 4 Tudor Court, Nether Poppleton, York,  
YO26 6RS

### Bedford Avenue (Slough)

180 Bedford Avenue, Slough Trading Estate,  
Slough, SL1 4RA

### Deer Park Avenue (Livingston)

5 Deer Park Avenue, Livingston, EH54 8AF

## Opening Hours

**Monday – Thursday:** 08:45 – 17:30 | **Friday:** 08:45 – 17:00

## City & Guilds Approved

Courses in line with latest legislation and approved to the high standards of City & Guilds.



## Delivering Excellence as Standard

We have received Platinum Trusted Service Status based on 300+ verified independent reviews (2022/2023). View our feedback online.



## Contact Us

 0333 121 0382

 [info@ppltraining.co.uk](mailto:info@ppltraining.co.uk)

 [ppltraining.co.uk](http://ppltraining.co.uk)



Scan the QR code to save  
our contact information