



VERTICALITY LIGHTING

PROFESSIONAL CATALOG 2021



Access
the
inaccessible®



Access the inaccessible®



Today more than ever, accessing the inaccessible is an everyday requirement for professionals who use our products. For 50 years, Petzl has been applying its expertise and know-how to helping make it happen! Grounded in this experience, we design and manufacture specialized products that provide our users with the best performance and highest level of safety, so that every move they make during their workday is made easier and more efficient, and brings the inaccessible within reach.

In 2021, we're introducing a multitude of new products, starting with the NEWTON fall-arrest harness, which has been completely updated and is now available in three models (NEWTON, NEWTON FAST and NEWTON EASYFIT) and two versions (European and international). Our line of pulleys is expanding with the arrival of the SPIN L1D, SPIN L1 and SPIN L2 high-efficiency pulleys with swivel. For tree care, we're betting that you'll love the new EJECT adjustable friction saver, which is retrievable from the ground. And finally, there is a major addition to our lighting products line: the rechargeable DUO RL headlamp, with a massive 3000 lumens of power, featuring REACTIVE LIGHTING® technology and rugged, waterproof construction.

You'll find many more new products as you go through these pages... Happy reading, and best of success in your endeavors!

The Petzl Team

Key new verticality products	2
Key new lighting products	4
Petzl Custom	5

Petzl: a family's passion	6
Expertise and dedication to quality	8



VERTICALITY

General principles of work at height	12
Rope access and confined space	14
Tree care	20
Energy and networks	24
Framing and roofing	28
General rescue principles	32
Self-rescue	34
On-site rescue	36
Technical rescue	40
Ski lift evacuation	44

Harnesses	48
Helmets	70
Lanyards and energy absorbers	82
Mobile fall arresters	92
Connectors	98
Descenders	106
Rope clamps	116
Pulleys	122
Anchors	128
Ropes	136
Packs and accessories	144
Kits	150

LIGHTING

A line for every use	160
The Petzl difference	161
Petzl quality	162
Brightness and burn time	163
Environments and standards	164
Headlamp specifications	167

Performance headlamps	170
Compact, durable headlamps	178
Ultra-compact headlamps	184

Product index	192
Petzl solutions for outdoors and tactical operations	194
The Petzl Foundation	196
Petzl.com	197

NEW
2021

Key new verticality products

Harnesses

The new NEWTON fall-arrest harnesses are ergonomic, lightweight and easy to use. Available in three models (NEWTON, NEWTON FAST and NEWTON EASYFIT) and in two versions (European and international).



NEWTON
European version
international version



NEWTON FAST
European version
international version



NEWTON EASYFIT
European version
international version

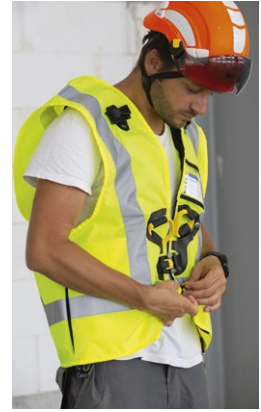

HI-VIZ vest for NEWTON harnesses

pages 50 & 53

Lanyards

New JANE lanyards, available in single (JANE-I) or double (JANE-Y) versions, for assembly with or without energy absorber, to create lanyards customized for progression or fall-arrest.

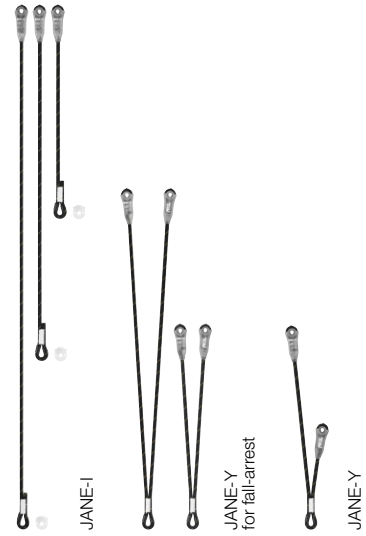

page 88

Pulleys

New high-efficiency pulleys with swivel, available in single or double versions, to optimize complex haul systems, Tyrolean traverses or deviations.



page 124

Anchors

The updated PAW rigging plate (still available in three versions: S, M and L), the new WIRE STROP galvanized steel anchor strap for installing temporary anchors, and the EJECT adjustable friction saver with pulley that is retrievable from the ground.



page 131



page 132



page 134

Ropes

For rescue or technical rescue, the new RAY 11 mm static ropes (can also be used for work at height). For progression using climbing techniques, the new version of the MAMBO 10.1 mm dynamic rope.



RAY 11 mm

page 140

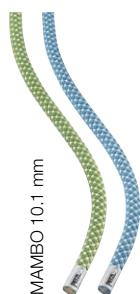

MAMBO 10.1 mm

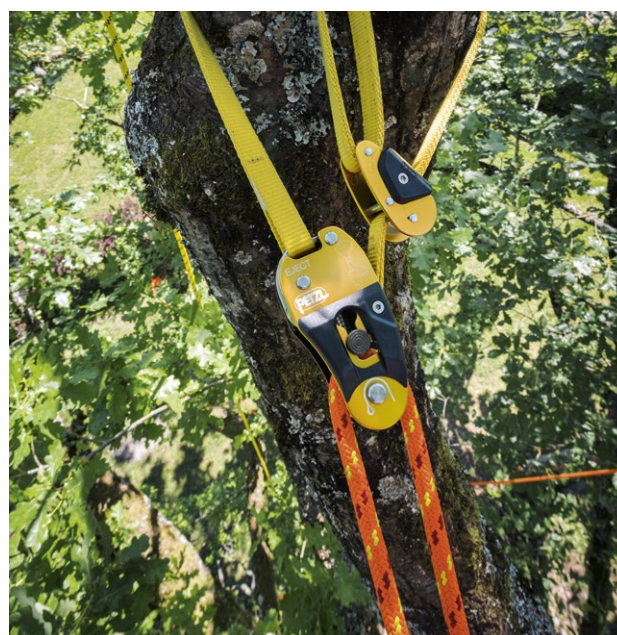

© 2020 Petzl Distribution - Marc Daviet - Champier SARL

Packs

The new DUFFEL 65 and DUFFEL 85 large-capacity transport packs are ergonomic, comfortable and very durable, with a large opening for easy access to contents.



DUFFEL 65



DUFFEL 85

page 146



© 2020 Petzl Distribution - Vuedici.org - SATG

NEW
2021

Key new lighting product

Performance headlamp

For technical rescue and worksites, the new DUO RL headlamp is ultra-powerful (3000 lumens), multi-beam and rechargeable, and features REACTIVE LIGHTING® technology for seeing up close and at a distance. It adapts to any type of helmet, and is waterproof and durable. It becomes the new standard in lighting!



DUO RL

page 172



Technical rescue training with GRIMP 30, Nîmes, France © 2020 - Petzl Distribution - Vuedici.org - GRIMP 30 - VATEL



Personalized products and ready-to-use solutions

Thanks to the Petzl Custom service, you can personalize certain Petzl products. It is possible to manufacture and assemble ready-made products to meet specific user needs, or to identify a product with a company's colors or logo, for example. To take advantage of Petzl Custom service, simply contact your regular Petzl dealer and place your order. Petzl Custom service can personalize helmets, work positioning lanyards, personal escape systems and certain low-stretch kernmantle ropes, static ropes and technical cords.



VERTEX and STRATO helmets

Petzl Custom service can:

- personalize the helmet with a logo and reflective stickers
- pre-mount Petzl eye and face shields and accessories of your choice

onto the helmet, for a ready-made solution, with each helmet delivered in an individual transport pouch

Available for orders of minimum 20 helmets.



VERTEX CUSTOM



STRATO CUSTOM

GRILLON work positioning lanyards

Petzl Custom service allows you to choose:

- lanyard type: standard or high-strength rope
- lanyard color
- lanyard length
- type of lanyard-end connectors and harness connector

The assembly of various components of your choice offers a ready-made solution specific to the user.



GRILLON CUSTOM



EXO CUSTOM

EXO AP HOOK personal escape system

Petzl Custom service allows you to choose:

- type of rope: standard or high-strength rope
- rope color
- rope length
- type of rope-end connectors and harness connector

The assembly of various components of your choice offers a ready-made solution specific to the user, delivered in a transport pouch or bag adapted to the length of the rope.

AXIS 11 mm, PARALLEL 10.5 mm and VECTOR 12.5 mm low-stretch kernmantle ropes; RAY 11 mm static ropes; and the SEGMENT 8 mm technical cord

Petzl Custom service allows you to choose:

- rope color
- rope length
- type of termination (sewn or not, only on low-stretch kernmantle ropes)



CUSTOM ropes

	References	
VERTEX CUSTOM	A010XY	Comfortable, customizable helmet
STRATO CUSTOM	A020XY	Light, customizable helmet
GRILLON CUSTOM	L052XYXX	Adjustable, customizable work positioning lanyard
EXO CUSTOM	D030XYXX	Customizable personal escape system
AXIS 11 mm CUSTOM	R074DA	Customizable low-stretch kernmantle rope with good handling for work at height
PARALLEL 10.5 mm CUSTOM	R077DA	Customizable low-stretch kernmantle rope, flexible and lightweight for rope access
VECTOR 12.5 mm CUSTOM	R078DA	Customizable low-stretch kernmantle, high-strength rope with excellent handling, for rescue
SEGMENT 8 mm CUSTOM	R076DA	Customizable technical cord
RAY 11 mm CUSTOM	R100XY	Customizable static kernmantle rope with good grip, for work at height and technical rescue

Access the inaccessible®

Petzl's mission is to create innovative tools and services that allow people to progress, position, and protect themselves in vertical environments, as well as to light their way in the dark. We continually look for the best solutions for user needs in terms of performance, ergonomics, comfort, and reliability. The demands and the commitment of users are what guide our approach to supporting them in their pursuit of the inaccessible. We have stood by their side for over 50 years.

Paul Petzl

Petzl: a name, its values

The Petzl brand on a product has always represented the commitment of the Petzl family to produce the best tools for its users. The adventure began with Fernand Petzl's passion for caving, a passion to which he dedicated his talents as a craftsman. Petzl expertise began to grow with the design and crafting of solutions for ascending, descending, belaying and moving about in the dark. In 1970, the first "Fernand Petzl" brand products were produced in a workshop in Saint-Nazaire-Les-Eymes, Isère, France. The Petzl company was created in 1975 and has grown into an international company that now employs over 800 people. Since its beginnings, it has preserved its family legacy and values: remaining independent and in control of its own decisions, developing a long-term vision, prioritizing people above all, and embracing its commitment to quality. Today, a family council, with Paul Petzl as president, ensures the continuity of the company.

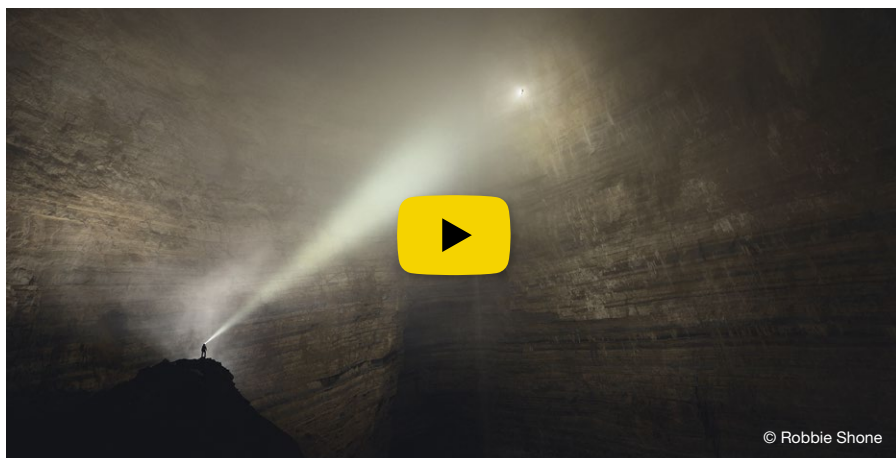
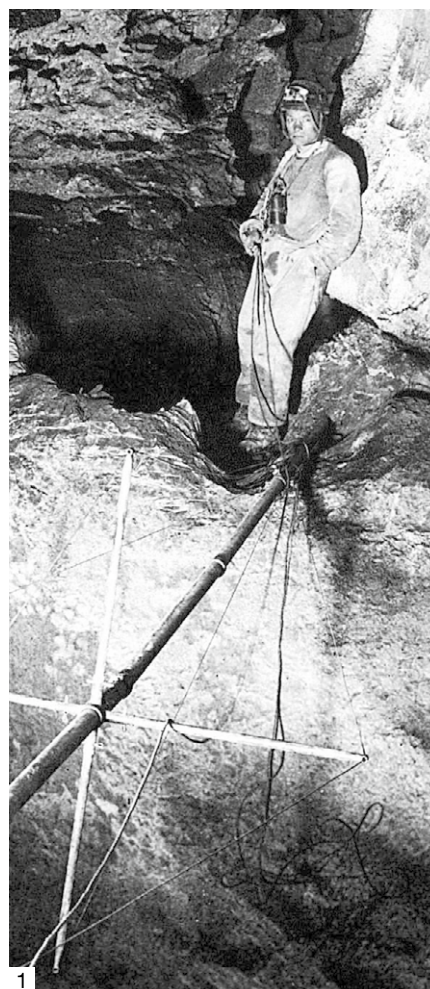

(1) 1940: Fernand Petzl in the Dent de Crolles, France
(2) 1970: Fernand Petzl in his workshop
(3) The Petzl product signature

A pioneering business

To access the inaccessible, you need to know how to reinvent yourself. Since the development of the first rope clamps and descenders, which laid the foundation for rope progression, Petzl has been at the forefront of change and the emergence of new techniques. Headlamp lighting, belaying, rescue, ice climbing, glacier travel... In these and other fields, Petzl innovations have enabled equipment to evolve and practices to be reinvented. As proof of this dynamic activity, over 700 patents have been registered since 1970. These advances always result from a dialogue with the user, in order to understand his/her expectations and to provide the elements s/he needs. Petzl has always remained true to this method.

Petzl's philosophy for design and production is also based on accelerating change, transforming, and innovating in order to provide sports enthusiasts and professionals with the quality products they demand. Testing tower, experimentation center, individual inspections, LEAN manufacturing process - Petzl was a pioneer in all of these innovations.

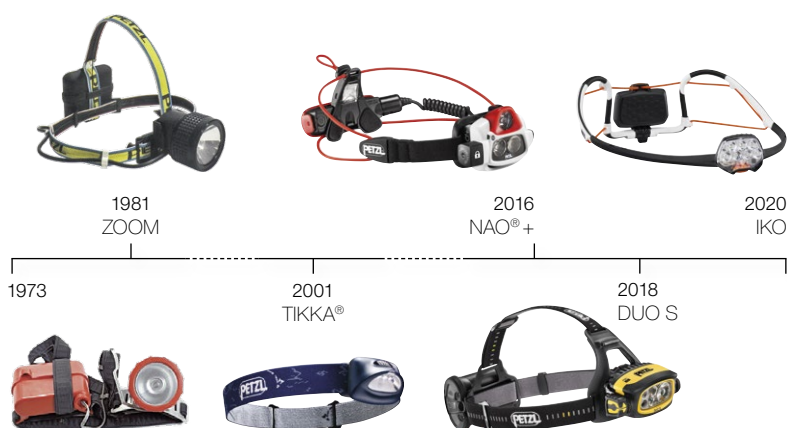

Education, communication

From the beginning, we have sought to provide technical answers to our users' needs. The answers come in the form of product design, but also in the sharing of our experience with verticality. This experience can be found in the technical notices for products, and in the technical advice in our catalogs and at Petzl.com.

The Petzl Solutions department is dedicated to education, through the sharing of our technical expertise. Petzl Solutions provides technical education modules and makes them available through a network of Petzl Technical Institutes around the world.

In order to share our values, we collaborate with top athletes in different disciplines. Mountaineers, climbers, trail runners, cavers... they are the ambassadors of our company and of the passion for the inaccessible. Many are involved with the fine-tuning of our products. See them at Petzl events, and through their stories on Petzl.com and on our social media platforms.

1936: Fernand Petzl starts exploring the Dent de Crolles, France, and invents the tools he needs

1968: Our first rope clamps and descenders (BASIC, SIMPLE) under the name Produits Fernand Petzl (Fernand Petzl Products)

1973: First Petzl mountaineering headlamp is developed

1983: First Petzl harnesses

1991: GRIGRI®, first assisted blocking belay device

1998: TIBLOC®, ultra-compact rope clamp

2001: TIKKA®, the first LED headlamp

2004: ASAP® mobile fall arrester

2005: Petzl professional helmets

2006: EXO® personal escape system for New York City firefighters

2012: NAO® headlamp with REACTIVE LIGHTING® technology

2013: SIROCCO helmet and ZIGZAG® mechanical Prusik for tree care

2015: SITTA harness for climbing and technical mountaineering

2017: GRIGRI® + belay device

2018: New DUO headlamps with FACE2FACE anti-glare technology

2019: METEOR climbing and mountaineering helmets with TOP AND SIDE PROTECTION

2020: MAESTRO descenders for technical rescue, and ultra-lightweight IKO headlamps with AIRFIT headband and ultra-thin lamp body



Expertise and dedication to quality

For over 50 years, Petzl has built on its expertise in the design and manufacture of products for verticality and lighting. Today, Petzl designs, produces and distributes millions of products around the world. Building a Petzl product requires expertise in a wide range of materials - textiles, metals, plastics - as well as in specific technologies: plastics processing, sewing, injection molding, forging, LEDs, electronics... This expertise allows us to design equipment that meets both the needs of users and the technical requirements for its use: resistance to impacts, abrasion, extreme temperatures...

Design

The Petzl research department in Crolles, France, integrates all the fields related to product design: mechanical, textile, electronic, optical, computing and prototyping. Starting at the design and prototype phases, the reliability of the product and user safety are continually evaluated, with a strong focus on risks to the user.

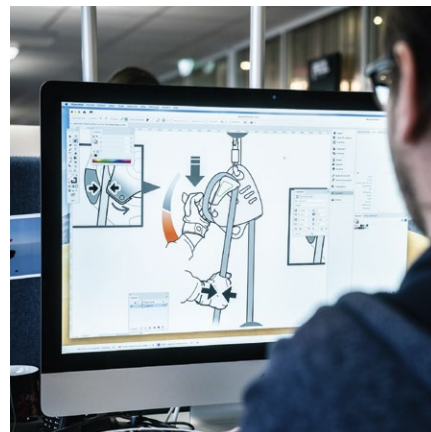
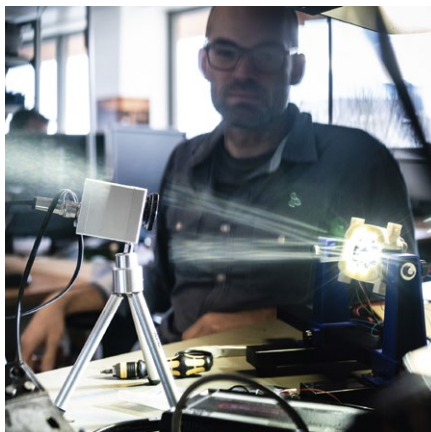

© Stef Candé

Testing

In Crolles, Petzl has labs dedicated to testing verticality products and headlamps. These tests often go above and beyond the required standards to help validate product reliability and user safety. Examples of tests: dynamic fall tests, impact resistance, cyclic testing, performance, headlamp beam quality and burn times. They are complemented by testing in the field for ergonomics and reliability.

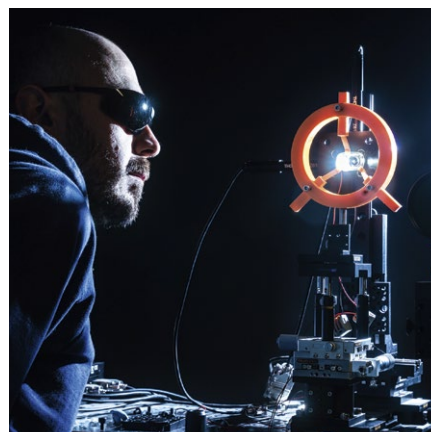

© Stef Candé

Production and inspection

Petzl's production sites are based in Crolles, Eybens, and Rotherens, France, and in Rawang, Malaysia. This production infrastructure is complemented by long-term partnerships with key suppliers in Europe and Asia. Our purchasing and quality control teams work closely with suppliers to guarantee a standard of product reliability and quality that meets our strict requirements. During the manufacturing phase, quality control is present at every step of the production chain. It combines automated and human inspections.

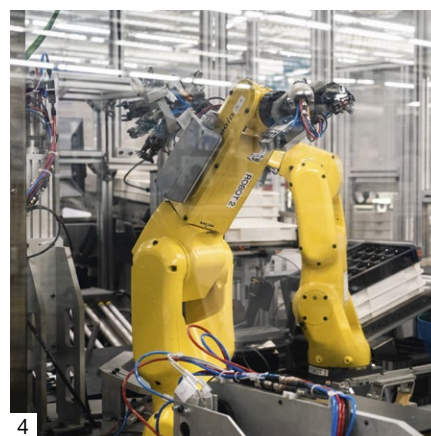
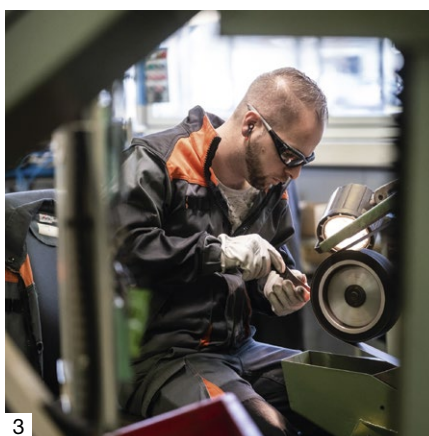

- (1) Head office and manufacturing in Crolles
- (2) Manufacturing in Rotherens, Eybens and Rawang
- (3) Sharpening ice axe picks
- (4) Automated production systems

© Stef Candé

Distribution

Petzl distributes products to more than fifty countries via a distribution network, subsidiaries and agents around the world.



●●●●
 Petzl subsidiaries and agents:
 Austria, Benelux, Denmark, Finland,
 France, Germany, Italy, Norway, Spain,
 Sweden, Switzerland, UK, USA
 ●●●●
 Petzl distributors



VERTICALITY





Petzl's expertise in vertical terrain can be seen in its line of products specifically designed for work at height and rescue professionals. These products address all of the issues faced by professionals every day: repeated and intensive use of equipment, weather, diverse terrain... They maximize usability, simplicity and ease of use, while meeting the highest quality standard.



Equipment inspection and individual identification code

To ensure that your equipment is in good condition throughout its useful lifetime, it is necessary to inspect it regularly. Depending on the product's date of manufacture, the individual identification code can be structured in two ways, with 11 or 13 characters.



Special products in black

Certain products are also available in black; they are designed for professions for whom stealth is essential.

GENERAL PRINCIPLES FOR WORK AT HEIGHT

Warning

- You must have understood and retained the information from your products' Instructions for Use to be able to apply the techniques presented in this document
- Learning appropriate techniques and methods of protection is your own responsibility. Petzl solutions are given for information purposes only, with no guarantee of their effectiveness in your specific working situation. The relevance of these solutions varies by context, so always carry out your own risk analysis in the field
- Mastering the techniques presented here requires specific training and practice. Work with a specialized organization for all of your training activities

General information on falls

The risk of falling is a key concept to master when working at height. The severity of a fall depends on independent factors:

• The weight of the user, including equipment:

The greater the weight, the more energy to be dissipated during the fall.

• The length of the fall:

The longer the fall, the more energy to be dissipated during the fall. The risk of hitting an obstacle is also greater.

• The position relative to the anchor:

When the worker moves above his/her anchor, the severity of the potential fall increases. The fall factor concept is sometimes used to describe the worker's position relative to the anchor and the severity of the fall. This concept applies to climbing, restraint, or work positioning situations, when a dynamic rope lanyard is used.

Precautions for the type of system used:

the Instructions for Use specify the limitations for use of equipment, particularly in terms of fall distance and the worker's position relative to the anchor.

Restraint

A restraint system limits the work zone, keeping the worker from entering an area that may present a fall risk. This system is not designed to arrest a fall from height.

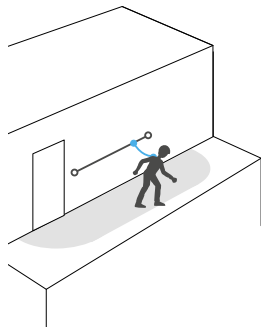

Fall-arrest

The fall-arrest system is a belay system that is independent of the means of progression or work positioning.

The fall-arrest system prevents the user from falling to the ground in the event of a fall. Its role is to arrest the fall while limiting the impact force experienced by the user. It must therefore be used with enough clearance to allow for a free fall.

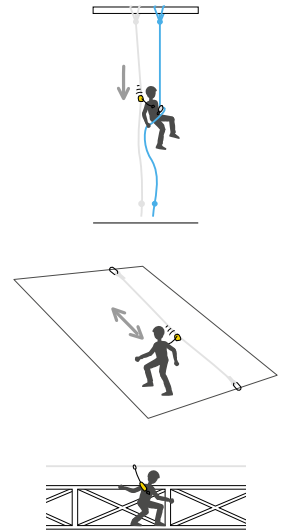

Work positioning

A work positioning system supports the user and allows him/her to be precisely positioned with weight on the feet.

This system is not designed to arrest a fall; the user must keep his/her body weight on the positioning system.

The work positioning system must be used together with a fall-arrest system.

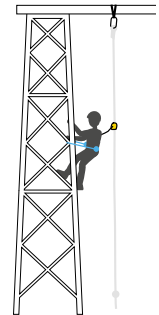

Suspension

The user is working in suspension when s/he no longer has weight on his/her feet, but is supported primarily by the harness. The load is thus shared between the waistbelt and the leg loops/seat.

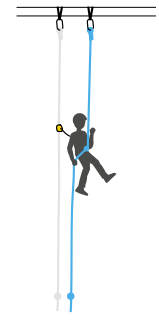

Impact force

A fall-arrest system allows the impact force experienced by the user to be limited.

It is typically made up of an energy absorber that tears in order to limit the forces over a specific stopping distance.

A dynamic rope lanyard has a low capacity for energy absorption. Its use requires taking great precautions: reducing the potential fall distance and staying in a work position below the anchor.

A webbing lanyard or a cable, with no capacity for energy absorption, can not be used to arrest a fall.

Example for 100 kg

JANE or PROGRESS lanyard without energy absorber

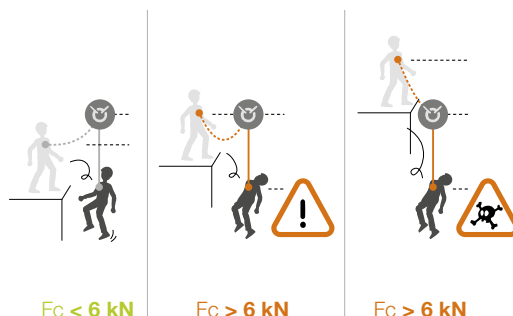

Lanyard with ABSORBICA-I or Y energy absorber

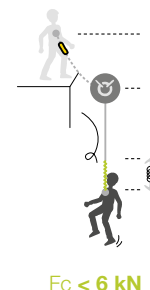

Clearance

Clearance is the minimum amount of clear space below the user that prevents the user from hitting an obstacle in the event of a fall.

Clearance takes into account:

- the user's weight
- the length of the fall
- the tearing length of the energy absorber
- the average height of the user
- a safety margin of 1 meter

Clearance value

The tearing length of the energy absorber, depending on the fall, can only be known based on the manufacturer's information; this is why a clearance estimate is suggested in the Instructions for Use for each fall-arrest device.

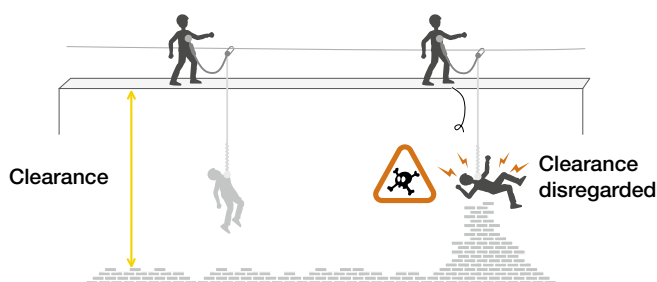

To learn more about calculating clearance, see the technical information available at www.petzl.com

PETZL.COM

Anticipating the means of rapid evacuation

• Limiting the effects of inert suspension:

In the event of a fall where the worker loses consciousness or is incapacitated, inert suspension in the harness presents a mortal danger requiring an urgent response. Work teams must be equipped and trained to quickly evacuate an injured team member.

• Evacuating a victim without assistance:

Procedures for evacuating workers should be determined whenever a new worksite is established.

Releasable systems can be created during installation of working ropes to allow evacuation from below.

Working alone must be prohibited: a worker may find him/herself alone at height, but at least one person trained in evacuations should be present and equipped on site.

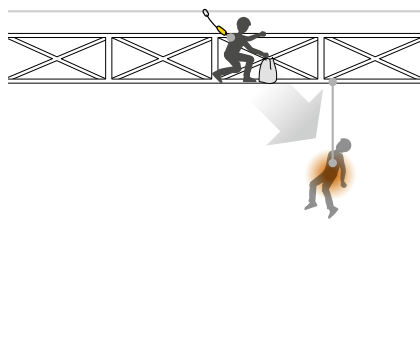

ROPE ACCESS AND CONFINED SPACES

Rock fall protection works near Marseille, France. © 2020 Petzl Distribution - Vuedici.org - Profil - DDITM 13



STRATO VENT HI-VIZ

The STRATO VENT HI-VIZ helmet is very lightweight and comfortable, thanks to its CENTERFIT and FLIP&FIT systems, which ensure that the helmet fits securely on the head. It has ventilation holes that allow airflow through the helmet. This high visibility version features a fluorescent outer shell with phosphorescent clips and reflective bands, for optimal visibility of the worker, day or night. It can be equipped with any of the many accessories that adapt to the user's needs: eye or face shield, nametag holder, nape protector, helmet protector.



Rope access work situations often involve environments at significant height. They can be inside or outside, even confined, and are not suited for the use of collective protection. Work done in confined spaces carries additional difficulties related to the lack of space, and to the lack of means of autonomous progression.

Examples of operations:

- placement of rockfall or stabilization nets over a road
- structural inspection (bridge pilings...)
- exterior window cleaning on skyscrapers
- inspection of tanks

Technical specifics:

- the work area is accessed with ropes by specialized workers trained in rope access techniques
- access from above is preferred, as it is safer and simpler to set up



Rope access

Installing ropes

Load-sharing anchors with the rope.

Bunny knot (for load-sharing anchors).

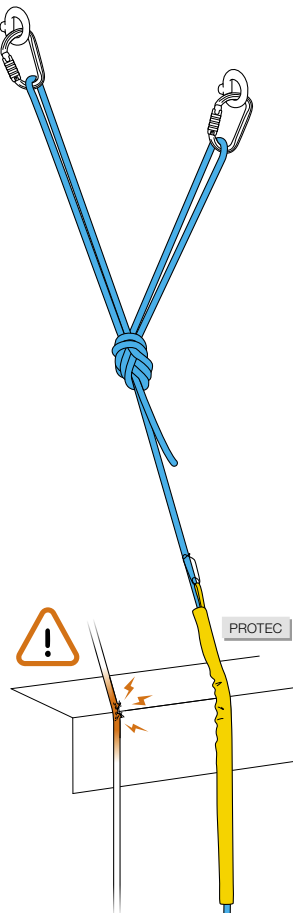
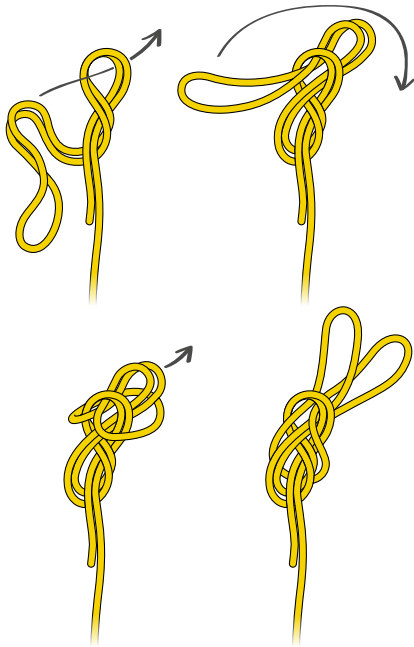

Special case: isolating a section of damaged rope with a butterfly knot.

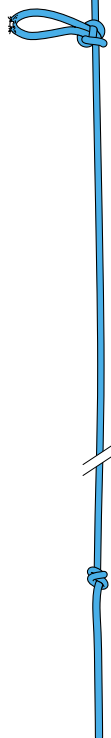
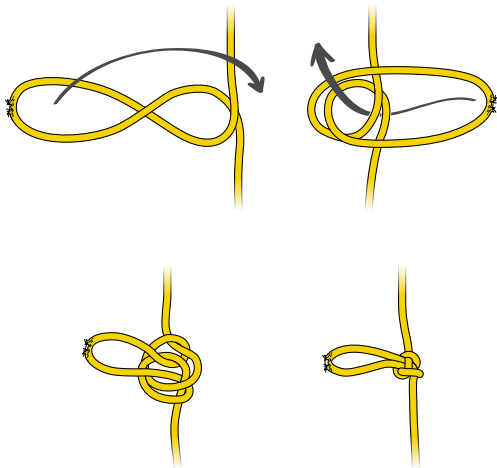

Stopper knot.

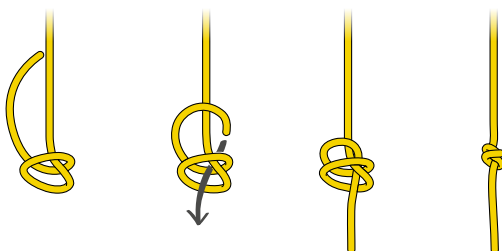

Fixed anchor.

Releasable anchor.

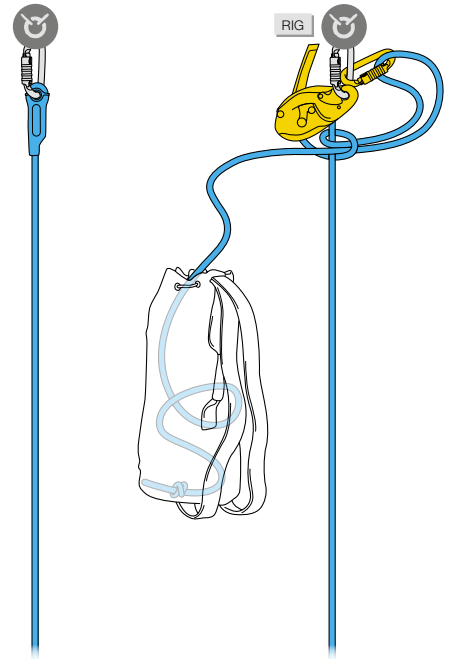

Load-sharing anchors with a sling: effect of the angle on a load-sharing anchor.

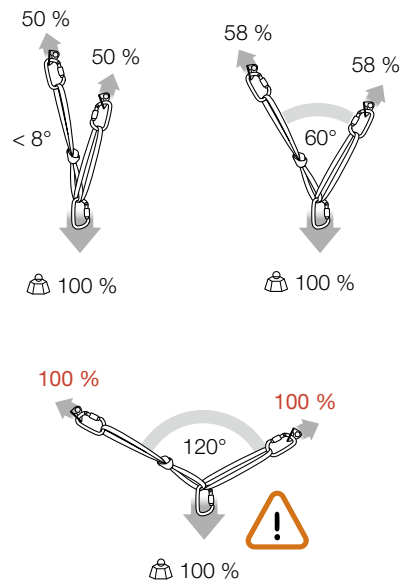

Permanent anchors.

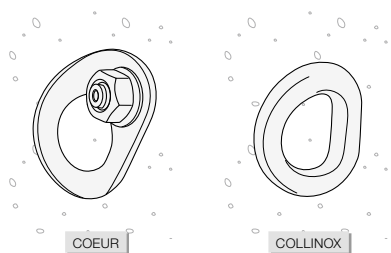

Temporary anchor.

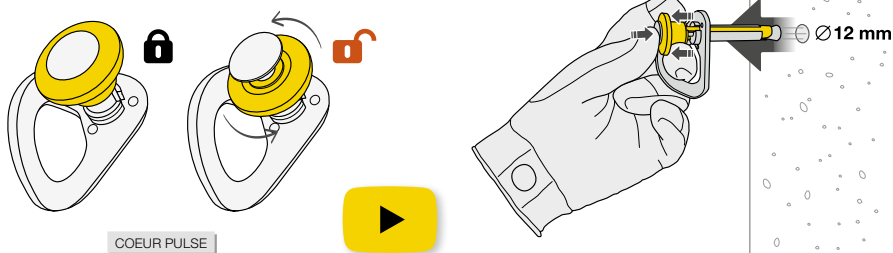

Temporary adjustable anchors.

To wrap around an existing structure by precisely adjusting the length of the anchor.

Large structures

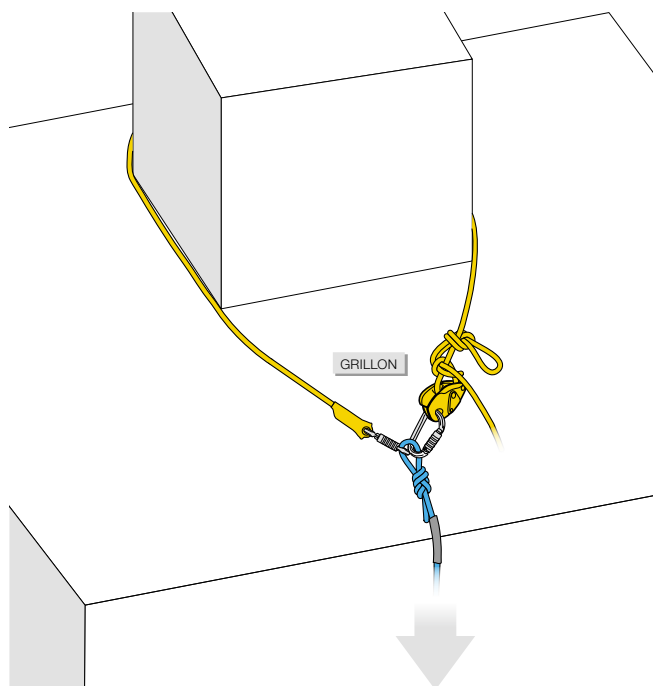

Structures requiring specific positioning

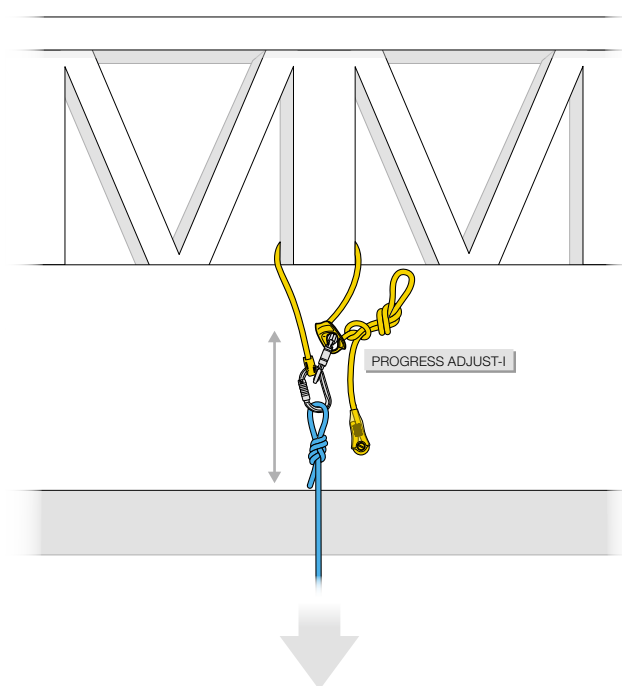

Temporary anchors with multiple configurations.

To best adapt to a situation, whether by connecting directly to the anchor, or connecting to a structure by wrapping around it or using a choker hitch.

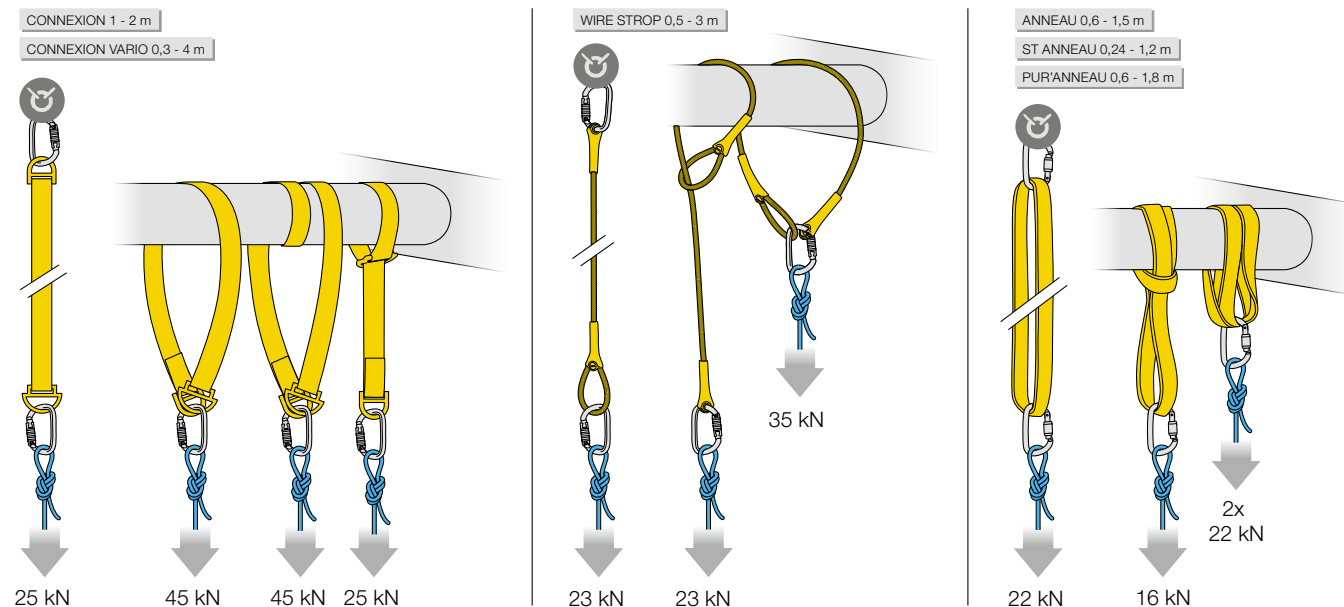

Gated ventral attachment point on ASTRO harnesses

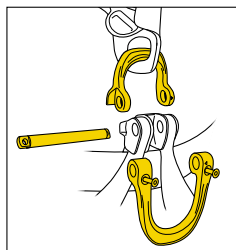

The ventral attachment point on ASTRO harnesses is gated for optimal integration of equipment.

Lowering

The RIG descender attaches to the large metal D.

The PODIUM seat connects to the pin with shackles, allowing a direct connection to the descender while preserving ventral attachment point mobility.

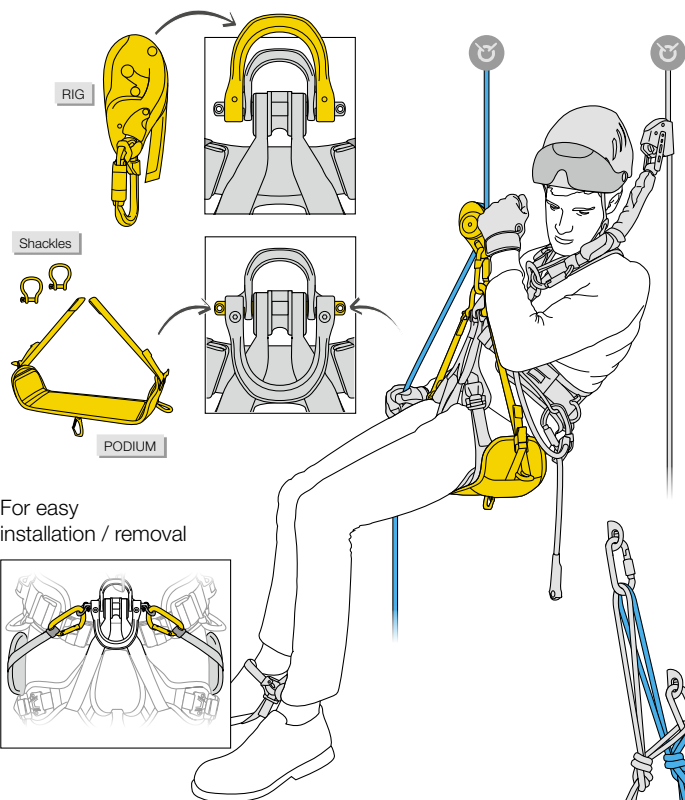

Ascent

The CROLL ventral rope clamp connects to the small metal D for greater efficiency on rope ascents.

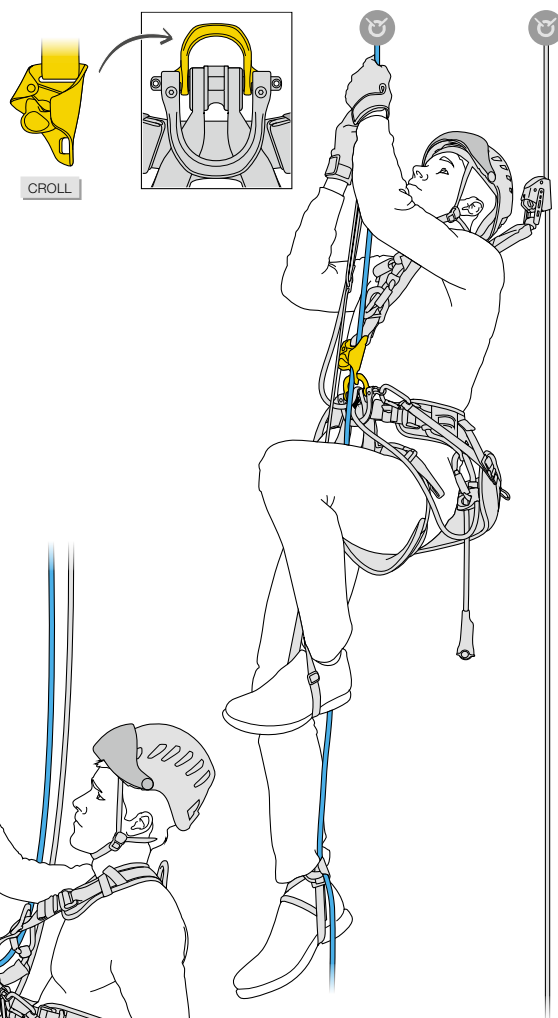

Passing intermediate anchors

The PROGRESS ADJUST-Y lanyard connects directly to the pin, removing the need for a connector.

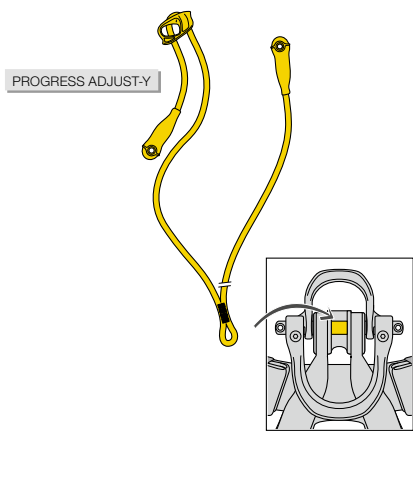

1. Combined lowering/raising system

- Advantage: quick transitions between modes (lowering/raising)
- Disadvantage: rope length is four times the travel distance

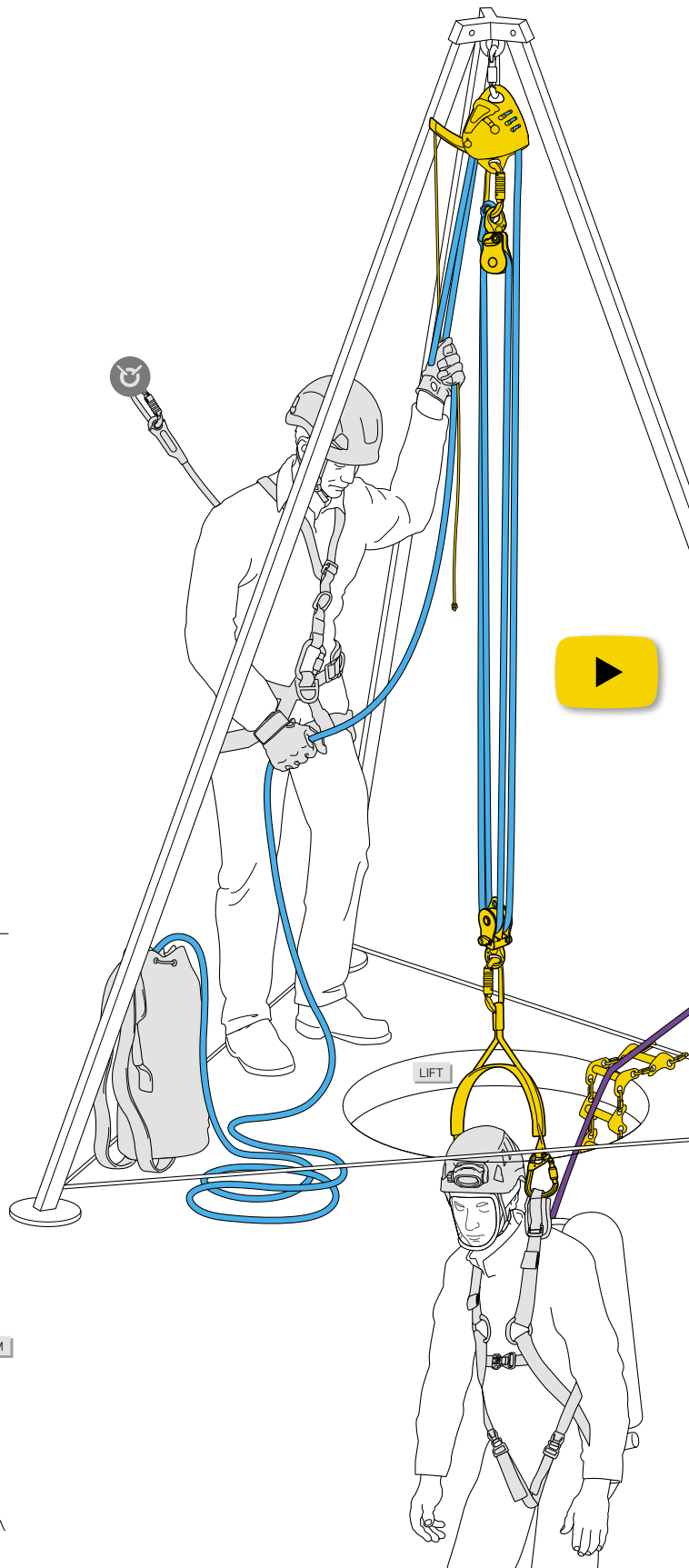
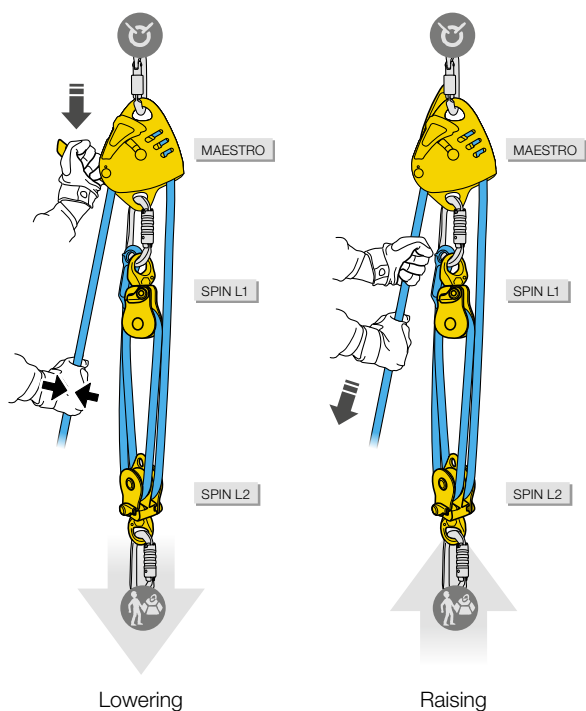

2. Independent lowering/raising systems

- Advantage: the length of the rope equals the travel distance
- Disadvantage: rigging is required to transition between lowering and raising

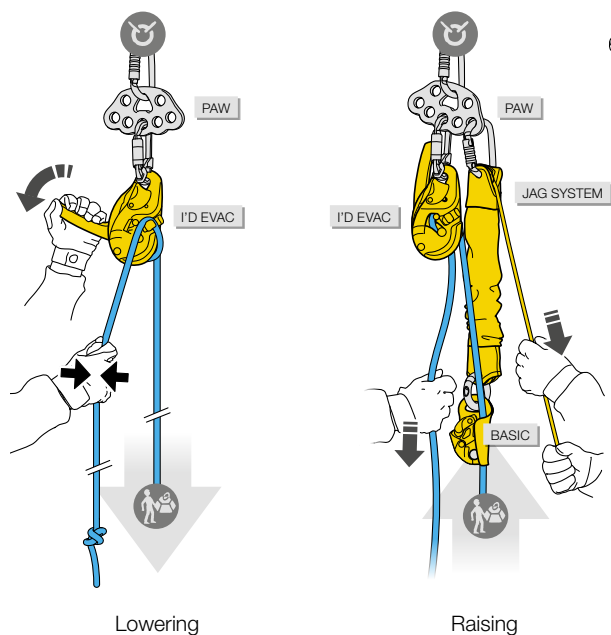

i+ For more information, see technical tips at www.petzl.com

PETZL.COM

TREE CARE

Not all tree work can be done using exterior means such as elevated platforms or ladders. In this case, to move and work, the arborist uses rope progression techniques.

Examples of operations:

- ornamental tree trimming, to adapt the tree to its environment or to change its overall aesthetic
- maintenance trimming to remove dead wood and dying branches
- tree removal (progressive cutting of the trunk from the top) if diseased or presenting a hazard...

Technical specifics:

- access from the base of the tree generally starts by throwing a weighted bag with line attached. This line is used to install the access rope on an anchor up in the tree
- while moving about on the branches, the arborist keeps his/her weight on the work rope, for greater stability and to reduce potential fall distance
- when using any cutting tool (handsaw, chainsaw), the arborist must use two independent belay systems

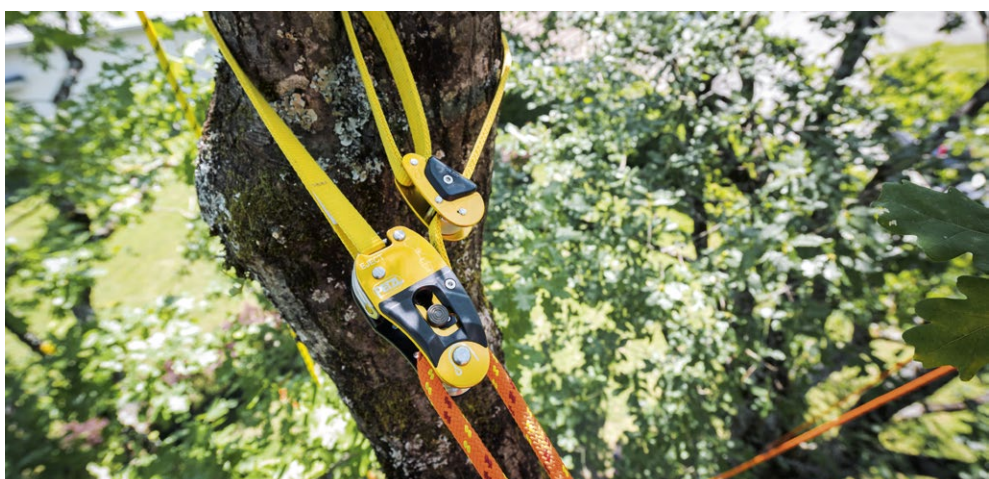
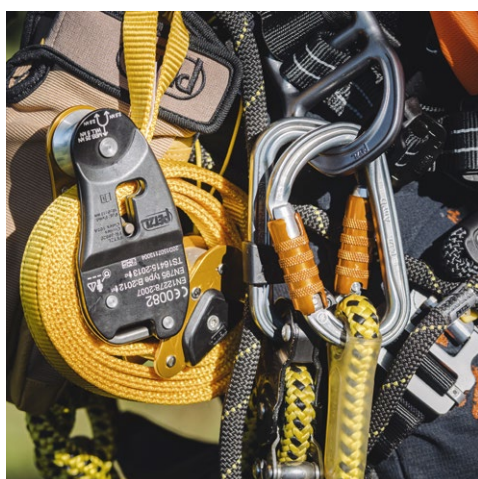
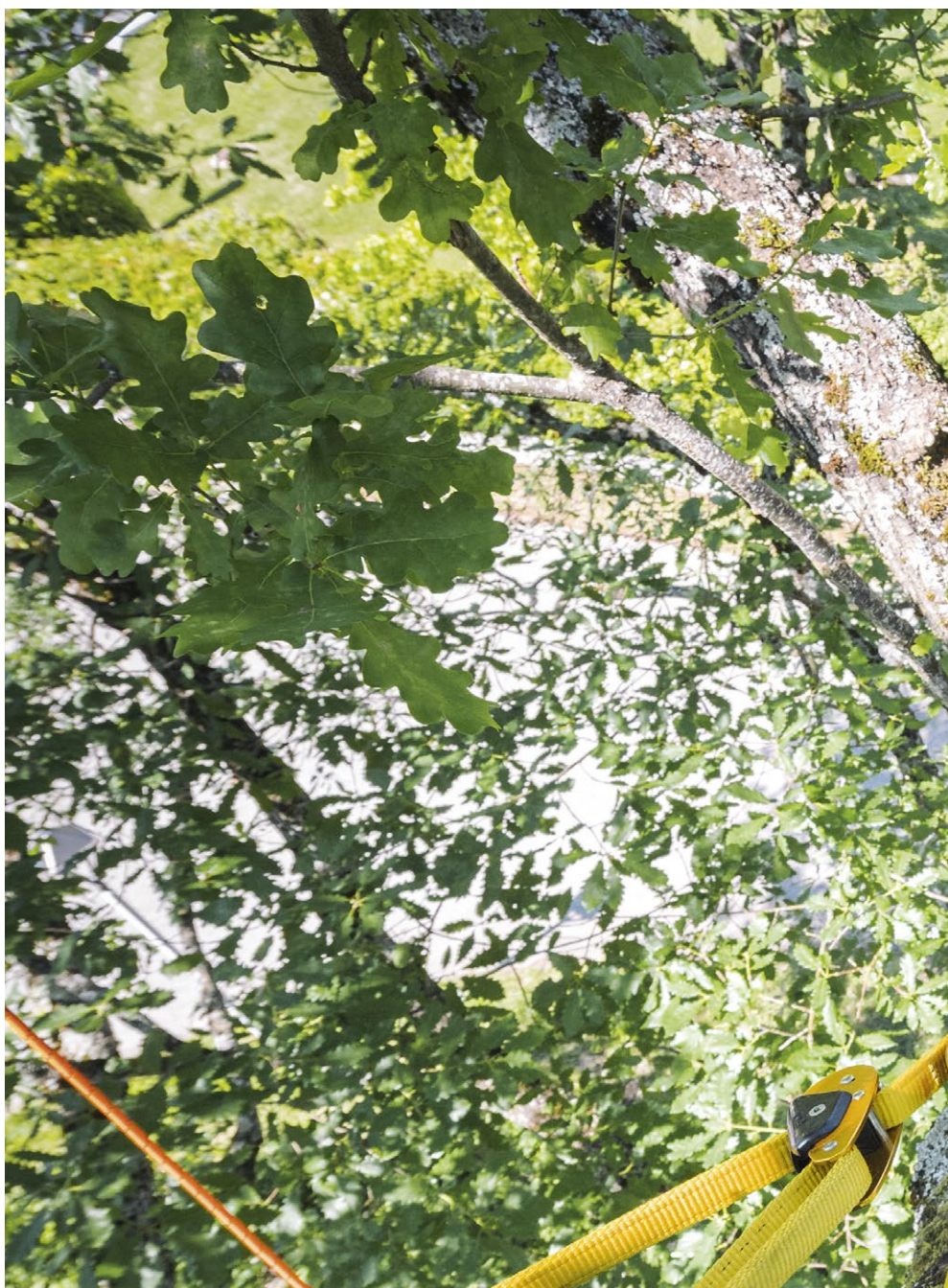

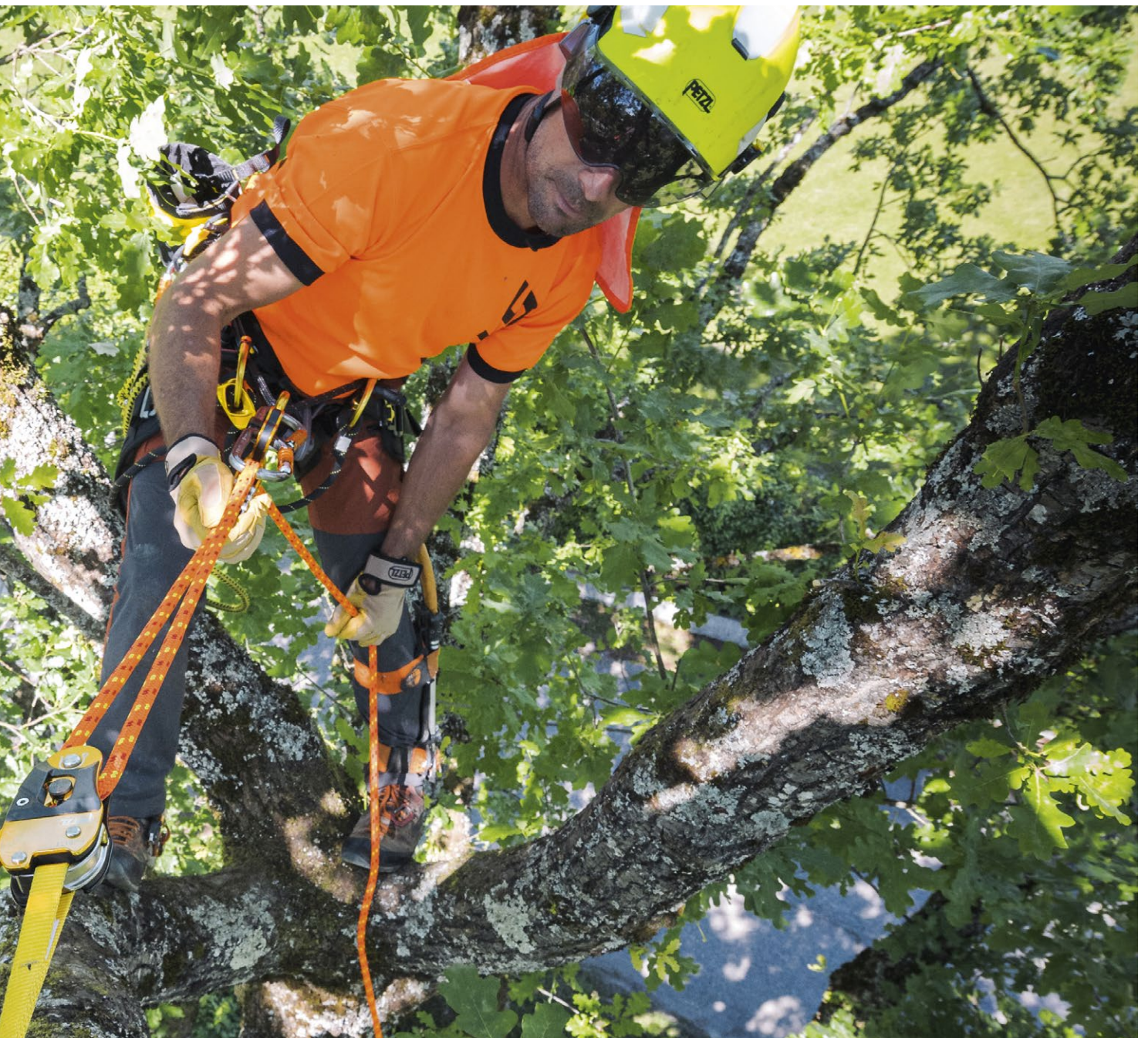

Tree care rope management © 2020 Petzl Distribution - Marc Daviet - Champier SAFL

EJECT

Designed for tree care, the EJECT friction saver allows the work rope to be set up, without damaging the tree, even in narrow forks. It offers multiple setup configurations on one or two branches and has an adjuster that allows precise length adjustment of the friction saver. Rope ascents and movement in the tree are optimized, thanks to the high-efficiency pulley, which facilitates rope glide at the anchor. The included retrieval ball makes the system easily retrievable from the ground.



NEW
2021

Tree access

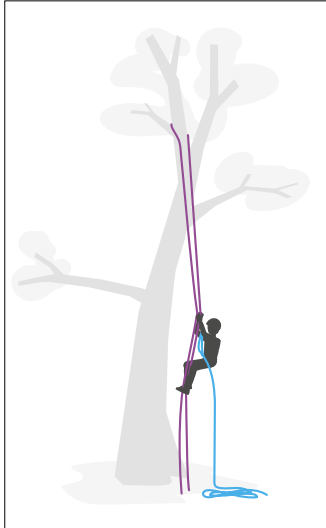

Doubled rope ascent technique

The arborist ascends the access rope (purple). In the event of a problem like a hornet attack, s/he can self-evacuate with the work rope (blue). A mule knot or releasable knot secures the ZIGZAG.

This versatile ascent technique is adaptable to many situations and allows an access rope to be available during work.

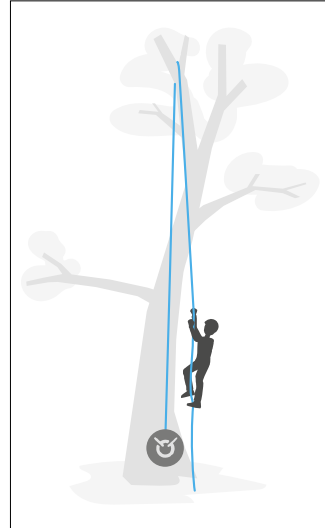

Single rope ascent technique

The access rope is attached to the base of the tree and runs through an appropriate anchor in the tree. It will also be used for work. On a single rope, the ZIGZAG must only be used with the CHICANE.

This technique allows for rapid rescue and efficient climbing with the KNEE ASCENT knee ascender.

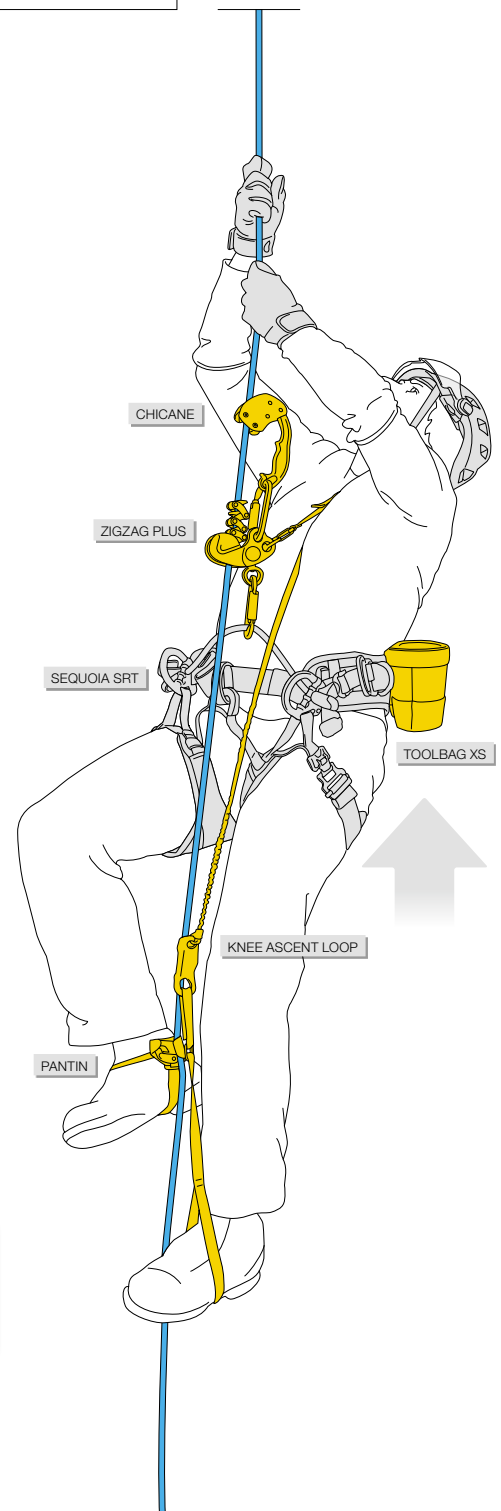
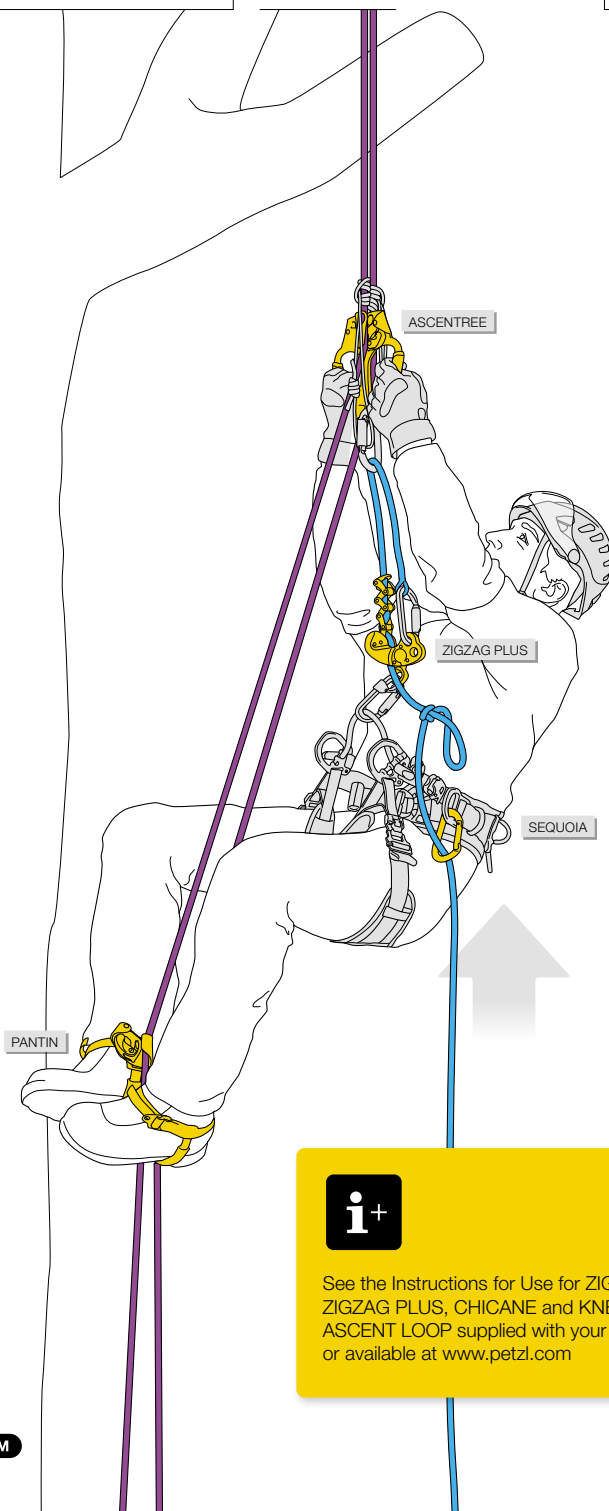

See the Instructions for Use for ZIGZAG, ZIGZAG PLUS, CHICANE and KNEE ASCENT LOOP supplied with your devices, or available at www.petzl.com

PETZL.COM

Movement within the tree

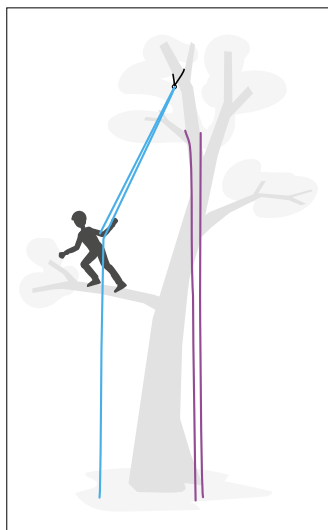

Movement on doubled rope

The work rope is set up doubled through a friction saver, on a suitable anchor near the top of the tree.

This technique allows for easy travel in any direction and provides the arborist with good support when limb walking.

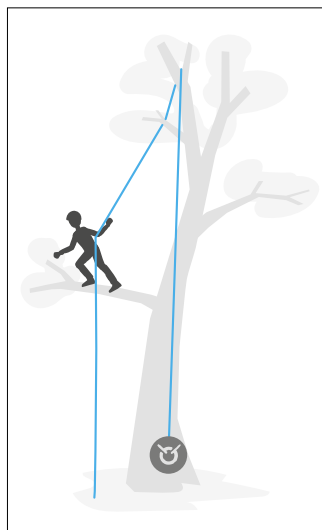

Movement on single rope

The rope setup does not change between access and work: if the top anchor is reliable and verified, the arborist does not necessarily need to climb to the top and can go directly to the workstation.

The rope does not run during movement; the arborist can thus move anywhere in the tree with no loss of efficiency.

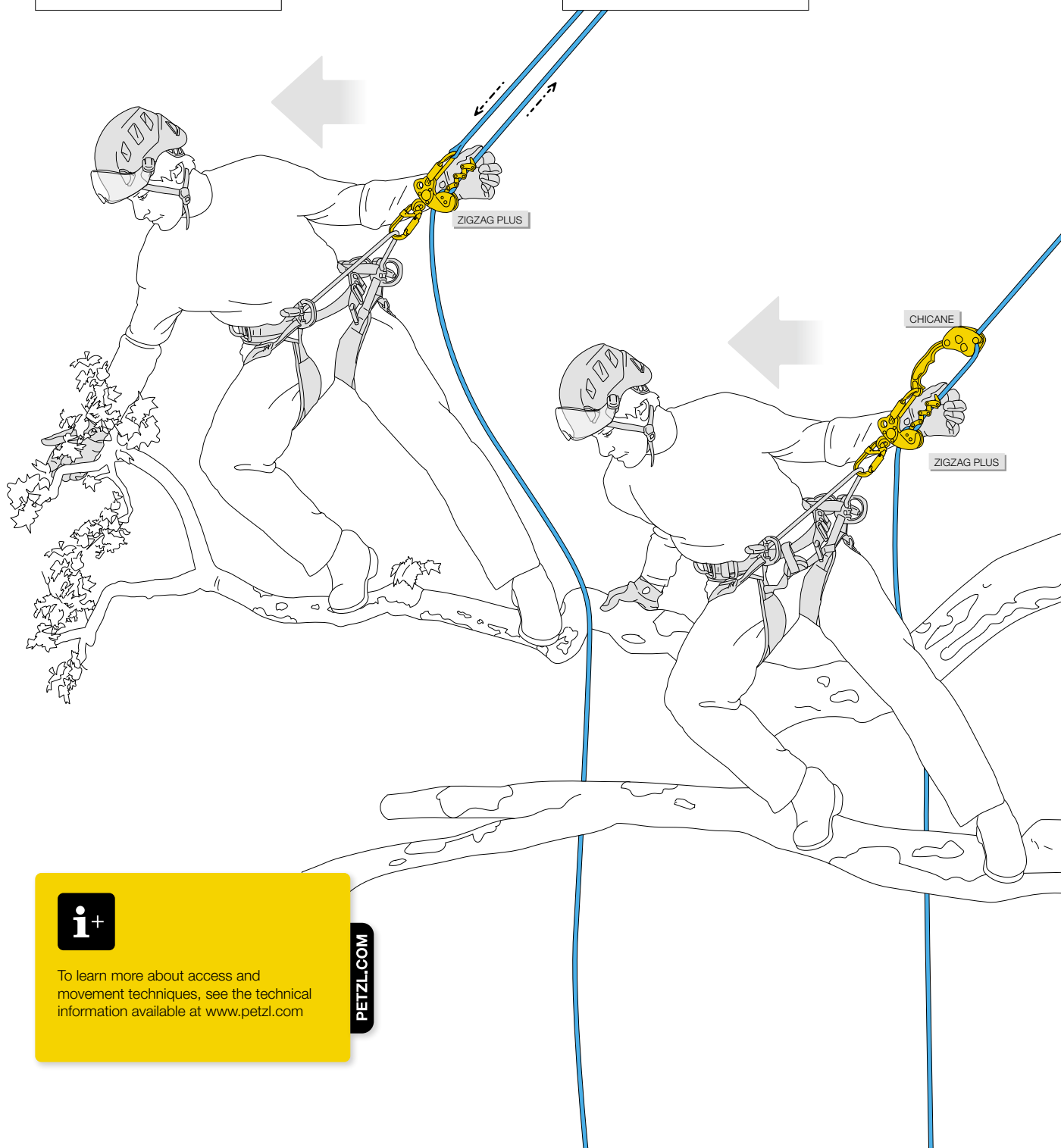

To learn more about access and movement techniques, see the technical information available at www.petzl.com

PETZL.COM

ENERGY AND NETWORKS

Telecom tower maintenance on Frioul Island off Marseille, France © 2020 Petzl Distribution - Vuedici.org - Apesanteur.net - TDF



VOLT European version and ABSORBICA-Y MGO 150 European version

VOLT WIND dons with both feet on the ground, thanks to its automatic buckles. The wide, semi-rigid waistbelt and leg loops give excellent support. The LADDER CLIMB attachment point allows ventral attachment of the fall-arrest trolley. The wear protectors on the waistbelt and dorsal point limit wear when moving about inside the wind turbine tower. ABSORBICA-Y MGO 150 is a double lanyard with compact energy absorber, designed for progression on a vertical structure or a lifeline, and when passing intermediate anchors. The arms are elasticized to avoid hindering progression. It is equipped with two MGO large-opening connectors.



These fields are characterized by structures such as towers, antennas and wind turbines. The modes of progression are varied, and directly related to the structure itself.

Examples of operations:

- work on high tension lines
- tower construction
- maintenance operations in wind farms...

Technical specifics:

- the user generally progresses using lifeline, cable or rail type permanent fall-arrest systems
- lacking these, the user must ensure his/her own safety using personal protective equipment: energy-absorbing lanyard or mobile fall arrester on rope

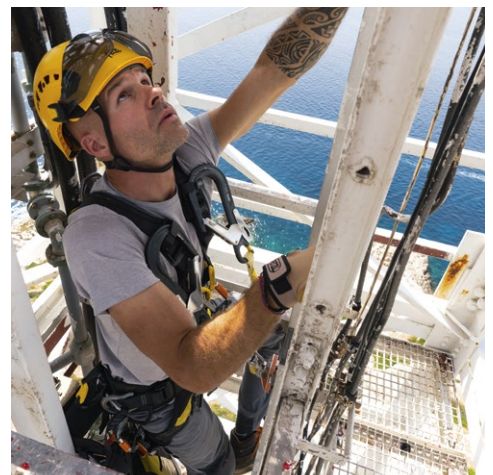

Backed-up ascent using a double lanyard with integrated energy absorber

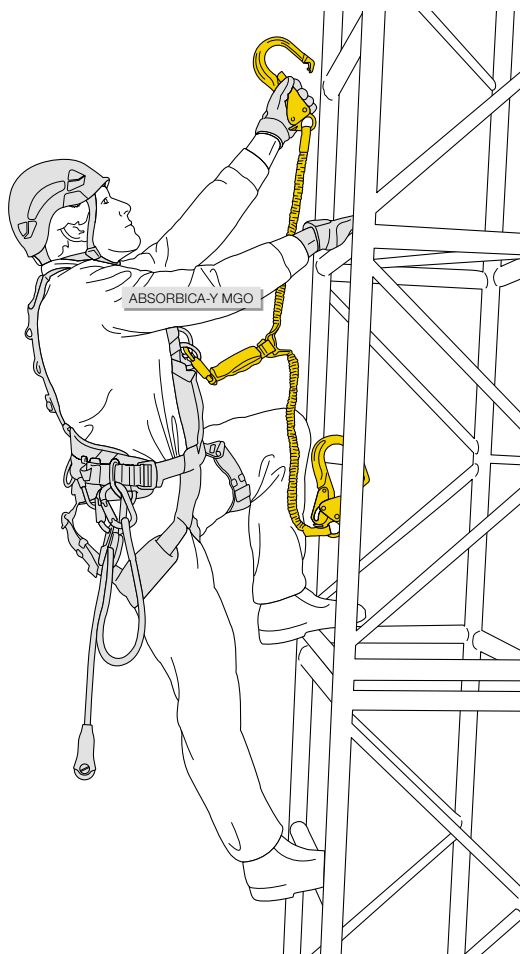

Ascent protected by a fall-arrest trolley attached to a rail

The trolley is fixed to the harness's ventral fall-arrest attachment point (LADDER CLIMB), distributing the load on the waistbelt and ensuring optimal comfort during progression. In the event of a fall, this attachment point moves upward to a sternal position to ensure a vertical post-fall body position.



Work positioning with GRILLON lanyard in double mode use

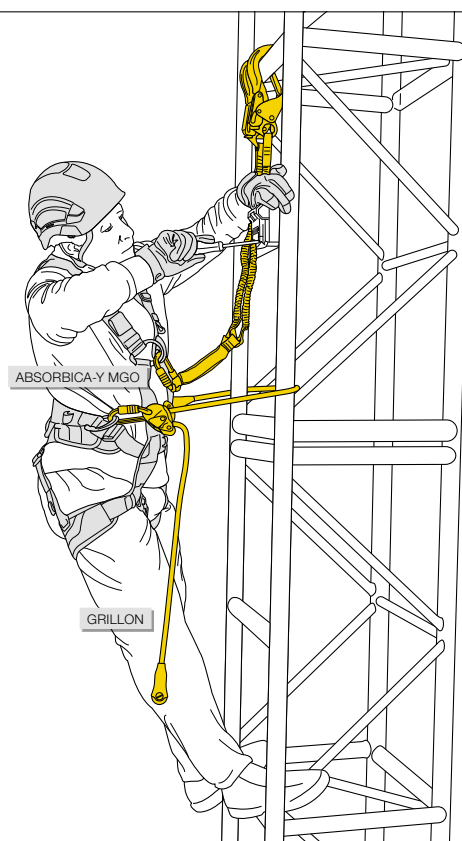

For more information,
see technical tips at
www.petzl.com

PETZL.COM

Descending on a GRILLON 20 m lanyard

The GRILLON lanyard is attached to the ventral attachment point of the VOLT harness.

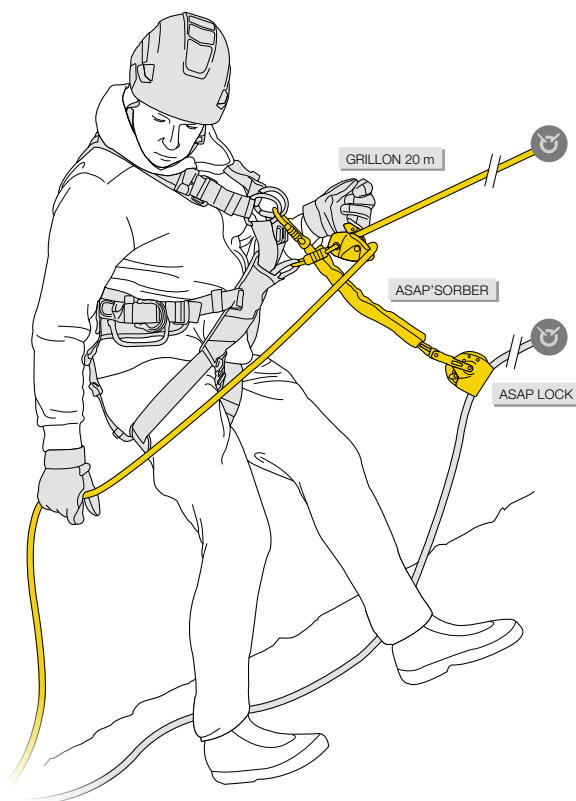

ABSORBICA lanyards and users over 100 kg

In order to remain within the energy-absorbing capacity of ABSORBICA lanyards, a user weighing over 100 kg (with equipment) must reduce the height of a potential fall.

The easiest solution to limit the height of a fall is to use a shorter lanyard.



Recommended lanyard length (including connector), based on user weight:

Maximum user weight	Maximum lanyard length to use	Maximum fall height	Examples of adapted lanyards
50 - 100 kg	2 m	4 m	<p>Am'D + MICRO SWIVEL + ABSORBICA + RING OPEN + JANE-I 150 cm + Am'D</p>
120 kg	1.9 m	3.8 m	<p>Am'D + MICRO SWIVEL + ABSORBICA-I or ABSORBICA-Y 150 + MGO OPEN 60 x2</p>
130 kg	1.8 m	3.6 m	<p>ABSORBICA-Y 150 international version</p>
140 kg	1.6 m	3.2 m	<p>Am'D + MICRO SWIVEL + ABSORBICA + RING OPEN + JANE-I 100 cm + Am'D</p>

FRAMING AND ROOFING

Working from an aerial work platform, Bourg-en-Bresse, France © 2020 Petzl Distribution - Lafouche - LOGNACELLE



NEW
2021



NEWTON EASYFIT international version

The NEWTON EASYFIT fall-arrest harness is ergonomic, comfortable and quick to don, thanks to the foam shoulder straps and automatic FAST LT leg-loop buckles that allow it to be donned with both feet on the ground. Its lightweight, breathable design offers two zippered pockets for stowing small items. The harness allows immediate access to tools, thanks to its equipment loops and slots for the TOOLBAG pouch. Its textile sternal attachment point and metal and textile dorsal attachment points provide tremendous versatility.



In this type of work situation, the risk of slipping and falling is higher. A safety device must be installed to guard against these hazards.

Examples of operations:

- framing a building under construction
- roof repair or waterproofing
- roof inspection on industrial sites...

Technical specifics:

- when the situation allows, accessing the work area is done using an elevated work platform. The worker secures him/herself with an energy-absorbing lanyard
- lacking collective protection, the worker is required to use a fall-arrest system
- fall-arrest systems are also required when installing collective protection

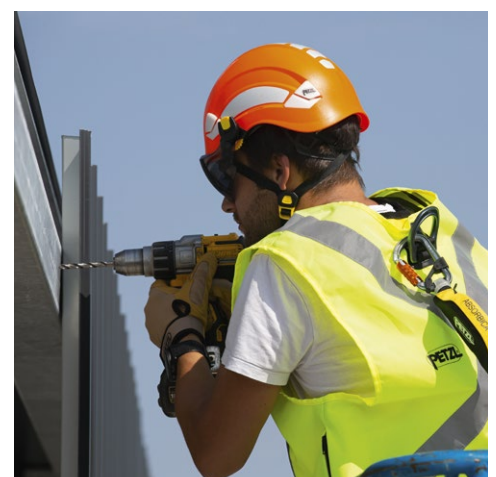

Framing and roofing

1. Roof access

Installing a rope with releasable anchor; backed up ascent with the ASAP.

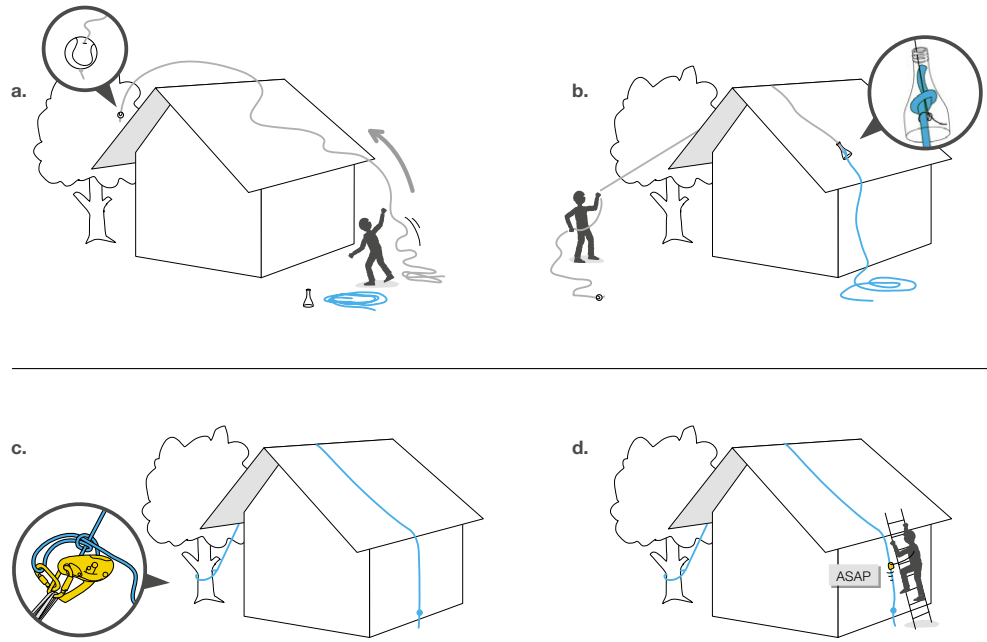

2. Long-term use

With individual positioning system and collective protection.

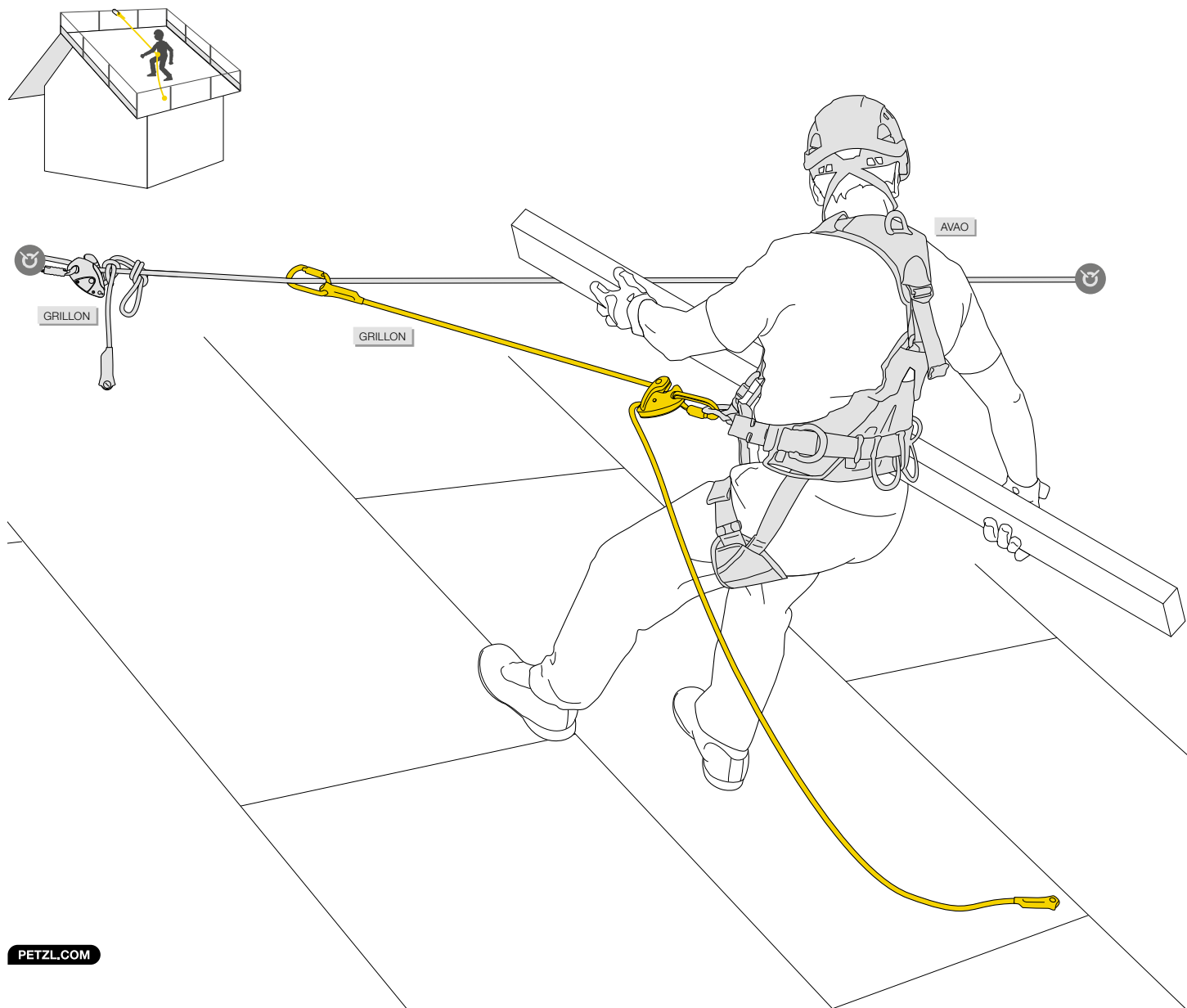

3. Occasional use

With individual fall-arrest system.

- Working in the center of the roof (limited access zone)

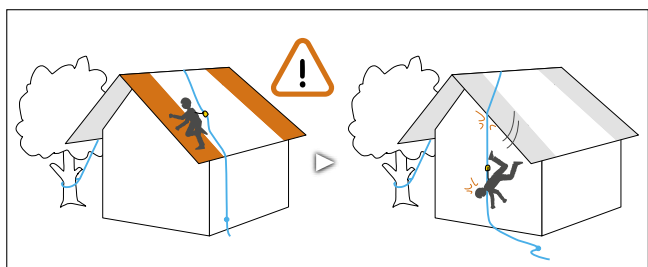
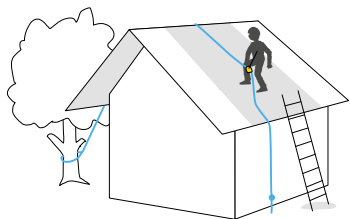

- Working at the edges

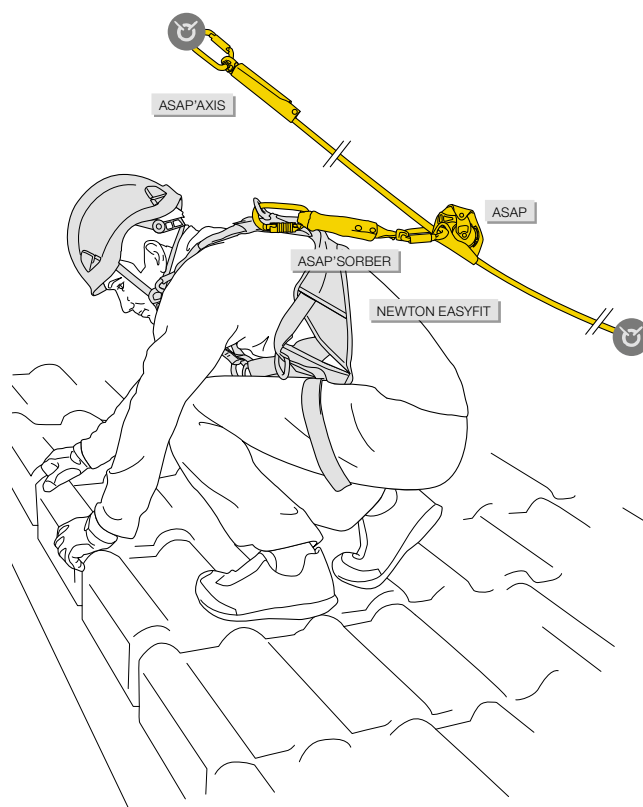
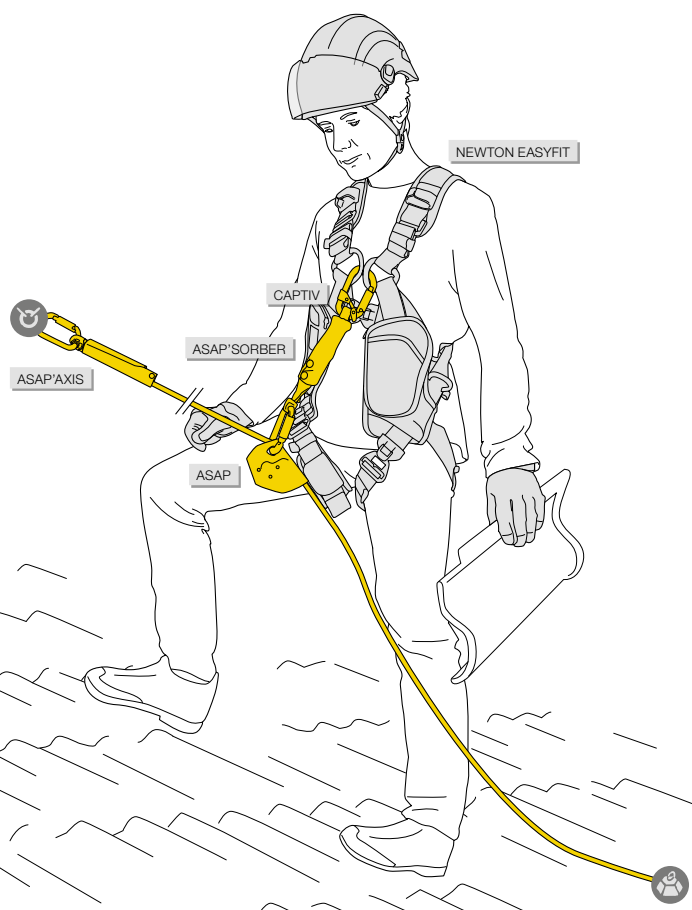
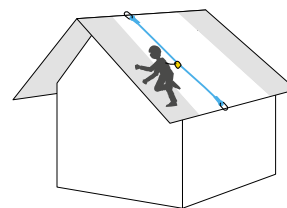

To learn more about using the ASAP on an incline, see technical information available at www.petzl.com

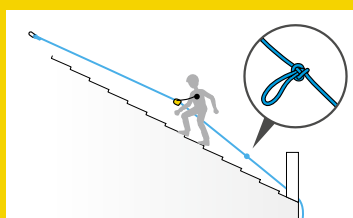

PETZL.COM



For more information, see technical tips at www.petzl.com

PETZL.COM

GENERAL RESCUE PRINCIPLES

Inert suspension in a harness, even for a short time, can cause serious physiological harm. In the event of an accident, it is important to respond quickly with the appropriate technique.

Self-rescue

On sites where the main access could be cut off by fire, people must be ready to quickly evacuate the building. They have evacuation kits. These kits are either portable or installed permanently on the structure. Where there is no identified anchor possibility, a hook-based system can be used. In both cases, teams must be regularly trained so as not to panic in the event of a fire.

On-site rescue

When a worksite is being set up, the company must establish a risk prevention plan (inventory of risk situations):

1. It must protect the personnel from falls from height. The solutions chosen, whether collective or individual, must protect the team members while they work.
2. In the event of an incident, the company must be prepared with rescue systems for accessing, releasing and evacuating the victim.

These solutions are established with:

- ready-to-use rescue kits, adaptable to many situations and simple to use
- personal equipment for the worker at height (solution requiring experienced and well-trained teams)

In both cases, the teams undergo regular training, so they can respond quickly in the event of an accident.

Technical rescue

Technical rescue teams must be able to respond quickly in any situation. They must choose the quickest, most effective way to access the victim.

- When access is easy or possible by motorized means, they can easily transport the rescue equipment
- In more difficult access situations, they may use rope access techniques, from above or below. They thus have lightweight, versatile equipment
- Finally, the helicopter can be a means that is used when victim access is complicated and/or remote, for example in the mountains

Ski lift evacuation

Ski lift evacuation operations follow an evacuation plan. Rescue kits are put together to meet the specific needs of each ski center.

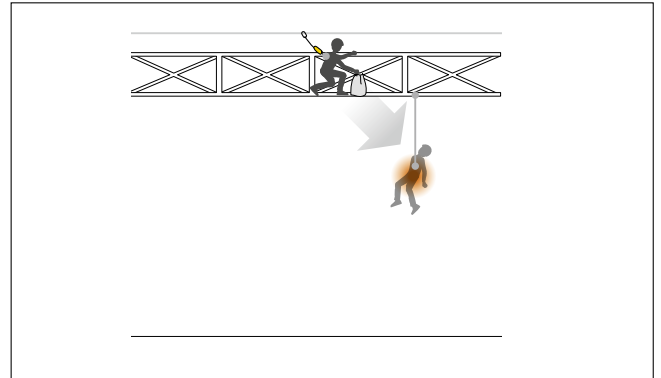

1. Accessing the victim

Accessing the victim can sometimes be complicated. Rope access techniques are used in such a case. When access is possible from above, rescuers use rope descent techniques. If an access rope is in place, rescuers can ascend the rope using handled & ventral rope clamp techniques. In other situations, rescuers are obliged to use climbing techniques to reach the victim.

Example of access from above

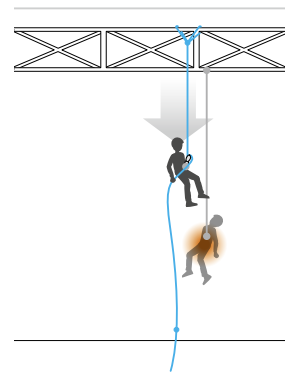

Example of access from below

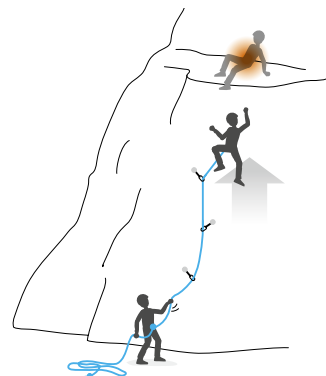

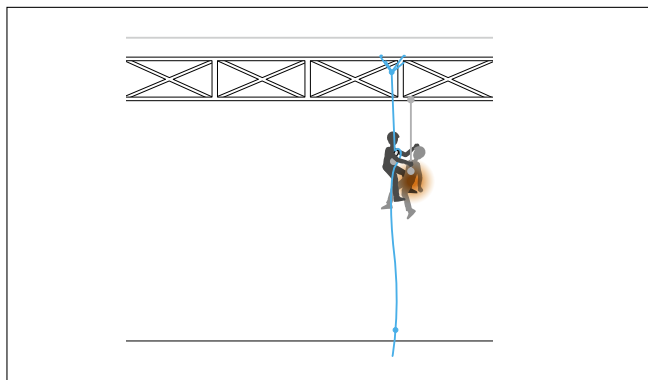

2. Releasing the victim

Raising

This involves using a mechanical advantage pulley system in order to easily raise the victim. A rescuer working alone uses a mechanical advantage system to reduce effort. The disadvantage is that a long rope is required. If there are enough rescuers, a lower mechanical advantage is used to speed up the operation.

Counterbalance technique

This is a counterweight system. The rescuer is on one side, the victim on the other. The rescuer unweights the rope on the victim's side by pulling upward. The victim ascends and the rescuer descends. The advantage of this system is that it is easy to do with little equipment. Engaging the counterweight is the step that demands the most energy. After that, it is important to be careful to keep the system under control. Beware when there is a significant weight difference between the rescuer and the victim.

Example of raising

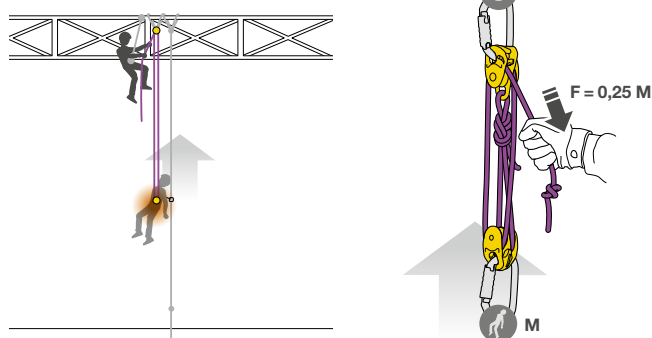

Example of counterbalance

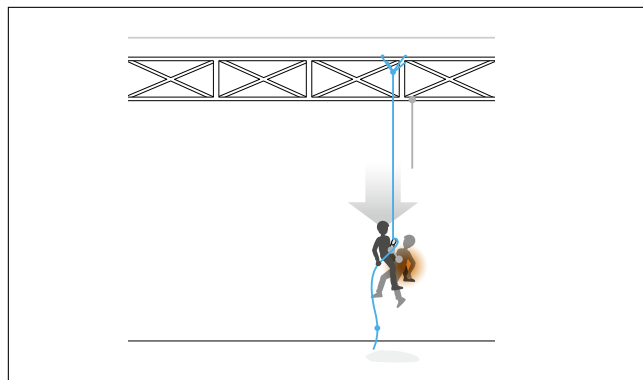
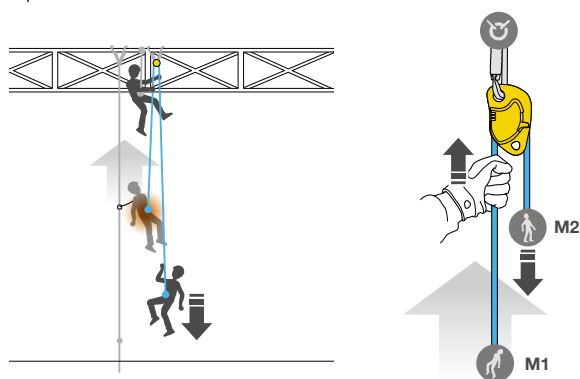

3. Evacuating the victim

Downward, the evacuation is done with a descender. This is the easiest technique currently in use. When downward evacuation is impossible, the victim is evacuated upward or horizontally. Upward, rescuers use either a counterweight or hauling technique. Horizontally, one or more ropes are tensioned. One rope is used for carriage, another is used as a back-up belay, and another to move the litter.

Downward

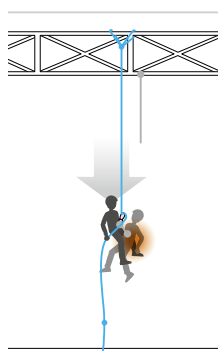

Upward

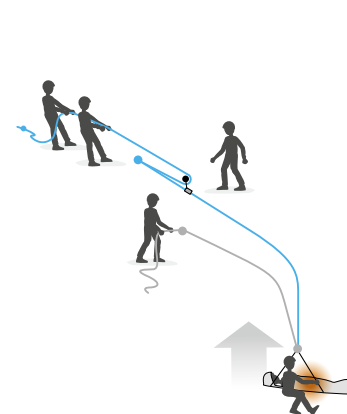

Horizontally

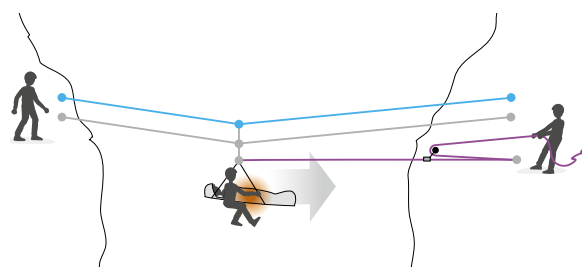

SELF-RESCUE

The typical scenario is of a firefighter trapped inside a burning structure. S/he needs to be able to ensure his/her own rescue and thus must have the appropriate equipment.

Technical specifics:

- in this situation, the firefighter must be able to take advantage of any available anchor point inside the building, or as a last resort, a window sill
- the exit generally takes place in an extremely hot, smoke-filled, and hostile environment, adding to the limitations
- the maneuvers must be as simple as possible, for quick action even under intense duress



Firefighter bailout training, USA © 2019 - Petzl Distribution - ROH - SLC FIRE DPT



EXO AP HOOK

EXO AP HOOK is a personal escape system with an anchor hook, adapted for situations where the possibility of finding an anchor point is uncertain. It has a self-braking system with anti-panic function for quickly moving horizontally, climbing through a window and controlling and stopping a descent. If the user pulls too hard on the handle, the anti-panic function brakes and stops the descent automatically.

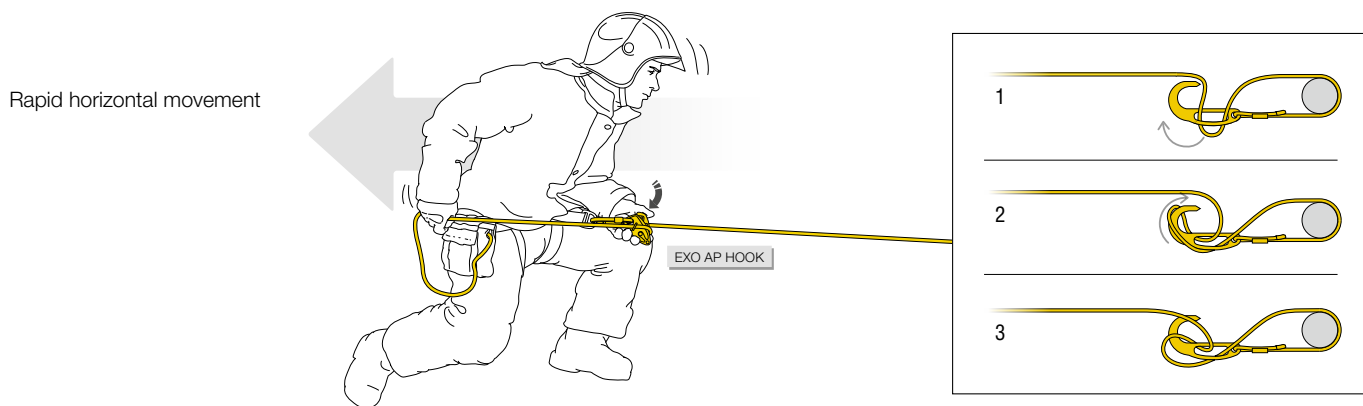

Going through a window while maintaining the anchor hook on the window sill. Locking the left leg against the interior wall to control the movement.

Re-establishment below the window while holding the free end of the rope.

Descending, one hand uses the handle to start the descent, and the other hand holds the rope to control it.

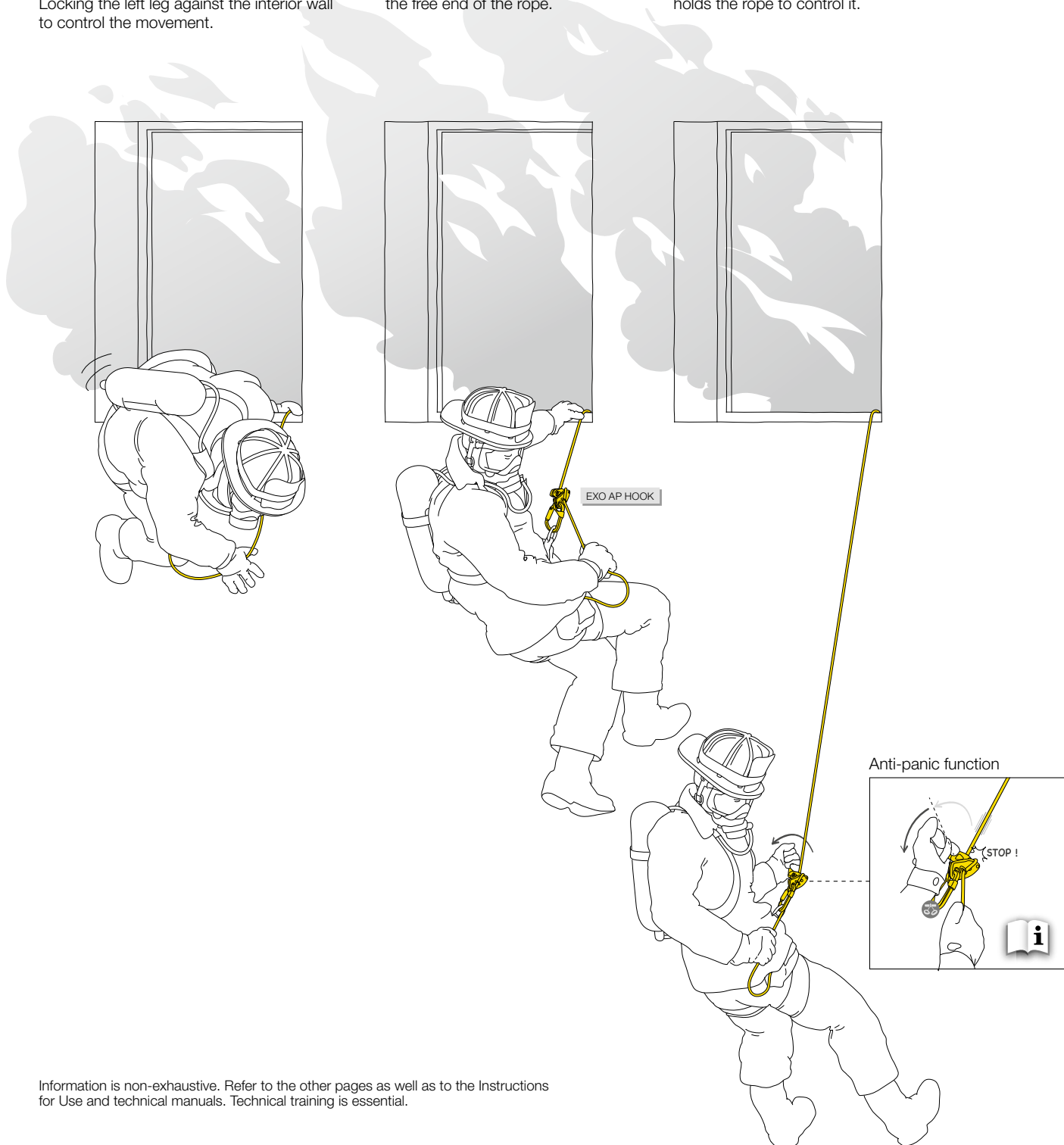

Information is non-exhaustive. Refer to the other pages as well as to the Instructions for Use and technical manuals. Technical training is essential.

ON-SITE RESCUE

Tower rescue exercise, Frioul Island off Marseille, France © 2020 Petzl Distribution - Vuedici.org - Apesanteur.net - TDF

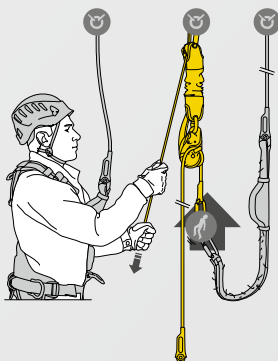

JAG RESCUE KIT

The ready-to-use reversible JAG RESCUE KIT is designed to easily release and lower a victim. It contains a JAG SYSTEM haul kit, a RING OPEN gated ring, an I'D EVAC descender, a CONNEXION FIXE 150 cm anchor strap, a BUCKET bag and an AXIS 11 mm rope with two sewn terminations.



If a victim is not able to self-rescue, the on-site work team has to respond immediately and move him/her to safety.

Examples of operations:

- a team member accesses the victim, unhooks him/her, then lowers the victim unaccompanied
- a team member accesses the victim, releases him/her, then rappels down with the victim
- the victim is suspended on a pre-installed evacuation system that does not require a team member to access him/her directly

Technical specifics:

- unaccompanied evacuation can generally be done using a ready-to-use rescue kit
- accompanied descent requires proper training, as it implies a mastery of advanced rope access techniques
- in all cases, the rescue method should be as rapid as possible, in order to reduce the risk of suspension trauma, especially when the victim is unconscious



Release and evacuation of a victim on a CROLL

Operation from below by a team member with his/her own equipment. The rescuer must carry out a risk assessment before responding and verify (among other things) that the victim's ropes are in good condition. The counterbalance system is used to transfer the victim onto the descender.

The rescuer ascends on the victim's safety line.

1. The rescuer transfers him/herself to the RIG descender, tethers to the victim and moves the ASAP up above the victim.
2. The rescuer puts a second connection in place. S/he can then remove the equipment that is in the victim's way.

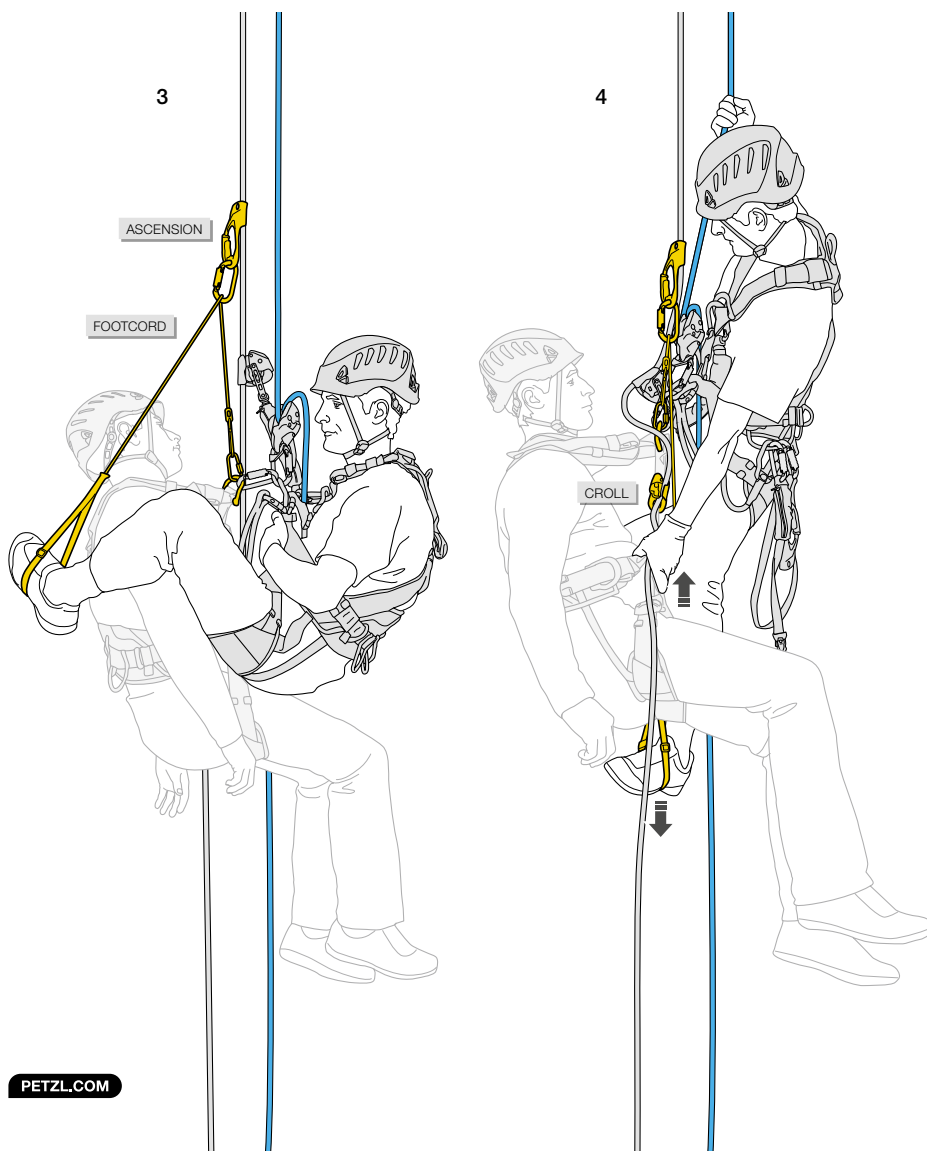
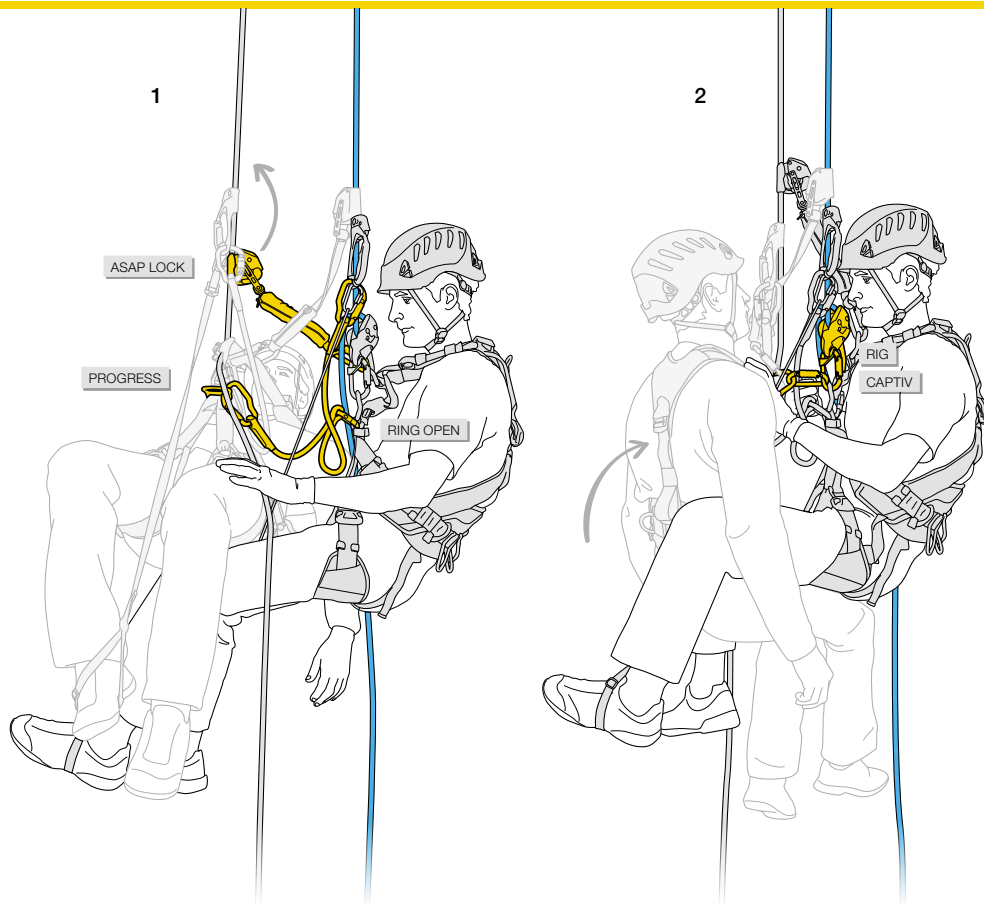

3. On the victim's rope, the rescuer installs a foot loop in counterbalance on the ASCENSION handled rope clamp.

4. In counterbalance on the foot loop, the rescuer prevents the rope from running through the CROLL and raises the victim. S/he removes the CROLL and takes up as much rope slack as possible in the RIG descender.

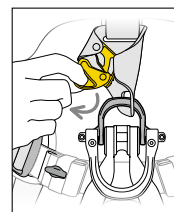

5. The rescuer, hanging on the RIG, recovers the ASCENSION. S/he installs a braking carabiner and accompanies the victim to the ground.

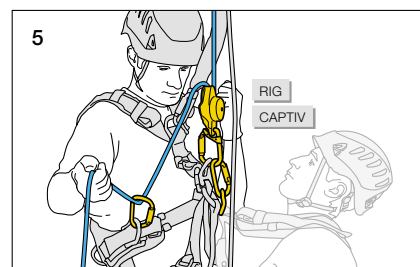

Release and rescue using a reversible rescue kit

• Unaccompanied evacuation (when victim doesn't require monitoring or for a free-hanging evacuation):

1. Victim suspended by a lanyard, with the energy absorber torn by the fall
2. Hauling (allows the victim to be released)
3. Lowering the victim

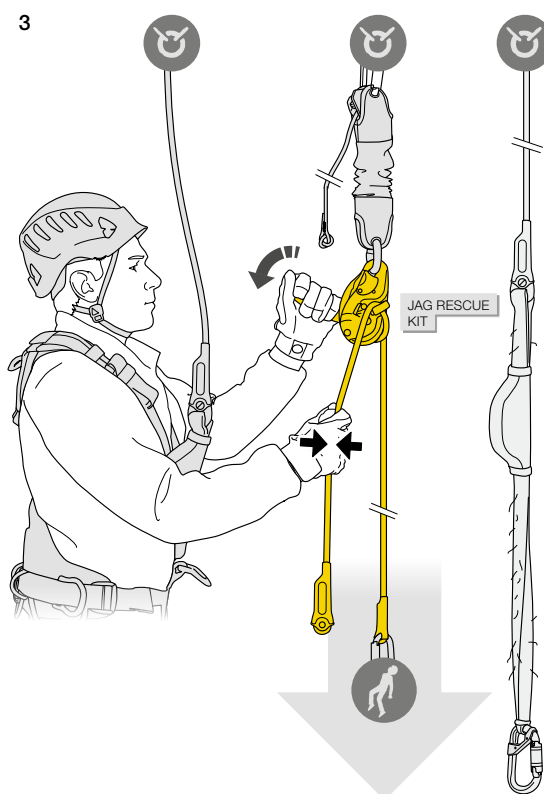
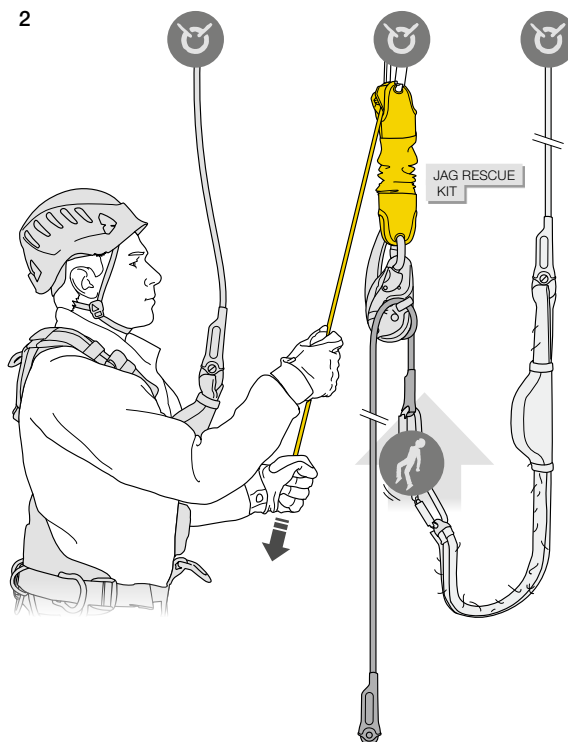
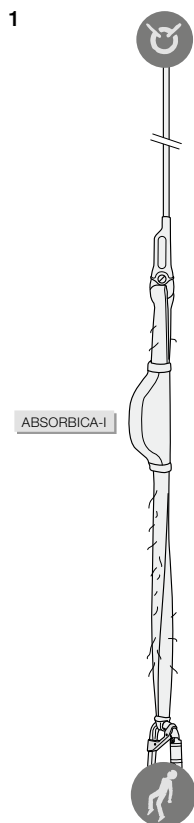

To learn more about using the JAG RESCUE KIT to rescue a victim, see the technical information available at www.petzl.com

PETZL.COM



For more information, see technical tips at www.petzl.com

PETZL.COM

TECHNICAL RESCUE

Technical rescue training with GRIMP 30, Nîmes, France © 2020 - Petzl Distribution - Vuedici.org - GRIMP 30 - VATEL



SPIN L1 and SPIN L2

SPIN L1 and SPIN L2 are very high efficiency pulleys with swivel. Openable even when attached to the anchor, these pulleys are designed for maximum simplicity in setting up hauling systems or Tyrolean systems, and in the case of SPIN L1, load deviation systems as well. The large-diameter sheaves mounted on sealed ball bearings provide excellent efficiency. The swivel facilitates handling, allowing the pulley to be oriented under load and to directly connect carabiners, ropes or slings.



Technical rescue teams respond when the situation is especially difficult and requires significant resources to be deployed.

Examples of rescues:

- following a vehicle roll-over into a ravine, the victims are rescued via motorized means
- evacuation of an injured worker from a location that is difficult to access
- helicopter rescue operations in mountainous terrain...

Technical specifics:

- technical rescue teams operate in any terrain. They have complete mastery of all progression and belay techniques on a rope
- when the terrain allows, downward evacuation is preferred because of the gravity-assist
- upward evacuation is a team effort that requires perfect coordination by everyone involved. It demands techniques which are sometimes particularly complex: raising systems, creating a haul system using lightweight pulleys, counterweight techniques...

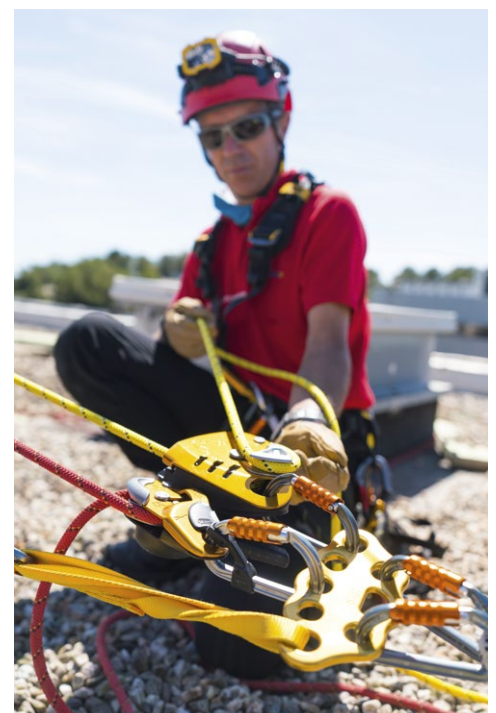

Using the MAESTRO

The MAESTRO enables controlled lowering of loads up to 250 kg (MAESTRO S) and 280 kg (MAESTRO L).

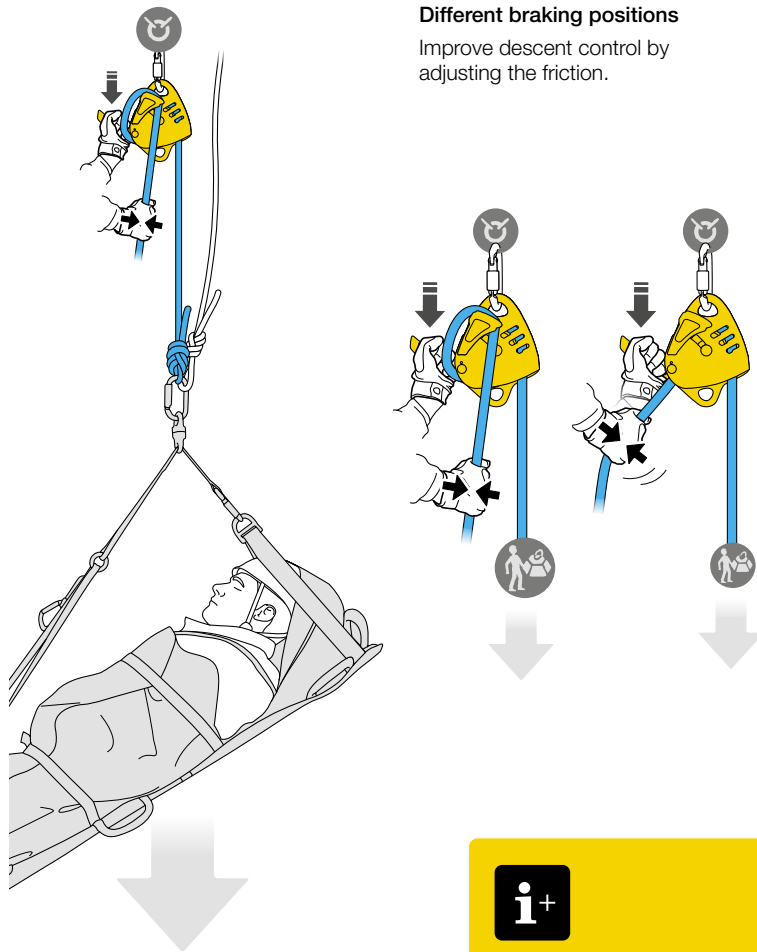

Different braking positions

Improve descent control by adjusting the friction.

AUTO-LOCK

The AUTO-LOCK system locks the load automatically and returns the handle to the stop position.

The user may then let go of the rope if needed.



AUTO-LOCK SYSTEM

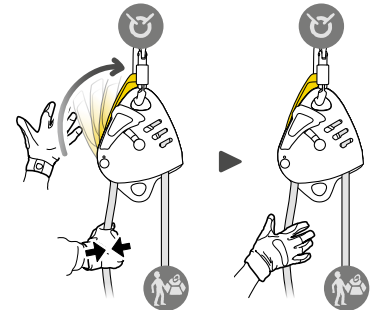

Hauling is possible at any time, without manipulating the handle.

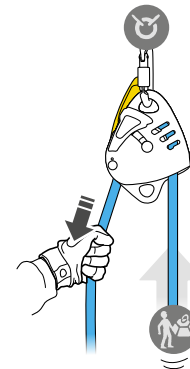

To learn more about MAESTRO performance, see the technical information for hauling and lowering at www.petzl.com

PETZL.COM

Rope redirect with SPIN L1D pulley

Rope redirect when raising:
sheave rotates in the direction of the ascent.

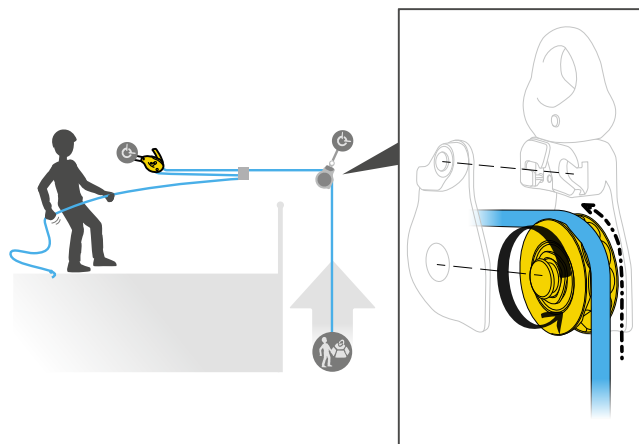

Extra friction makes for a more comfortable descent:
the sheave does not rotate, and the facets provide additional friction on the rope.

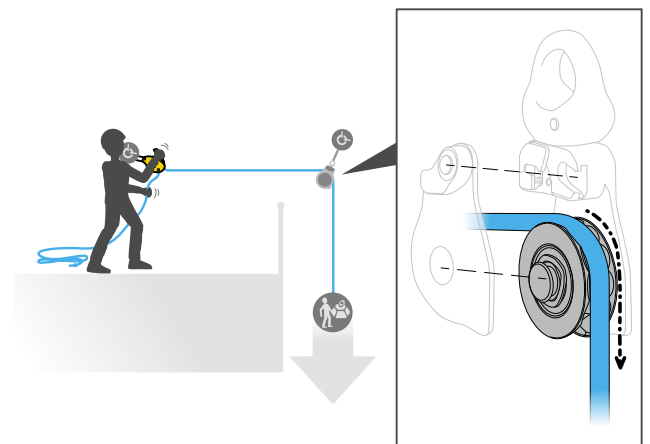

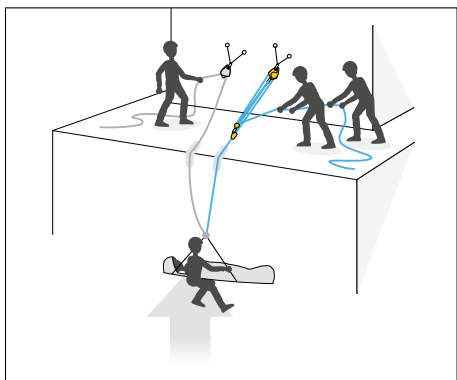

Upward evacuation with a haul line and a belay line

The haul line supports the entire load.
No slack is allowed in the belay rope, so that the load locks instantly in the event of haul line failure.

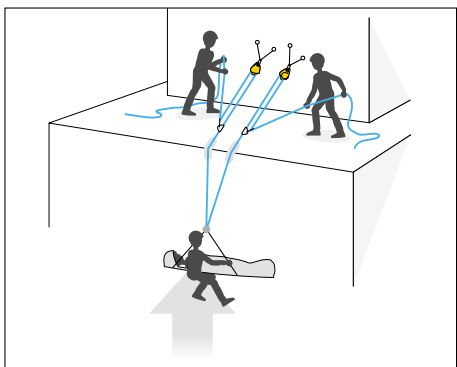
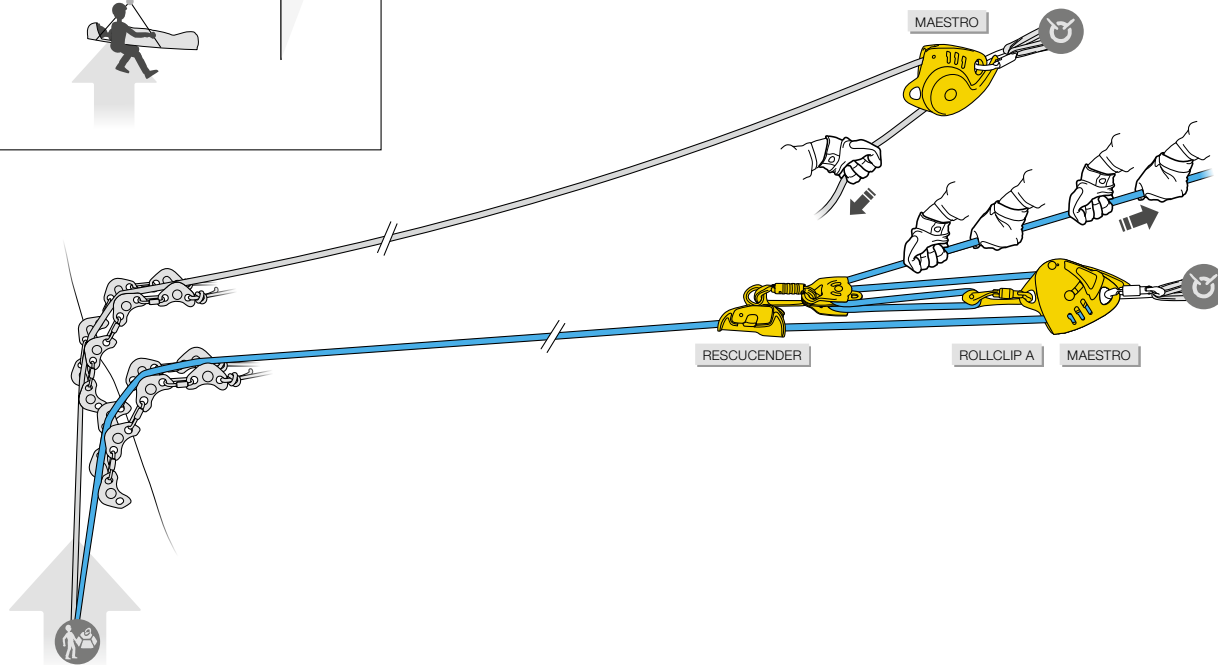

Upward evacuation with two haul lines

Each rope supports half the load.
The MAESTRO's excellent pulley efficiency allows the operation to be carried out using simple haul systems (3:1).

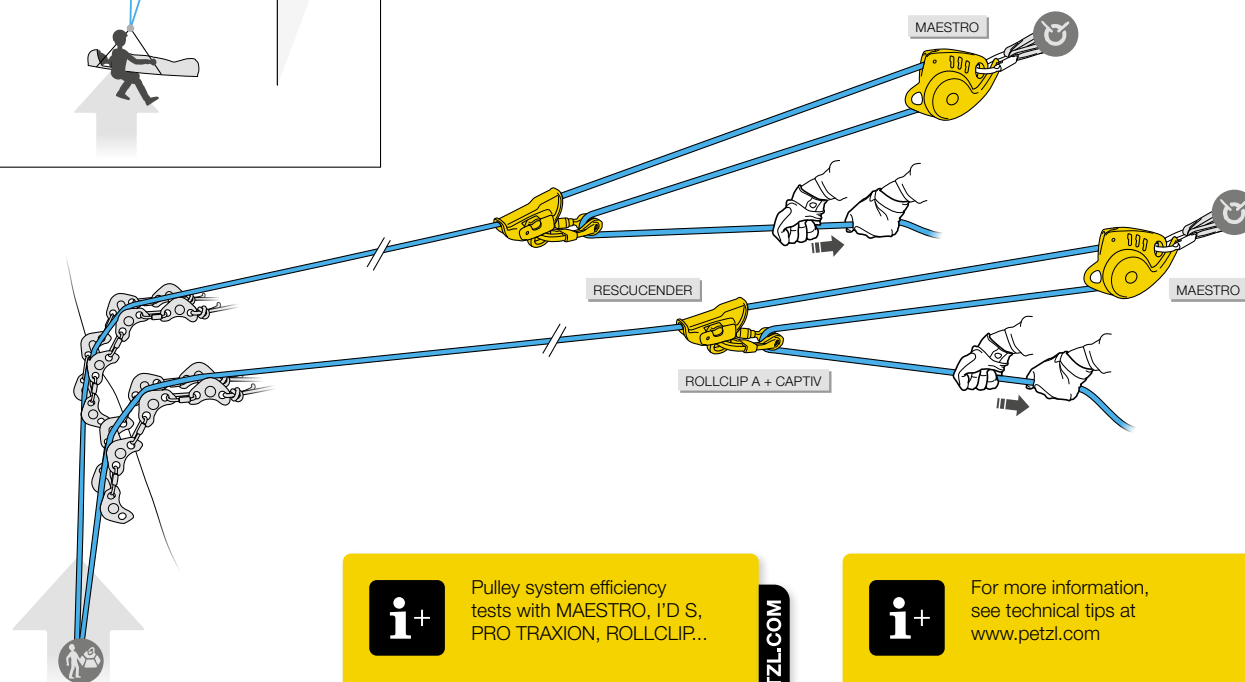

Pulley system efficiency tests with MAESTRO, I'D S., PRO TRAXION, ROLLCLIP...

PETZL.COM



For more information, see technical tips at www.petzl.com

PETZL.COM

SKI LIFT EVACUATION

If ski lift equipment fails, the person in charge must evacuate passengers according to the evacuation plan. This evacuation must be done within a predefined time frame, and is generally conducted by the operations staff.

Technical specifics:

- accessing the passengers is done by moving along the cable, from the towers
- these operations are managed simultaneously by multiple autonomous teams, generally made up of:
 - a person suspended on the cable who evacuates passengers and whose movements are protected by a team member on the tower
 - a person on the ground who receives passengers and guides the movement of the team member on the cable
- the success of these operations hinges largely on the instruction, training and practice of the operations staff (at least once a year)





Evacuation exercise on the gondola lift in La Grave, France © 2020 - Petzl Distribution - Vuedici.org - SATG

ABSORBICA-Y 150 MGO international version

ABSORBICA-Y MGO 150 is a double lanyard with compact energy absorber, designed for progression on a vertical structure or a lifeline, and when passing intermediate anchors. The arms are elasticized to avoid hindering progression. It is equipped with two MGO large-opening connectors.

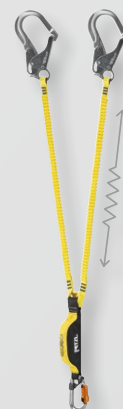

Ski lift evacuation

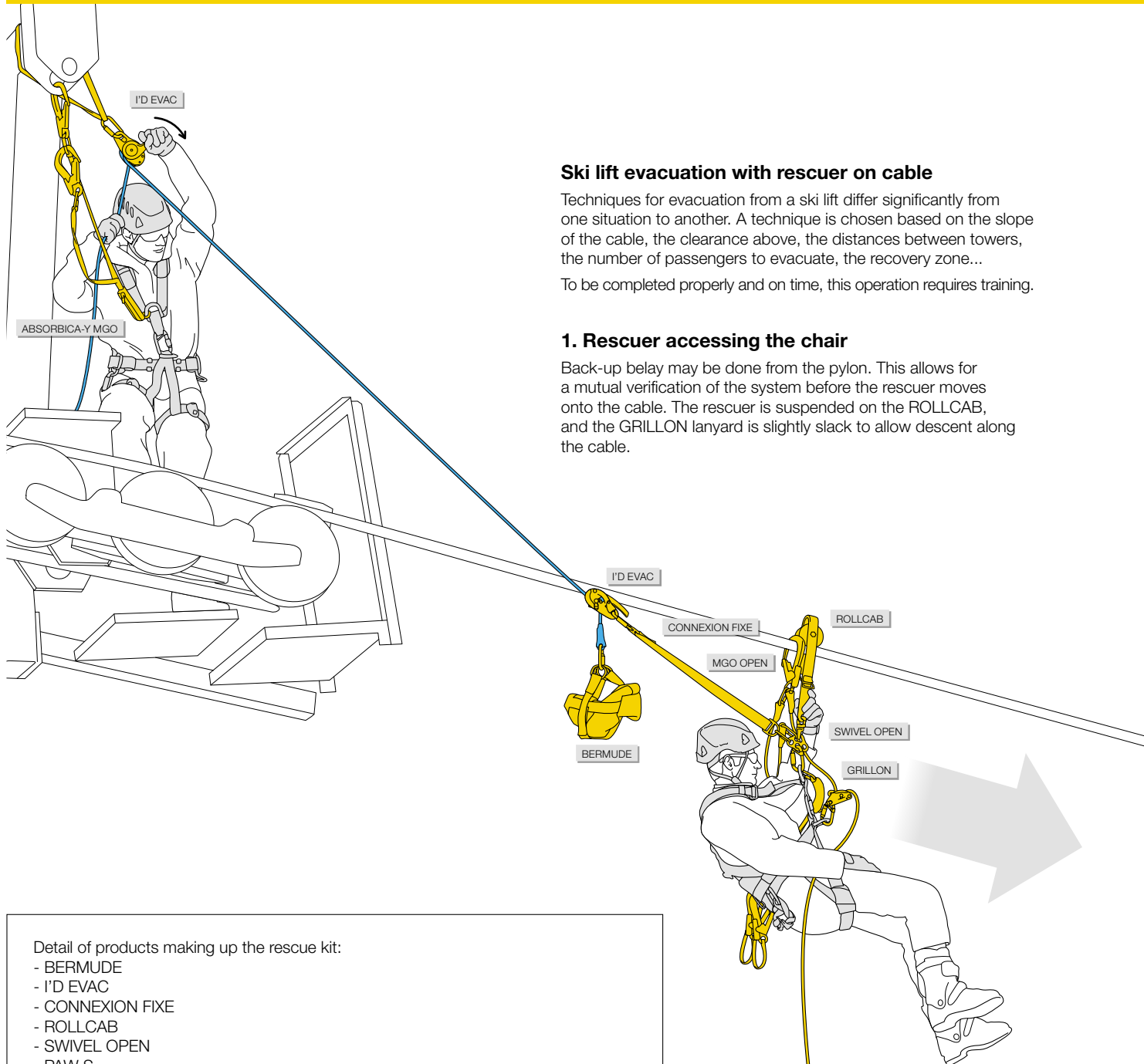

Ski lift evacuation with rescuer on cable

Techniques for evacuation from a ski lift differ significantly from one situation to another. A technique is chosen based on the slope of the cable, the clearance above, the distances between towers, the number of passengers to evacuate, the recovery zone...

To be completed properly and on time, this operation requires training.

1. Rescuer accessing the chair

Back-up belay may be done from the pylon. This allows for a mutual verification of the system before the rescuer moves onto the cable. The rescuer is suspended on the ROLLCAB, and the GRILLON lanyard is slightly slack to allow descent along the cable.

Detail of products making up the rescue kit:

- BERMUDE
- I'D EVAC
- CONNEXION FIXE
- ROLLCAB
- SWIVEL OPEN
- PAW S
- JANE
- GRILLON
- MGO OPEN
- GO x 4
- Am'D x 4
- CAPTIV x 3
- AXIS 11 mm with sewn termination

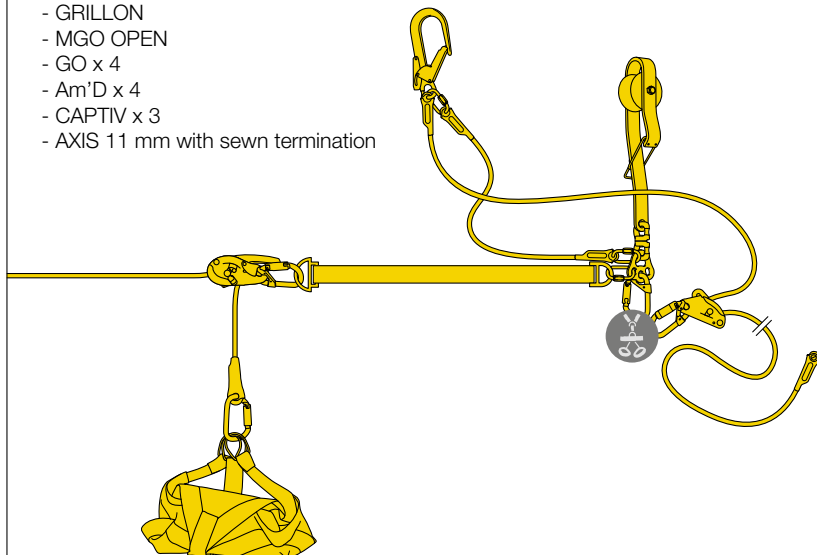

2. Evacuating the passenger

The rescuer descends on the GRILLON lanyard to the chair. S/he installs the BERMUDE rescue triangle on the victim, then evacuates the victim with an I'D EVAC descender.

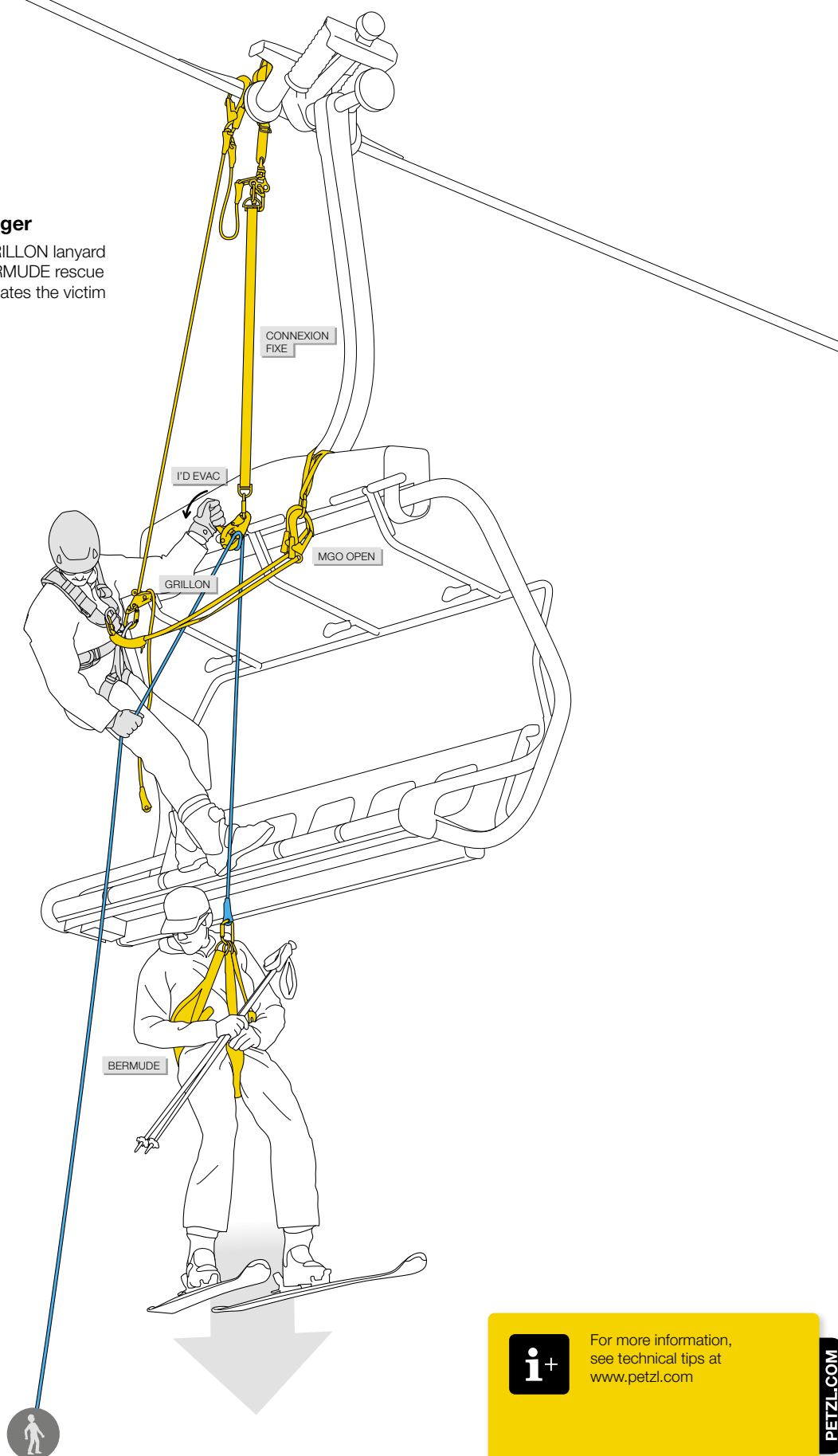

For more information,
see technical tips at
www.petzl.com

PETZL.COM

HARNESSES

Simple to use, comfortable, with numerous accessories and technically suited to the requirements of the work they are designed for, Petzl harnesses set the standard in terms of safety and efficiency for workers at height.



Working from an aerial work platform; Bourg-en-Bresse, France © 2020 Petzl Distribution - Lafouche - LOCNACELLE

To give each user the best possible fit, Petzl harnesses are adjustable at the waist, shoulders and leg loops. They are equipped with different types of buckles:



Automatic buckles
Automatic buckles are opened and closed simply and quickly, even when wearing gloves, without loss of adjustment.



Self-locking buckles
These buckles do not require re-threading to be locked: they adjust easily in seconds.



General purpose harnesses

Fall-arrest harnesses

Fall-arrest harnesses with a simple, lightweight design.



NEW 2021



NEWTON

NEW 2021



NEWTON FAST

NEW 2021



NEWTON EASYFIT

Fall-arrest and work positioning harnesses

Fall-arrest and work positioning harnesses that are comfortable and easily donned.



VOLT



VOLT WIND

Harnesses for fall-arrest, work positioning and suspension

Versatile and very comfortable harnesses for fall-arrest, work positioning and suspension.



AVAO BOD
AVAO BOD FAST



AVAO SIT / AVAO SIT FAST



TOP

Specialized harnesses

Rope access harnesses

Very comfortable harnesses, with integrated ventral rope clamp to facilitate ascending a rope.



ASTRO BOD FAST



ASTRO SIT FAST



TOP CROLL S



TOP CROLL L

Tree care harnesses

Very comfortable harnesses, with attachment bridge for greater freedom of movement in the trees.



SEQUOIA SRT



SEQUOIA

Rescue harnesses

Lightweight harnesses suitable for various rescue environments.



FALCON



FALCON ASCENT



FALCON MOUNTAIN

Litter and evacuation triangles

Equipment designed for rope rescue (confined spaces, ski lifts...).



NEST



PITAGOR



BERMUDE

Fall-arrest harnesses, European version

Certified to European and Russian standards, these harnesses are designed specifically for fall arrest. More specifically, they allow for the attachment of ABSORBICA energy-absorbing lanyards or an ASAP or ASAP LOCK mobile fall arrester.

• Lightweight, ergonomic design

NEWTON harnesses are designed to avoid interfering with workers' movements. The anatomical and lightweight design is close-fitting yet allows optimal freedom of movement.

• Easy to use



Harness is easy to open and close

The FAST LT PLUS sternal automatic buckle allows the harness to be fastened and unfastened quickly and easily, without loss of adjustment, even with gloves. The locking system of the buckle limits the risk of accidental unfastening.



Ready access to tools

The equipment loops simplify tool organization, and the slots allow a TOOLBAG pouch to be added.

• Versatile



Textile sternal attachment point

Lightweight and abrasion-resistant, the textile sternal attachment point allows attachment of a fall-arrest system.



Metal dorsal attachment point

Made of anodized aluminum for high strength, the dorsal attachment point allows attachment of a fall-arrest system.

• Great simplicity



NEWTON harnesses have color-coded (yellow/black) straps allowing rapid identification of the upper and lower parts of the harness before donning.

• Quick donning



Equipped with padded shoulder straps and FAST LT automatic buckles on the leg loops, the NEWTON FAST harness dons very easily with both feet on the ground, without loss of adjustment.

• Optimal comfort



The NEWTON EASYFIT harness is designed to keep its shape, and includes two pockets for stowing small items. The leg loops are padded and equipped with FAST LT automatic buckles, enabling the harness to be easily donned while keeping both feet on the ground, without loss of adjustment.



NEW
2021



NEWTON European version

Fall-arrest harness

NEWTON is a lightweight, ergonomic fall-arrest harness. It is easy to use and its straps are color-coded to simplify donning. The harness allows immediate access to tools, thanks to its equipment loops and slots for the TOOLBAG pouch. Its textile sternal attachment point and metal dorsal attachment point provide tremendous versatility. It is certified to European and Russian standards.

NEW
2021



NEWTON FAST European version

Quick-donning fall-arrest harness

NEWTON FAST is a lightweight, ergonomic fall-arrest harness that can be quickly donned. It is equipped with padded shoulder straps and FAST LT automatic buckles on the leg loops, allowing the harness to be donned with both feet on the ground, without loss of adjustment. The harness allows immediate access to tools, thanks to its equipment loops and slots for the TOOLBAG pouch. Its textile sternal attachment point and metal dorsal attachment point provide tremendous versatility. It is certified to European and Russian standards.

NEW
2021



NEWTON EASYFIT European version

Comfortable and quick-donning fall-arrest harness

NEWTON EASYFIT is a comfortable, ergonomic fall-arrest harness that can be quickly donned. It is equipped with padded shoulder straps and FAST LT automatic buckles on the leg loops, allowing the harness to be donned with both feet on the ground, without loss of adjustment. Its lightweight, breathable design offers two zippered pockets for stowing small items. The harness allows immediate access to tools, thanks to its equipment loops and slots for the TOOLBAG pouch. Its textile sternal attachment point and metal dorsal attachment point provide tremendous versatility. It is certified to European and Russian standards.

Accessories

NEW
2021



HI-VIZ vest for NEWTON harnesses

Fluorescent-colored vest with reflective strips makes the worker highly visible in all lighting conditions. It installs quickly and easily on NEWTON, NEWTON FAST and NEWTON EASYFIT harnesses. The sternal buckle, the multiple attachment points and the connector-holders all remain accessible during use, for optimal freedom of movement.

NEW
2021



Leg loop padding for NEWTON harnesses

Leg loop padding for increased comfort with the NEWTON and NEWTON FAST harnesses, or for replacing the padding on NEWTON EASYFIT harnesses.

Certified to North American, European and Russian standards, these harnesses are designed specifically for fall arrest. More specifically, they allow for the attachment of ABSORBICA energy-absorbing lanyards or an ASAP or ASAP LOCK mobile fall arrester.

- **Lightweight, ergonomic design**

NEWTON harnesses are designed to avoid interfering with workers' movements. The anatomical and lightweight design is close-fitting yet allows optimal freedom of movement.

- **Easy to use**



- **Harness is easy to open and close**

The FAST LT PLUS sternal automatic buckle allows the harness to be fastened and unfastened quickly and easily, without loss of adjustment, even with gloves. The locking system of the buckle limits the risk of accidental unfastening.



- **Stowage for lanyard connectors**

The harnesses have a stowage system for fall-arrest lanyard connectors on each shoulder strap. In the event of a fall, the system releases the MGO connector and allows the absorber to be deployed.

- **Versatile**

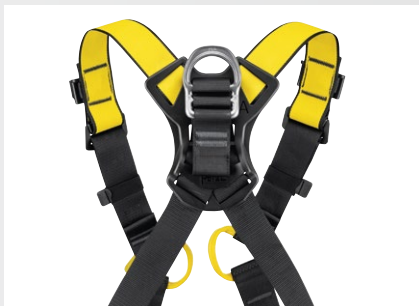

The harnesses have a metal dorsal attachment point that allows attachment of a fall-arrest system, and a textile dorsal attachment point that allows attachment of a self-retracting fall-arrest system.

- **Easy harness inspection**



The sternal and dorsal attachment points are equipped with fall indicators: a red strap appears after a fall to indicate that the harness must be retired.

- **Great simplicity**



NEWTON harnesses have color-coded (yellow/black) straps allowing rapid identification of the upper and lower parts of the harness before donning.

- **Quick donning**



Equipped with padded shoulder straps and FAST LT PLUS automatic buckles on the leg loops, the NEWTON harness dons very easily with both feet on the ground, without loss of adjustment.

- **Optimal comfort**



The NEWTON EASYFIT harness is designed to keep its shape, and includes two pockets for stowing small items. The leg loops are padded and equipped with FAST LT PLUS automatic buckles, enabling the harness to be easily donned while keeping both feet on the ground, without loss of adjustment.



NEW
2021



NEWTON International version

Fall-arrest harness

NEWTON is a lightweight, ergonomic fall-arrest harness. It is easy to use and its straps are color-coded to simplify donning. The harness allows immediate access to tools, thanks to its equipment loops and slots for the TOOLBAG pouch. Its textile sternal attachment point and metal and textile dorsal attachment points provide tremendous versatility. It offers ergonomic stowage of MGO connectors and has fall indicators. It is certified to North American, European and Russian standards.

NEW
2021



NEWTON FAST International version

Quick-donning fall-arrest harness

NEWTON FAST is a lightweight, ergonomic fall-arrest harness that can be quickly donned. It is equipped with padded shoulder straps and FAST LT PLUS automatic buckles on the leg loops, allowing the harness to be donned with both feet on the ground, without loss of adjustment. The harness allows immediate access to tools, thanks to its equipment loops and slots for the TOOLBAG pouch. Its textile sternal attachment point and metal and textile dorsal attachment points provide tremendous versatility. It offers ergonomic stowage of MGO connectors and has fall indicators. It is certified to North American, European and Russian standards.

NEW
2021



NEWTON EASYFIT International version

Comfortable and quick-donning fall-arrest harness

NEWTON EASYFIT is a comfortable, ergonomic fall-arrest harness that can be quickly donned. It is equipped with padded shoulder straps and FAST LT PLUS automatic buckles on the leg loops, allowing the harness to be donned with both feet on the ground, without loss of adjustment. Its lightweight, breathable design offers two zippered pockets for stowing small items. The harness allows immediate access to tools, thanks to its equipment loops and slots for the TOOLBAG pouch. Its textile sternal attachment point and metal and textile dorsal attachment points provide tremendous versatility. It offers ergonomic stowage of MGO connectors and has fall indicators. It is certified to North American, European and Russian standards.

Accessories

NEW
2021



HI-VIZ vest for NEWTON harnesses

Fluorescent-colored vest with reflective strips makes the worker highly visible in all lighting conditions. It installs quickly and easily on NEWTON, NEWTON FAST and NEWTON EASYFIT harnesses. The sternal buckle, the multiple attachment points and the connector-holders all remain accessible during use, for optimal freedom of movement.

NEW
2021



Leg loop padding for NEWTON harnesses

Leg loop padding for increased comfort with the NEWTON and NEWTON FAST harnesses, or for replacing the padding on NEWTON EASYFIT harnesses.

Fall-arrest and work positioning harnesses

These harnesses help provide fall protection for the worker and enable him/her to position him/herself at a workstation, with a GRILLON lanyard, for example. Additionally, they are specifically designed to facilitate vertical progression on a rail or cable (European versions only).

• Quick and easy donning



VOLT and VOLT WIND harnesses are very quick to don. The waistbelt and leg loops are equipped with FAST LT PLUS / FAST LT automatic buckles, allowing the harness to be easily donned while keeping both feet on the ground.

• Optimal comfort



Comfortable work positioning

Wide, semi-rigid waistbelt and leg loops give excellent support. The lightweight, breathable construction maximizes air flow.

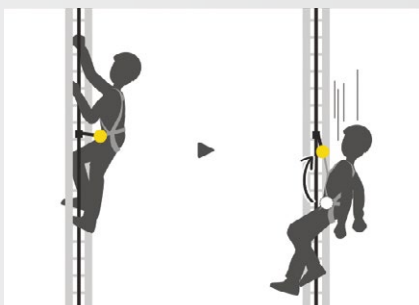

Ventral attachment point suitable for vertical progression on a rail or cable

The LADDER CLIMB attachment point allows for ventral attachment of the fall-arrest trolley, which distributes the load on the waistbelt and thus ensures optimal comfort. In the event of a fall, the attachment point automatically moves upward to a sternal position to ensure a vertical post-fall body position (only on European versions).

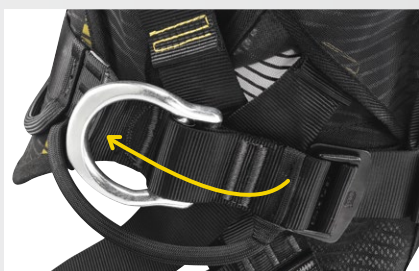

Folding side attachment points

Side attachment points can be folded down to prevent them snagging accidentally when not in use.

• Easy to use

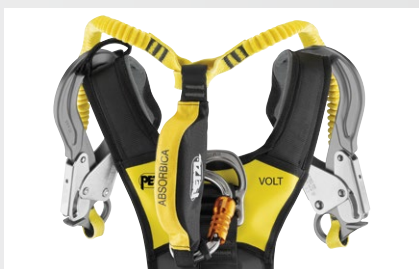

The harnesses have a stowage system for the MGO connectors on fall-arrest lanyards on each shoulder strap. In the event of a fall, the system releases the MGO connectors and allows the absorber to be deployed.

• For work on towers and antennas



VOLT harnesses have a wide waistbelt with equipment loops on the back for easy organization of work tools.

• For work inside wind turbine towers



VOLT WIND harnesses have dorsal wear protectors to reduce wear on the straps when moving about inside a wind turbine tower.



VOLT® European version

Fall-arrest and work positioning harness with attachment point for vertical progression on rail or cable

The VOLT fall-arrest and work positioning harness is very quick to don, thanks to the FAST LT PLUS and FAST LT automatic buckles that allow it to be donned with both feet on the ground. The wide, semi-rigid waistbelt and leg loops give excellent support. Its lightweight, breathable construction maximizes air flow. Its LADDER CLIMB attachment point allows for ventral attachment of the fall-arrest trolley, ensuring optimal comfort during progression. It is certified to European and Russian standards.



VOLT® international version

Fall-arrest and work positioning harnesses

The VOLT fall-arrest and work positioning harness is very quick to put on, thanks to the FAST LT PLUS automatic buckles that allow it to be donned with both feet on the ground. The wide, semi-rigid waistbelt and leg loops give excellent support. Its lightweight, breathable construction maximizes air flow. It features a textile dorsal attachment point designed for connecting a self-retracting fall-arrest system. It is certified to U.S. and European standards.



VOLT® WIND European version

Fall-arrest and work positioning harness for the wind power industry with attachment point for vertical progression on rail or cable

The VOLT WIND fall-arrest and work positioning harness is very quick to put on, thanks to the FAST LT PLUS and FAST LT automatic buckles that allow it to be donned while keeping both feet on the ground. The wide, semi-rigid waistbelt and leg loops give excellent support. Its lightweight, breathable construction maximizes air flow. Its LADDER CLIMB attachment point allows for ventral attachment of the fall-arrest trolley, ensuring optimal comfort during progression. It has wear protectors on the waistbelt and dorsal point to limit wear when moving about inside the wind turbine tower. It is certified to European and Russian standards.



VOLT® WIND international version

Fall-arrest and work positioning harness for the wind power industry

The VOLT WIND fall-arrest and work positioning harness is very quick to put on, thanks to the FAST LT PLUS automatic buckles that allow it to be donned while keeping both feet on the ground. The wide, semi-rigid waistbelt and leg loops give excellent support. Its lightweight, breathable construction maximizes air flow. It features a textile dorsal attachment point designed for connecting a self-retracting fall-arrest system. It has wear protectors on the waistbelt and dorsal point to limit wear when moving about inside the wind turbine tower. It is certified to U.S. and European standards.



Accessory



Seat for VOLT® harnesses

Seat for VOLT harnesses for greater comfort during suspension

The seat for the VOLT harness attaches to the designated slots on the harness. It provides additional comfort during prolonged suspension.



Harnesses for fall arrest, work positioning and suspension

These harnesses are used for fall protection, for positioning at a workstation, and for working comfortably in suspension.

• Comfortable construction



Wide, semi-rigid waistbelt and leg loops give excellent support. The lightweight, breathable construction maximizes air flow.

• Convenient adjustment



Easy to adjust

The AVAO harnesses can be adjusted at the waistbelt and shoulder straps. These adjustment points are equipped with self-locking DOUBLEBACK buckles. These do not require re-threading to be locked: the harness adjusts easily in seconds.



Available in easier donning version

The leg loops of AVAO harnesses are equipped with FAST / FAST LT automatic buckles that facilitate donning the harness with both feet on the ground or with large footwear, without loss of adjustment, even when wearing gloves.

• Optimal organization of work tools



AVAO harnesses are equipped with six equipment loops on the sides and at the rear of the waistbelt. They are shaped to facilitate clipping carabiners. Each harness also has slots designed for the CARITOOL tool holder and the TOOLBAG pouch.

• Stowage for lanyard connectors

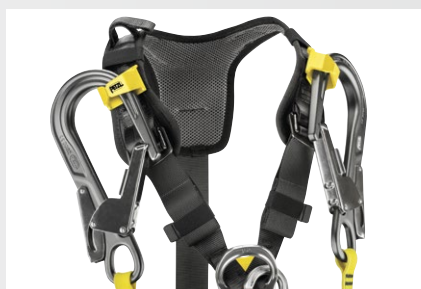

The harnesses have a stowage system for fall-arrest lanyard connectors on each shoulder strap. In the event of a fall, the system releases the MGO connector and allows the absorber to be deployed.

• A complete solution, with dorsal attachment point



The AVAO BOD and AVAO BOD FAST full-body harnesses are equipped with a dorsal attachment point for connecting a fall-arrest system. In the event of a fall on this attachment point, a shorter adjustment of the length between the waistbelt and the leg loops means the load is taken up on the leg loops, allowing the user to remain suspended longer while awaiting rescue.

• A lightweight and flexible solution

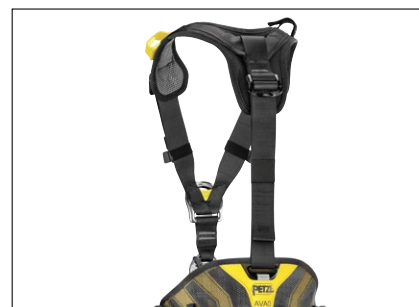

Combining a seat harness with a separate chest harness is a more lightweight solution, if the user does not need a dorsal attachment point. It is also a solution for hard-to-fit body types, as it allows users to combine different seat and chest harness sizes.



AVAO® BOD / AVAO® BOD FAST European version Comfortable harness for fall arrest, work positioning and suspension

The AVAO BOD fall arrest, work positioning and suspension harness is designed for greater comfort in all situations. The wide, semi-rigid waistbelt and leg loops give excellent support. Its lightweight, breathable construction maximizes air flow. The shoulder straps have a system for stowing the fall-arrest lanyard connectors and keeping them within reach. The DOUBLEBACK self-locking buckles at the rear of the harness, between the waistbelt and the leg loops, allow for a shorter adjustment when the dorsal attachment point is used. The harness also facilitates the carrying and organizing of work tools, with multiple gear loops and slots for attaching CARITool tool holders and TOOLBAG tool-holder pouches. The harness is fastened by a SCREW-LOCK manual locking carabiner and is certified to European and Russian standards. AVAO BOD features leg loops with DOUBLEBACK self-locking buckles; AVAO BOD FAST has leg loops with FAST LT automatic buckles.



AVAO® BOD / AVAO® BOD FAST international version Comfortable harness for fall arrest, work positioning and suspension

The AVAO BOD fall arrest, work positioning and suspension harness is designed for greater comfort in all situations. The wide, semi-rigid waistbelt and leg loops give excellent support. Its lightweight, breathable construction maximizes air flow. The shoulder straps have a system for stowing the fall-arrest lanyard connectors and keeping them within reach. The DOUBLEBACK self-locking buckles at the rear of the harness, between the waistbelt and the leg loops, allow for a shorter adjustment when the dorsal attachment point is used. The harness also facilitates the carrying and organizing of work tools, with multiple gear loops and slots for attaching CARITool tool holders and TOOLBAG tool-holder pouches. The harness has an integrated fall indicator on the dorsal attachment point and is fastened with a TRIACT-LOCK automatic locking carabiner. It is certified to North American and European standards. AVAO BOD features leg loops with DOUBLEBACK self-locking buckles; AVAO BOD FAST has leg loops with FAST automatic buckles.



TOP Chest harness for seat harness

The TOP chest harness transforms AVAO SIT, AVAO SIT FAST, FALCON, FALCON MOUNTAIN and SEQUOIA SRT seat harnesses into fall-arrest harnesses. The padded shoulder straps are widely spaced to reduce neck chafing. When the waistbelt is loaded, they help distribute the load over the shoulders. They also have a system for stowing the fall-arrest lanyard connectors and keeping them within reach.



AVAO® SIT / AVAO® SIT FAST Comfortable seat harness for work positioning and suspension

The AVAO SIT work positioning and suspension seat harness is designed for greater comfort in a variety of situations. The wide, semi-rigid waistbelt and leg loops give excellent support. Its lightweight, breathable construction maximizes air flow. The harness also facilitates the carrying and organizing of work tools, with multiple gear loops and slots for attaching CARITool tool holders and TOOLBAG tool-holder pouches. This seat harness is designed to be converted into a fall-arrest harness when combined with a TOP chest harness, or into a rope access harness when combined with a TOP CROLL S or L chest harness. The AVAO SIT leg loops have DOUBLEBACK self-locking buckles; AVAO SIT FAST leg loops have FAST LT automatic buckles.



Rope access harnesses

Designed for rope access, these harnesses allow the worker to be protected in the event of a fall and to position him/herself at the workstation. The gated ventral attachment point facilitates rope ascents and makes work in suspension more comfortable.

• Optimal integration of equipment



The gated attachment point allows connection of:

- a CROLL ventral rope clamp on the ventral point for greater efficiency on rope ascents
- a PROGRESS lanyard directly on the ventral attachment point
- a PODIUM seat on the axle of the attachment point, allowing the load to be supported directly by the descender, while guaranteeing mobility at the ventral attachment point

• Optimal organization of work tools



ASTRO harnesses are equipped with six equipment loops on the sides and at the rear of the waistbelt. They are shaped to facilitate clipping carabiners. Each harness also has slots designed for the CARITOOL tool holder and the TOOLBAG pouch.

• Ultra-comfortable design



The waistbelt and the leg loops of ASTRO harnesses are semi-rigid and wide in order to limit pressure points and ensure effective support. These two zones are sculpted and lined with breathable foam padding for optimal comfort in suspension, and for good ventilation. This construction also facilitates harness donning.

• Convenient adjustment



Easy to don

The leg loops of ASTRO harnesses are equipped with FAST / FAST LT automatic buckles that facilitate donning the harness with both feet on the ground or with large footwear, without loss of adjustment, even when wearing gloves.



Easy to adjust

The waistbelt and shoulder straps are equipped with self-locking DOUBLEBACK / DOUBLEBACK PLUS buckles for quick and easy adjustment.

• A complete solution, with dorsal attachment point



ASTRO BOD FAST full-body harnesses are equipped with a dorsal attachment point for attaching a fall-arrest system. In the event of a fall on this attachment point, a shorter adjustment of the length between the waistbelt and the leg loops means the load is taken up on the leg loops, allowing the user to remain suspended longer while awaiting rescue.

• A lightweight and flexible solution



Combining a seat harness with a separate chest harness is a more lightweight solution, if the user does not need a dorsal attachment point. It is also a solution for hard-to-fit body types, as it allows users to combine different seat and chest harness sizes.



ASTRO® BOD FAST European version

Ultra-comfortable rope access harness

With an integrated CROLL L ventral rope clamp, the ASTRO BOD FAST harness is designed for greater efficiency and comfort during rope ascents. The gated ventral attachment point allows optimal integration of equipment (rope clamp, lanyard, seat...). The wide, semi-rigid waistbelt and leg loops give excellent support. They are contoured and lined with breathable foam padding for comfort when suspended. The DOUBLEBACK self-locking buckles at the rear of the harness, between the waistbelt and the leg loops, allow for a shorter adjustment when the dorsal attachment point is used. The harness also facilitates the carrying and organizing of work tools, with multiple gear loops and slots for attaching CARITool tool holders and TOOLBAG tool-holder pouches. It is certified to European and Russian standards. The ASTRO BOD FAST (European version) features leg loops with FAST LT automatic buckles.



ASTRO® BOD FAST international version

Ultra-comfortable rope access harness

With an integrated CROLL L ventral rope clamp, the ASTRO BOD FAST harness is designed for greater efficiency and comfort during rope ascents. The gated ventral attachment point allows optimal integration of equipment (rope clamp, seat...). The wide, semi-rigid waistbelt and leg loops give excellent support. They are contoured and lined with breathable foam padding for comfort when suspended. The DOUBLEBACK self-locking buckles at the rear of the harness, between the waistbelt and the leg loops, allow for a shorter adjustment when the dorsal attachment point is used. The harness also facilitates the carrying and organizing of work tools, with multiple gear loops and slots for attaching CARITool tool holders and TOOLBAG tool-holder pouches. It has a fall indicator on the dorsal attachment point and is certified to North American and European standards. ASTRO BOD FAST (international version) features leg loops with FAST automatic buckles.



TOP CROLL® S

Chest harness for seat harness, with integrated CROLL S ventral rope clamp

The TOP CROLL S integrates a CROLL S ventral rope clamp to transform ASTRO SIT FAST, AVAO SIT, AVAO SIT FAST, FALCON, FALCON ASCENT and SEQUOIA SRT harnesses into rope access harnesses. The textile sternal attachment point optimally reduces weight and bulk. The padded shoulder straps are widely spaced to reduce neck chafing. When the waistbelt is loaded, they help distribute the load over the shoulders. The rear connection, on each side of the waistbelt, offers excellent stability.



TOP CROLL® L

Chest harness for seat harness, with integrated CROLL L ventral rope clamp

The TOP CROLL L integrates a CROLL L ventral rope clamp to transform ASTRO SIT FAST, AVAO SIT, AVAO SIT FAST, FALCON, FALCON ASCENT and SEQUOIA SRT harnesses into rope access harnesses. The padded shoulder straps are widely spaced to reduce neck chafing. When the waistbelt is loaded, they help distribute the load over the shoulders.



ASTRO® SIT FAST

Ultra-comfortable seat harness for rope access

The ASTRO SIT FAST rope access seat harness features a gated ventral attachment point that allows optimal integration of equipment (rope clamp, lanyard, seat...). The wide, semi-rigid waistbelt and leg loops give excellent support. They are contoured and lined with breathable foam padding for comfort when suspended. The harness also facilitates the carrying and organizing of work tools, with multiple gear loops and slots for attaching CARITool tool holders and TOOLBAG tool-holder pouches. This seat harness is designed to be converted into a full-body harness when combined with a TOP CROLL S or L chest harness. The ASTRO SIT FAST features leg loops with FAST LT automatic buckles.



Accessory



PODIUM

Seat for prolonged suspension

The PODIUM provides optimal comfort during prolonged suspension. The wide seat offers excellent stability. Rigid sides prevent the webbing straps from cutting into the thighs. The easy-to-use seat has two gear loops and a rear hook, making it easier to store in order to facilitate movement. It connects to ASTRO BOD FAST and ASTRO SIT FAST harnesses with two shackles (find a description of the shackles on page 65).



These harnesses are designed for arborists: they ensure great mobility in the tree and optimally distribute the load between the waistbelt and the leg loops. They also provide excellent lumbar support in the many work phases where the arborist has his/her weight on the harness.

• Comfort



The semi-rigid, extra-wide waistbelt ensures excellent support for the user. It is also sculpted and lined with foam padding for improved comfort when suspended.

• Ergonomics



Gated attachment points

The gated attachment points facilitate connection of a ZILLON or MICROFLIP lanyard. They also allow installation of several attachment bridges (adjustable or fixed), as well as accessories like RING attachment rings or SWIVELS, directly on the attachment bridge.



Easy to don

The leg loops of SEQUOIA harnesses are equipped with FAST / FAST LT automatic buckles that facilitate donning the harness with both feet on the ground or with large footwear, without loss of adjustment, even when wearing gloves.

• Accessories

Accessories for the SEQUOIA line of harnesses allow each user to adapt the equipment to his/her needs.



• For single rope ascent techniques

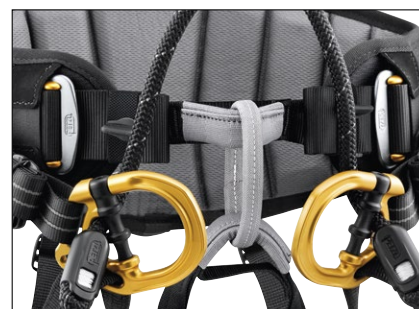

The SEQUOIA SRT features a ventral attachment point for installing a ZIGZAG mechanical Prusik with the CHICANE and KNEE ASCENT accessories.

• For doubled rope ascent techniques



The SEQUOIA harness waistbelt is equipped with a FAST automatic buckle for quick and simple opening and closing, without loss of adjustment, even while wearing gloves.



SEQUOIA SRT

Tree care seat harness for single-rope ascent techniques

The SEQUOIA SRT is a tree care seat harness for single-rope ascent techniques. It has a ventral attachment point that allows a ZIGZAG or ZIGZAG PLUS mechanical Prusik to be installed with the CHICANE and KNEE ASCENT accessories. The extra-wide, semi-rigid waistbelt and leg loops provide comfort for the arborist. It is equipped with DOUBLEBACK PLUS self-locking buckles on the waistbelt and FAST LT PLUS automatic buckles on the leg loops. The gated attachment points allow the user to easily connect a ZILLON or MICROFLIP lanyard, or to install several attachment bridges and accessories directly on the bridge. The harness also facilitates the carrying and organizing of work tools, with multiple equipment loops and slots for attaching CARITool tool holders.



SEQUOIA

Tree care seat harness for doubled-rope ascent techniques

The SEQUOIA is a tree care seat harness for doubled-rope ascent techniques. The extra-wide, semi-rigid waistbelt and leg loops provide comfort for the arborist. The waistbelt is equipped with a FAST automatic buckle for quick and simple opening and closing, without loss of adjustment, even while wearing gloves. The leg loops have FAST LT PLUS automatic buckles. The gated attachment points allow the user to easily connect a ZILLON or MICROFLIP lanyard, or to install several attachment bridges and accessories directly on the bridge. The harness also facilitates the carrying and organizing of work tools, with multiple equipment loops and slots for attaching CARITool tool holders.

Accessories



Shoulder straps (only for SEQUOIA SRT)

Shoulder straps for SEQUOIA SRT seat harness designed for taking the load from the waistbelt and redistributing it to the shoulders for improved comfort. They connect to the ventral attachment point of the harness and to the two slots at the rear of the waistbelt.



Seat

Wide seat for a comfortable working position during suspension. It has an adjustable width to reduce bulk and facilitate movement within the tree. It connects to the two gated points on the SEQUOIA and SEQUOIA SRT arborist seat harnesses, using the two shackles.



Adjustable attachment bridge

Adjustable attachment bridge for SEQUOIA and SEQUOIA SRT harnesses allows quick and precise adjustment of the position of progression tools installed on the bridge.



Attachment bridge

Attachment bridge for connection to the two gated attachment points of the SEQUOIA and SEQUOIA SRT arborist seat harnesses, to optimize lateral mobility.



RING

The RING connection ring can be used to create multiple anchors or be installed directly onto the SEQUOIA and SEQUOIA SRT harnesses' attachment bridges to improve the arborist's lateral mobility.



Shackles

Shackles for connecting a seat.
Find a description of the shackles on page 65.

Rescue harnesses

Designed for rescuers, these harnesses are lightweight, for increased mobility and rapid movement during operations. The choice of several models allows adaptation to the different types of environments that can be encountered.

- **Comfortable, ultra-lightweight design**



- **Thin, lightweight construction**

- The semi-rigid, slim waistbelt and leg loops on FALCON harnesses ensure an optimal comfort/weight ratio.



- **Compact, lightweight side attachment points**

- The textile side attachment points are designed for occasional use and limit bulk and weight.

- **Ergonomics**



- **Easy adjustment**

- The waistbelt and leg loops are equipped with two self-locking DOUBLEBACK buckles for quick and easy adjustment.



- **Movable leg loops**

- The foam on the leg loops of the FALCON harnesses can be adjusted for perfect positioning.

- **Optimal organization of equipment and work tools**



- **Equipment loops and slots**

- FALCON harnesses are equipped with equipment loops on the sides and at the rear of the waistbelt. Each harness also has slots designed for the CARITOOL tool holder and the TOOLBAG pouch.

- **For work in suspension**



The metal ventral attachment point on the FALCON harness distributes the load between the waistbelt and the leg loops during suspension.

- **For efficiency when ascending a rope**



The two-part ventral attachment point of the FALCON ASCENT harness increases the efficiency of rope ascents when using a CROLL ventral rope clamp.

- **For operations using climbing techniques**



The textile bridge construction of the FALCON MOUNTAIN harness favors progression with climbing techniques and makes for comfortable walking.



FALCON

Lightweight seat harness for suspended rescue

FALCON is a lightweight seat harness with a metal ventral attachment point that distributes the load between the waistbelt and the leg loops during suspended rescue. It has a waistbelt and leg loops that are semi-rigid for comfort and equipped with self-locking DOUBLEBACK buckles for quick and easy adjustment. The rear buckle allows a TOP or TOP CROLL chest harness to be attached.



FALCON ASCENT

Lightweight seat harness for rescue operations involving rope ascent

FALCON ASCENT is a lightweight seat harness featuring a two-part ventral attachment point that fastens with an OMNI carabiner. This attachment point makes it more efficient during rescue operations involving rope ascent. The FALCON ASCENT harness features a semi-rigid waistbelt and leg loops for maximum comfort and self-locking DOUBLEBACK buckles for quick and easy adjustment. The rear buckle allows a TOP CROLL chest harness to be attached.



FALCON MOUNTAIN

Very lightweight seat harness for rescue operations involving technical climbing

FALCON MOUNTAIN is a very lightweight seat harness for rescue operations involving technical climbing. It features a bridge construction that favors progression with climbing techniques and makes it comfortable when walking. It has a waistbelt and leg loops that are semi-rigid for comfort and equipped with self-locking DOUBLEBACK buckles for quick and easy adjustment. The rear buckle allows a TOP chest harness to be installed.



Accessory



CHEST'AIR

Chest harness for seat harnesses

The CHEST'AIR chest harness transforms FALCON, FALCON MOUNTAIN, AVAO SIT and SEQUOIA SRT seat harnesses into fall-arrest harnesses. Connects simply to the harness ventral attachment point for rapid installation. It adapts easily to all body types with its DOUBLEBACK self-locking buckles on the shoulder straps and ventral strap.



Litter and evacuation triangles

Rescue litter



STEF

Tilting device for NEST litter

The STEF tilting device joins the three connection points of the NEST litter and allows it to be easily tilted according to the terrain. It has three Am'D TRIACT-LOCK connectors for automatic locking of the connection points, and a swivel for precise orientation of the litter.

NEST

Litter for confined spaces

The NEST litter was developed in partnership with the French national caving rescue organization. It allows a victim to be transported horizontally, vertically or at an angle. It handles easily, and simplifies loading the victim. It is suitable for all technical rope rescue, particularly in confined spaces.

Accessory



Bag for NEST litter

The bag for the NEST litter allows it to be transported and stored. The openings at either end allow the handles of the litter to protrude, for easier handling. It is equipped with three handles and a bandolier system for easier transport.

Evacuation triangles

Evacuation triangles are mainly used for rescue on ski lifts and by firefighters. They allow unequipped people to be evacuated in minimal time.



PITAGOR

Evacuation triangle with shoulder straps

The PITAGOR is an evacuation triangle with shoulder straps that is easy to put on and adjust with the DOUBLEBACK self-locking buckles.



BERMUDE

Evacuation triangle without shoulder straps

The BERMUDE is an evacuation triangle without shoulder straps that is easily put on and adapts without adjustment to different sizes.



LIFT

Spreader for harnesses

Spreader for full-body harnesses or seat harnesses used in conjunction with a chest harness, allowing upright descent (for confined spaces).



CARITOOOL

Harness tool holder

The CARITOOOL tool holder provides one-handed tool access and storage. It slips onto the harness straps and stays in place, thanks to its stabilizing clip. The gate has a protective feature that limits accidental snagging. It is available in two sizes.



RING OPEN

Multidirectional gated ring

See page 104 for details on the RING OPEN gated ring.



Shackles

Shackles for connecting a seat. Connection to the gated attachment point on harnesses ensures optimal integration of equipment.



Lanyard connector holder

Lanyard connector holder (pack of 2)

Lanyard connector holders install on the shoulder straps of VOLT, VOLT WIND, AVAO BOD, AVAO BOD FAST and ASTRO BOD FAST harnesses and TOP, TOP CROLL S and TOP CROLL L chest harnesses. They provide stowage for the MGO connectors on fall-arrest lanyards, on each shoulder strap, allowing the user to be unhindered by the lanyard and to keep the connectors within reach. In the event of a fall, the system releases the MGO connectors and allows the absorber to be deployed.



TOOLBAG

Tool pouch

The TOOLBAG tool pouch allows the user to organize his/her tools during suspended work. The cord lock allows the pouch to be closed easily during transport or when moving about. The pouch attaches easily to any type of harness. Available in three sizes: XS, S and L.



PORTO

Webbing equipment loop

Webbing equipment loop attaches to a pack's internal loop for organizing equipment.







BOLTBAG

Equipment pouch

Equipment pouch for organizing a hammer, bolting gear and other equipment. It has two pockets and exterior holster.



General purpose harnesses

		European versions		International versions	
		References	Certifications	References	Certifications
Fall-arrest harness					
 NEW 2021 NEWTON	NEWTON	C073AA01	CE EN 361 EAC	C073BA01	CE EN 361 EAC ANSI Z359.11 CSA Z259.10
		C073AA02		C073BA02	
	NEWTON FAST	C073CA01		C073DA01 C073IA00 (1)	
		C073CA02		C073DA02 C073IA01 (1)	
	NEWTON EASYFIT	C073EA00		C073FA00	
		C073EA01		C073FA01	
		C073EA02		C073FA02	
NEW 2021 HI-VIZ vest for NEWTON harnesses	C073GA00	■	-	-	-
	C073HA00	■	-	-	-
NEW 2021 Leg loop padding for NEWTON harnesses	C073JA00	-	-	-	-
Fall-arrest and work positioning harnesses					
 VOLT	VOLT	C072AA00	CE EN 361 EN 358 EN 813 EAC	C072CA00	ANSI Z359.11 CSA Z259.10 CE EN 361 CE EN 358
		C072AA01		C072CA01	
		C072AA02		C072CA02	
	VOLT WIND	C072BA00		C072DA00	
		C072BA01		C072DA01	
		C072BA02		C072DA02	
Seat for VOLT harnesses	C072EA00	CE EN 358 (3)	-	-	-
Harnesses for fall arrest, work positioning and suspension					
 AVAO BOD	AVAO BOD	C071AA00	CE EN 361 EN 358 EN 813 EAC	C071CA00	ANSI Z359.11 NFPA 1983 class III CSA Z259.10 CE EN 361 CE EN 358 CE EN 813
		C071AA01		C071CA01	
		C071AA02		C071CA02	
	AVAO BOD FAST	C071BA00 C071BA03 (1)		C071DA00 C071DA03 (1)	
		C071BA01 C071BA04 (1)		C071DA01 C071DA04 (1)	
		C071BA02 C071BA05 (1)		C071DA02 C071DA05 (1)	
TOP	C081AA00 C081AA01 (1)	CE EN 361 (2) EAC	-	-	-
 AVAO SIT	AVAO SIT	C079AA00 C079AA02 (1)	CE EN 358 EN 813 EAC	-	-
		C079AA01 C079AA03 (1)			
	AVAO SIT FAST	C079BA00			
		C079BA01 C079BA02			



Dorsal	Attachment points				Sizes				Weight
	Sternal	Ventral	Hip	Size	Waistbelt	Leg loops	Height		
●	●	-	-	1	70 - 93 cm	47 - 62 cm	165 - 185 cm	1000 g 1030 g (4)	
				2	83 - 120 cm	50 - 65 cm	175 - 200 cm	1030 g 1060 g (4)	
●	●	-	-	1	70 - 93 cm	47 - 62 cm	165 - 185 cm	1010 g 1355 g (4)	
				2	83 - 120 cm	50 - 65 cm	175 - 200 cm	1050 g 1395 g (4)	
●	●	-	-	0	65 - 80 cm	44 - 59 cm	160 - 180 cm	1310 g 1655 g (4)	
				1	70 - 93 cm	47 - 62 cm	165 - 185 cm	1370 g 1715 g (4)	
				2	83 - 120 cm	50 - 65 cm	175 - 200 cm	1420 g 1765 g (4)	
-	-	-	-	-	-	-	-	380 g	
-	-	-	-	-	-	-	-	70 g	
●	●	● (5)	●	0	65 - 80 cm	44 - 59 cm	160 - 180 cm	2100 g 2300 g (4)	
				1	70 - 93 cm	47 - 62 cm	165 - 185 cm	2150 g 2350 g (4)	
				2	83 - 120 cm	50 - 65 cm	175 - 200 cm	2230 g 2430 g (4)	
●	●	● (5)	●	0	65 - 80 cm	44 - 59 cm	160 - 180 cm	2150 g 2350 g (4)	
				1	70 - 93 cm	47 - 62 cm	165 - 185 cm	2200 g 2400 g (4)	
				2	83 - 120 cm	50 - 65 cm	175 - 200 cm	2280 g 2480 g (4)	
-	-	-	-	-	-	-	-	1050 g	
●	●	●	●	0	65 - 80 cm	44 - 59 cm	160 - 180 cm	2045 g 2215 g (4)	
				1	70 - 93 cm	47 - 62 cm	165 - 185 cm	2090 g 2260 g (4)	
				2	83 - 120 cm	50 - 65 cm	175 - 200 cm	2170 g 2340 g (4)	
●	●	●	●	0	65 - 80 cm	44 - 59 cm	160 - 180 cm	2000 g 2350 g (4)	
				1	70 - 93 cm	47 - 62 cm	165 - 185 cm	2045 g 2400 g (4)	
				2	83 - 120 cm	50 - 65 cm	175 - 200 cm	2125 g 2485 g (4)	
-	●	-	-	-	-	-	160 - 200 cm	660 g	
-	-	●	●	1	70 - 93 cm	47 - 62 cm	165 - 185 cm	1175 g	
				2	83 - 120 cm	50 - 65 cm	175 - 200 cm	1190 g	
-	-	●	●	0	65 - 80 cm	44 - 59 cm	160 - 180 cm	1115 g	
				1	70 - 93 cm	47 - 62 cm	165 - 185 cm	1130 g	
				2	83 - 120 cm	50 - 65 cm	175 - 200 cm	1145 g	

(1) black harness, (2) with AVAO SIT, AVAO SIT FAST, FALCON, FALCON MOUNTAIN, SEQUOIA SRT seat harness, (3) with VOLT harnesses, (4) weight of international version, (5) on European versions.



Specialized harnesses

		European versions		International versions		
		References	Certifications	References	Certifications	
Rope access harnesses						
ASTRO BOD FAST		C083AA00	CE EN 361 EN 358 EN 813 EN 12841 type B EAC	C083BA00 C083BA03 (1)	ANSI Z359.11 NFPA 1983 class III CSA Z259.10 CE EN 361 EN 358 EN 813 EN 12841 type B	
		C083AA01		C083BA01 C083BA04 (1)		
		C083AA02		C083BA02 C083BA05 (1)		
TOP CROLL S		C081BA00	CE EN 361 (2) EN 12841 type B EAC	-	-	
TOP CROLL L		C081CA00	CE EN 361 (2) EN 12841 type B EAC	-	-	
ASTRO SIT FAST		C085AA00	CE EN 358 EN 813 EAC	-	-	
		C085AA01				
		C085AA02				
PODIUM		S071AA00	-	-	-	
Tree care harnesses						
SEQUOIA		SEQUOIA SRT	CE EN 358 EN 813 EAC	-	-	
		C069BA00				
		C069BA01				
		C069BA02				
		SEQUOIA				
		C069AA00				
		C069AA01				
		C069AA02				
Shoulder straps		C069DA00	-	-	-	
Seat		S069AA00	-	-	-	
Adjustable attachment bridge		C69R	-	-	-	
Attachment bridge	40 cm	C069CA00	-	-	-	
	45 cm	C069CA01				
	50 cm	C069CA02				
Rescue harnesses						
FALCON		FALCON	CE EN 358 EN 813 EAC	-	-	
		C038AA00				
		C038AA01 / C038AA03 (1) C038AA02 / C038AA04 (1)				
		FALCON ASCENT	C038BA00 C038BA01	CE EN 358 EN 813 EAC	-	-
		FALCON MOUNTAIN	C038CA00 C038CA01	CE EN 358, EN 813 EN 12277 type C EAC	-	-
		CHEST'AIR		C98A	CE EN 361 (3) EN 12277 type D	-
Litter and evacuation triangles						
NEST		S061AA00	-	-	-	
STEF		S059AA0 / S059BA00 (5)	-	-	-	
Bag for NEST litter		S062AA00	-	-	-	
PITAGOR		C80 BR	CE EN 1497 - EN 1498	-	-	
BERMUDE		C80	EN 1498	-	-	
Harness accessories						
LIFT		L54	CE	-	-	
CARITool		P042AA00	-	-	-	
		P042AA01				
TOOLBAG		S047AA00	-	-	-	
		S47Y S				
		S47Y L				
RING OPEN		P28	CE EN 362	-	-	
Shackles		C087AA00	-	-	-	
Lanyard connector holder		C088AA00 (yellow)	-	-	-	
		C088AA01 (black)				
BOLTBAG		C11 A	-	-	-	
PORTO		C33	-	-	-	



Dorsal	Attachment points				Sizes				Weight
	Sternal	Ventral	Hip	Size	Waistbelt	Leg loops	Height		
●	●	●	●	0	65 - 80 cm	44 - 59 cm	160 - 180 cm	1855 g / 2480 g (4)	
				1	70 - 93 cm	47 - 62 cm	165 - 185 cm	1900 g / 2530 g (4)	
				2	83 - 120 cm	50 - 65 cm	175 - 200 cm	1980 g / 2620 g (4)	
-	●	-	-	-	-	-	160 - 200 cm	515 g	
-	●	-	-	-	-	-	160 - 200 cm	600 g	
-	-	●	●	0	65 - 80 cm	44 - 59 cm	160 - 180 cm	1025 g	
				1	70 - 93 cm	47 - 62 cm	165 - 185 cm	1040 g	
				2	83 - 120 cm	50 - 65 cm	175 - 200 cm	1055 g	
-	-	-	-	-	-	-	-	1060 g	
-	-	●	●	0	65 - 80 cm	44 - 59 cm	-	1580 g	
				1	70 - 93 cm	47 - 62 cm	-	1630 g	
				2	83 - 120 cm	50 - 65 cm	-	1700 g	
-	-	-	●	0	65 - 80 cm	44 - 59 cm	-	1480 g	
				1	70 - 93 cm	47 - 62 cm	-	1530 g	
				2	83 - 120 cm	50 - 65 cm	-	1600 g	
-	-	-	-	-	-	-	-	190 g	
-	-	-	-	-	-	-	-	920 g	
-	-	-	-	-	-	-	-	220 g	
-	-	-	-	S	-	-	-	65 g	
				M				70 g	
				L				75 g	
-	-	●	●	0	65 - 80 cm	44 - 59 cm	-	840 g	
				1	70 - 93 cm	47 - 62 cm	-	855 g	
				2	83 - 120 cm	50 - 65 cm	-	885 g	
-	-	●	●	1	70 - 93 cm	47 - 62 cm	-	765 g	
				2	83 - 120 cm	50 - 65 cm	-	795 g	
-	-	●	●	1	70 - 93 cm	47 - 62 cm	-	810 g	
				2	83 - 120 cm	50 - 65 cm	-	840 g	
-	●	-	-	-	-	-	160 - 200 cm	495 g	
-	-	-	-	-	-	-	-	13100 g	
-	-	-	-	-	-	-	-	640 g / 620 g (5)	
-	-	-	-	-	-	-	-	1860 g	
-	-	-	-	-	-	-	-	1290 g	
-	-	-	-	-	-	-	-	795 g	
-	-	-	-	-	-	-	-	520 g	
				S				35 g	
-	-	-	-	L	-	-	-	75 g	
				XS (1.3 l)				105 g	
				S (2.5 l)				170 g	
-	-	-	-	L (5 l)	-	-	-	240 g	
				-				70 g	
-	-	-	-	-	-	-	-	20 g	
-	-	-	-	-	-	-	-	45 g	
-	-	-	-	-	-	-	-	170 g	
-	-	-	-	-	-	-	-	18 g	

(1) black harness, (2) with ASTRO SIT FAST, AVAO SIT, AVAO SIT FAST, FALCON, FALCON ASCENT, SEQUOIA SRT harnesses, (3) with FALCON, FALCON MOUNTAIN, AVAO SIT, SEQUOIA SRT harnesses, (4) international version, (5) for NEST litter before 2020.



HELMETS

Essential for work at height and certain industrial activities, helmets provide the user with effective protection from falling objects, or if the person him/herself falls.



Comfortable helmets

Helmets with webbing suspension for optimal comfort.



Lightweight helmets

Lightweight, compact helmets with hybrid construction liner (EPP and EPS foams).



Protective eye and face shields

Protective eye and face shields for VERTEX and STRATO helmets.



Accessories



Hats and balaclava

Hats and balaclava for protection against rain and cold.



Essential for work at height and certain industrial activities, helmets provide the user with effective protection from falling objects, or if the person him/herself falls. Thanks to their very secure fit, Petzl helmets are comfortable to wear in any situation. With a complete line of entirely modular accessories, they meet the diverse needs of professionals.

• **Excellent fit on the head**

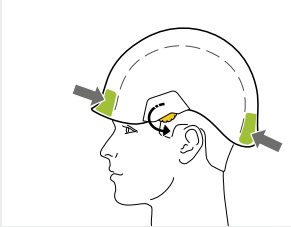

CENTERFIT adjustment

The CENTERFIT adjustment system allows the helmet to be perfectly centered on the head. The headband is easy to adjust by simultaneously rotating the two side adjustment wheels, even while wearing gloves.

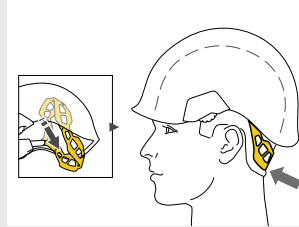

FLIP&FIT system

The FLIP&FIT system immediately positions the headband in a low position, to ensure that the helmet fits securely on the head. The headband folds into the shell for easy storage and transport.

• **DUAL chinstrap strength is adjustable, to adapt to any work situation**

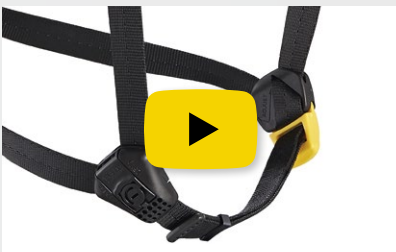

The DUAL chinstrap allows the worker to adjust chinstrap strength in order to adapt the helmet to different environments: work at height (EN 12492) or on the ground (EN 397).

The clip has two positions, corresponding to the following two uses:

- higher strength to limit the risk of the helmet coming off in a fall (strength > 50 daN)
- lower strength to limit the risk of strangulation, by releasing if snagged when user is at ground level (strength < 25 daN)

Solution for different protection needs

		Helmets with unventilated external shell		Helmets with ventilated external shell	
		VERTEX	STRATO	VERTEX VENT	STRATO VENT
 PENETRATION PROTECTION	 IMPACT PROTECTION	Protection against falling objects		•	•
 VENTILATION	Ventilation holes allow airflow through the helmet		-	•	
 ELECTRICAL PROTECTION	Protection against electrical hazards		•	-	
 MOLTEN METAL PROTECTION	Protection against molten metal splash		•	•	-
 LATERAL DEFORMATION	Protection against lateral deformation		•	•	

• **Modular accessories**

Extensive line of protective eye and face shields, headlamps and accessories

- eye shields, face shields for protection against electric arc hazards, specific shields for tree care
- headlamps for lighting
- nametag holder, nape protector, helmet protectors, chinstraps



Nametag holder



Helmet protector



PIXA / DUO



Stickers



VIZIR / VIZIR SHADOW



Nape protector



VIZEN
VIZEN MESH



Headbands and foam



Storage bag

VERTEX
+ Nametag holder



VERTEX VENT HI-VIZ
+ PIXA



STRATO VENT
+ VIZEN MESH
+ Nape protector



• Multiple choices



Available in assorted colors

VERTEX helmets are available in seven standard colors; STRATO helmets are available in four colors. VERTEX and STRATO helmets are also available in two HI-VIZ versions, with a fluorescent outer shell (yellow or orange), phosphorescent clips and reflective bands, for optimal visibility of the worker, day or night.

Multiple certifications

Depending on the model, Petzl helmets meet the requirements for the following certifications:

- European EN 397, EN 12492 and EN 50365
- American ANSI Z89.1
- Canadian CSA Z94.1
- Russian EAC
- Australian AS/NZS 1801

• Easy to install, very modular

All Petzl helmets can be adapted to additional needs for protection or lighting in just a few seconds, thanks to the EASYCLIP system and a variety of inserts.

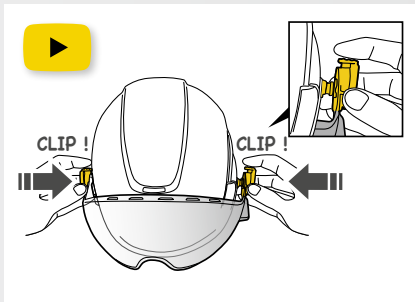

EASYCLIP

The EASYCLIP system allows quick installation of a protective shield. EASYCLIP is easy to install and is compatible with all Petzl helmets and shields. It comes with every protective eye and face shield.

• Petzl Custom service for helmets



CUSTOM

Petzl Custom service can:

- personalize the helmet with a logo and reflective stickers
- pre-mount Petzl eye and face shields and accessories of your choice onto the helmet, for a ready-made

solution, with each helmet delivered in an individual transport pouch
Available for orders of minimum 20 helmets.

VERTEX CUSTOM: A010XY
STRATO CUSTOM: A020XY

• Comfortable construction



VERTEX helmets have a six-point webbing suspension system, conforming to the shape of the head for maximum comfort. Shock absorption is achieved through deformation of the external shell.

• Lightweight construction



The liner of STRATO helmets is designed in two parts: EPP (expanded polypropylene) and EPS (expanded polystyrene), for reduced weight. Shock absorption is achieved through deformation of the liner.



VERTEX®

Comfortable helmet

The VERTEX helmet is very comfortable, thanks to its six-point textile suspension and CENTERFIT and FLIP&FIT systems, which ensure that the helmet fits securely on the head. The adjustable-strength chinstrap makes it ideal for both work at height and on the ground. The unventilated outer shell protects against electrical hazards, molten metal splash and flames. With its potential for integration of a Petzl headlamp, hearing protection, and multiple accessories, it is an entirely modular helmet, thus meeting the specific additional needs of professionals.



VERTEX® HI-VIZ

Comfortable high-visibility helmet

The high visibility version features a fluorescent outer shell with phosphorescent clips and reflective bands, for optimal visibility of the worker, day or night.



VERTEX® VENT

Comfortable ventilated helmet

The VERTEX VENT helmet is very comfortable, thanks to its six-point textile suspension and CENTERFIT and FLIP&FIT systems, which ensure that the helmet fits securely on the head. The adjustable-strength chinstrap makes it ideal for both work at height and on the ground. It has ventilation holes with sliding shutters to allow airflow through the helmet. With its potential for integration of a Petzl headlamp, hearing protection, and multiple accessories, it is an entirely modular helmet, thus meeting the specific additional needs of professionals.



VERTEX® VENT HI-VIZ

Comfortable, ventilated high-visibility helmet

The high visibility version features a fluorescent outer shell with phosphorescent clips and reflective bands, for optimal visibility of the worker, day or night.



STRATO®

Lightweight helmet

The STRATO helmet is very lightweight and comfortable, thanks to its CENTERFIT and FLIP&FIT systems, which ensure that the helmet fits securely on the head. The adjustable-strength chinstrap makes it ideal for both work at height and on the ground. The unventilated outer shell protects against electrical hazards, molten metal splash and flames. With its potential for integration of a Petzl headlamp, hearing protection, and multiple accessories, it is an entirely modular helmet, thus meeting the specific additional needs of professionals.



STRATO® HI-VIZ

Lightweight high-visibility helmet

The high visibility version features a fluorescent outer shell with phosphorescent clips and reflective bands, for optimal visibility of the worker, day or night.



STRATO® VENT

Lightweight ventilated helmet

The STRATO VENT helmet is very lightweight and comfortable, thanks to its CENTERFIT and FLIP&FIT systems, which ensure that the helmet fits securely on the head. The adjustable-strength chinstrap makes it ideal for both work at height and on the ground. It has ventilation holes that allow airflow through the helmet. With its potential for integration of a Petzl headlamp, hearing protection, and multiple accessories, it is an entirely modular helmet, thus meeting the specific additional needs of professionals.



STRATO® VENT HI-VIZ

Lightweight, ventilated high-visibility helmet

The high visibility version features a fluorescent outer shell with phosphorescent clips and reflective bands, for optimal visibility of the worker, day or night.



VIZIR

Eye shield with EASYCLIP system for VERTEX and STRATO helmets

The VIZIR eye shield protects the eyes against projectile hazards. It is easy to install on VERTEX and STRATO helmets with the EASYCLIP attachment system. It also has scratch-resistant and anti-fog coatings.



VIZIR SHADOW

Tinted eye shield with EASYCLIP system for VERTEX and STRATO helmets

The VIZIR SHADOW eye shield provides eye protection against projectile hazards. It is easy to install on VERTEX and STRATO helmets with the EASYCLIP attachment system. It has a level 2.5 solar protection filter, and anti-scratch and anti-fog treatments.



VIZEN

Face shield for protection against electric arc hazards, with EASYCLIP system for VERTEX and STRATO helmets

The VIZEN face shield protects against electric arc hazards. This full-coverage shield offers face and eye protection while preserving peripheral vision. It is easily installed on VERTEX and STRATO helmets, thanks to the EASYCLIP attachment system. It also has scratch-resistant and anti-fog coatings.



VIZEN MESH

Face shield for tree care for VERTEX and STRATO helmets, with EASYCLIP system

The VIZEN MESH face shield protects against flying wood chips and shavings. This full-coverage shield offers complete face protection while ensuring good visibility. It is easily installed on VERTEX and STRATO helmets, thanks to the EASYCLIP attachment system.



Nametag holder for VERTEX® and STRATO® helmets

The nametag holder for VERTEX and STRATO helmets allows quick identification of the worker. It is easy to install and provides effective rain protection for business cards.



Nape protector for VERTEX® and STRATO® helmets

The nape protector for VERTEX and STRATO helmets provides effective sun and rain protection for the nape of the neck. Fluorescent colors give the worker optimal visibility, night and day. Available in two colors.



Protector for VERTEX® helmet

The protector for the VERTEX helmet is easy to install and protects the shell from soiling and splash.



Protector for STRATO® helmet

The protector for the STRATO helmet is easy to install and protects the shell from soiling and splash.



Storage bag for VERTEX® and STRATO® helmets

Storage bag to protect VERTEX and STRATO helmets during storage and transport. Thanks to a closed interior compartment, accessories are also protected.



DUAL chinstrap for VERTEX® and STRATO® helmets

This chinstrap can be used to change or replace the chinstrap of VERTEX and STRATO helmets. It allows the worker to modify chinstrap strength in order to adapt the helmet to different environments: work at height or on the ground. Available in two colors and in a long version.

Helmets

Accessories



Headband with comfort foam for VERTEX® and STRATO® helmets
Ready to install headband with comfort foam (standard or absorbent), to extend the life of a VERTEX or STRATO helmet. Pack of 5.



Comfort foam for VERTEX® and STRATO® helmets
Comfort foam (standard or absorbent), ready to install on headband of a VERTEX or STRATO helmet, to prolong its life.



Upper foam for STRATO® helmet
Upper foam installs on the liner of the STRATO helmet, to extend its life. It is comfortable, absorbent and machine-washable.



Transparent stickers for VERTEX® and STRATO® helmets
Transparent stickers allow VERTEX and STRATO helmets to be personalized using a permanent marker or laser printer.



Reflective stickers for VERTEX®
Reflective stickers for increased visibility of VERTEX helmets.



Reflective stickers for STRATO®
Reflective stickers for increased visibility of STRATO helmets.

Hats and balaclava

Buff® is a trademark and property of Original Buff®



LINER

Breathable cap for wicking perspiration

LINER is a breathable cap for wicking perspiration and drying quickly. The seamless fitted design makes it comfortable to wear under a helmet, without getting in the way.



BEANIE

Protective cap for cold and wind

BEANIE is a cap that protects the head on cold and windy days. The design, specific to each zone, optimizes thermal insulation and regulates moisture. The seamless fitted design and side vents make it comfortable to wear under a helmet, without getting in the way.



BALACLAVA

Balaclava for protection against cold and wind

BALACLAVA protects the head, the face and the neck on cold, windy days. The design, specific to each zone, optimizes thermal insulation and regulates moisture. The seamless fitted design and multiple side vents make it comfortable to wear under a helmet, without getting in the way.

		Certifications	Weight
Eye and face shields			
VIZIR	A015AA00	CE EN 166, 1BT, ANSI Z87.1, EAC	80 g
VIZIR SHADOW	A015BA00	CE EN 166, 1BT, CE EN 172, 5-2,5, ANSI Z87.1, EAC	80 g
VIZEN	A014AA00	CE EN 166, 1BT8, CE EN 170, 2C-1,2, GS ET-29, Class 1, ANSI Z87.1, EAC	180 g
VIZEN MESH	A021AA00	CE EN 1731, S, ANSI Z87.1, EAC	117 g

	Color	Version	Weight
--	-------	---------	--------

Accessories				
Nametag holder for VERTEX and STRATO helmets	A018AA00	-	-	45 g
Nape protector for VERTEX and STRATO helmets	A019AA00	yellow	-	55 g
	A019AA01	orange	-	
Protector for VERTEX helmet	A012AA00	-	-	60 g
Protector for STRATO helmet	A012BA00	-	-	60 g
Storage bag for VERTEX and STRATO helmets	A022AA00	-	-	175 g
DUAL chinstrap for VERTEX and STRATO helmets	A010FA00	yellow / black	standard	34 g
	A010FA01	black	standard	
	A010FA02	yellow / black	extended	
Headband with comfort foam for VERTEX and STRATO helmets	A010HA00	-	standard	30 g
	A010JA00		absorbent	
Comfort foam for VERTEX and STRATO helmets	A010KA00	-	standard	15 g
	A010LA00		absorbent	
Upper foam for STRATO helmet	A020EA00	-	absorbent	15 g
Transparent stickers for VERTEX and STRATO	A10100	-	-	-
Reflective stickers for VERTEX	A010MA00	-	-	10 g
Reflective stickers for STRATO	A020FA00	-	-	10 g

	Size	Head circumference	Weight
--	------	--------------------	--------



Hats and balaclava				
LINER	A016AA00	M - L	56 - 59 cm	15 g
	A016AA01	L - XL	59 - 63 cm	
BEANIE	A016BA00	M - L	56 - 59 cm	25 g
	A016BA01	L - XL	59 - 63 cm	
BALACLAVA	A016CA00	M - L	56 - 59 cm	60 g
	A016CA01	L - XL	59 - 63 cm	





Helmets

		European certifications	U.S. certifications	Canadian certification	Russian certification	Australian certification	IMPACT PROTECTION			PENETRATION PROTECTION	
							EN 397	EN 12492	ANSI Z89.1	EN 397	ANSI Z89.1

Comfortable helmets

 VERTEX	A010AA00	<input type="checkbox"/>	CE EN 397 EN 50365 EN 12492 (6)	ANSI Z89.1 Type I Class E	CSA Z94.1 Type I Class E (5)	EAC	AS/NZS 1801	●	●	●	●	●
	A010AA01	<input type="checkbox"/>										
	A010AA02	<input type="checkbox"/>										
	A010AA03	<input type="checkbox"/>										
	A010AA04	<input type="checkbox"/>										
	A010AA05	<input type="checkbox"/>										
	A010AA06	<input type="checkbox"/>										
VERTEX HI-VIZ	A010DA00	<input type="checkbox"/>	CE EN 397 EN 50365 EN 12492 (6)	ANSI Z89.1 Type I Class E	CSA Z94.1 Type I Class E (5)	EAC	AS/NZS 1801	●	●	●	●	●
	A010DA01	<input type="checkbox"/>										
 VERTEX VENT	A010CA00	<input type="checkbox"/>	CE EN 12492 EN 397	ANSI Z89.1 Type I Class C	-	EAC	-	●	●	●	●	●
	A010CA01	<input type="checkbox"/>										
	A010CA02	<input type="checkbox"/>										
	A010CA03	<input type="checkbox"/>										
	A010CA04	<input type="checkbox"/>										
	A010CA05	<input type="checkbox"/>										
	A010CA06	<input type="checkbox"/>										
VERTEX VENT HI-VIZ	A010EA00	<input type="checkbox"/>	CE EN 12492 EN 397	ANSI Z89.1 Type I Class C	-	EAC	-	●	●	●	●	●
	A010EA01	<input type="checkbox"/>										

Lightweight helmets

 STRATO	A020AA00	<input type="checkbox"/>	CE EN 397 (1) EN 50365 (2)	ANSI Z89.1 Type I Class E	-	EAC	-	●	●	●	●	●
	A020AA01	<input type="checkbox"/>										
	A020AA02	<input type="checkbox"/>										
	A020AA03	<input type="checkbox"/>										
STRATO HI-VIZ	A020CA00	<input type="checkbox"/>	CE EN 397 (1) EN 50365 (2)	ANSI Z89.1 Type I Class E	-	EAC	-	●	●	●	●	●
	A020CA01	<input type="checkbox"/>										
 STRATO VENT	A020BA00	<input type="checkbox"/>	CE EN 12492	ANSI Z89.1 Type I Class C	-	EAC	-	●	●	●	●	●
	A020BA01	<input type="checkbox"/>										
	A020BA02	<input type="checkbox"/>										
	A020BA03	<input type="checkbox"/>										
STRATO VENT HI-VIZ	A020DA00	<input type="checkbox"/>	CE EN 12492	ANSI Z89.1 Type I Class C	-	EAC	-	●	●	●	●	●
	A020DA01	<input type="checkbox"/>										

		CHINSTRAP STRENGTH			VENTILATION		ELECTRICAL PROTECTION			MOLTEN METAL PROTECTION		FLAME RESISTANCE		LATERAL DEFORMATION		LOW TEMPERATURE		HIGH VISIBILITY		Head circumference	Weight
		EN 397 (3)	EN 12492 (4)	ANSI Z89.1	EN 12492	EN 397	EN 50365	ANSI Z89.1	EN 397	EN 397	ANSI Z89.1	EN 397	EN 397	ANSI Z89.1	EN 397	ANSI Z89.1	ANSI Z89.1				
		•	•	•	-	•	•	•	•	•	•	•	•	•	•	•	•	•	•	53-63 cm	490 g
		•	•	•	-	•	•	•	•	•	•	•	•	•	•	•	•	•	•	53-63 cm	495 g
		•	•	•	•	-	-	-	•	•	•	•	•	•	•	•	•	•	•	53-63 cm	490 g
		•	•	•	•	-	-	-	•	•	•	•	•	•	•	•	•	•	•	53-63 cm	495 g
		•	•	•	-	•	•	•	•	•	•	•	•	•	•	•	•	•	•	53-63 cm	435 g
		•	•	•	-	•	•	•	•	•	•	•	•	•	•	•	•	•	•	53-63 cm	445 g
		•	•	•	•	-	-	-	-	-	-	•	•	•	•	•	•	•	•	53-63 cm	415 g
		•	•	•	•	-	-	-	-	-	-	•	•	•	•	•	•	•	•	53-63 cm	425 g



(1) meets all requirements of the EN 397 standard, except the requirement for internal vertical clearance. (2) partly meeting the CE EN 397 standard. (3) lower strength (< 25 daN) limits risk of strangulation, by releasing if snagged when user is at ground level. (4) higher strength (> 50 daN) limits risk of helmet coming off in a fall. (5) for VERTEX Canada version. (6) meets all requirements of the EN 12492 standard, except the ventilation requirement.

LANYARDS AND ENERGY ABSORBERS

Whether for work positioning or to have an energy absorber that limits the force transmitted to the user in the event of a fall, Petzl offers a complete line of lanyards for different applications.



Wind turbine maintenance on a wind farm in Vallée de l'Arce, France © 2020 Petzl distribution - Vuedici.org - Boralex SAS

Depending on the model, the ends of Petzl lanyards are equipped with plastic sheaths, or with STRINGS. These items help keep the connector positioned on the major axis, and facilitate clipping. They also protect the ends from abrasion due to repeated rubbing.



Plastic sheath



STRING

General purpose lanyards



Work positioning lanyards

Adjustable lanyards with ergonomic handle allow comfortable positioning at a workstation.



Fall-arrest lanyards

Lanyards with an energy absorber, used when there is a fall hazard. Petzl offers three types of lanyards with an absorber:

- single (ABSORBICA-I) or double (ABSORBICA-Y) lanyards with an energy absorber
- lanyards that can be combined with an ABSORBICA energy absorber to create a single or double energy-absorbing lanyard with a maximum length of two meters

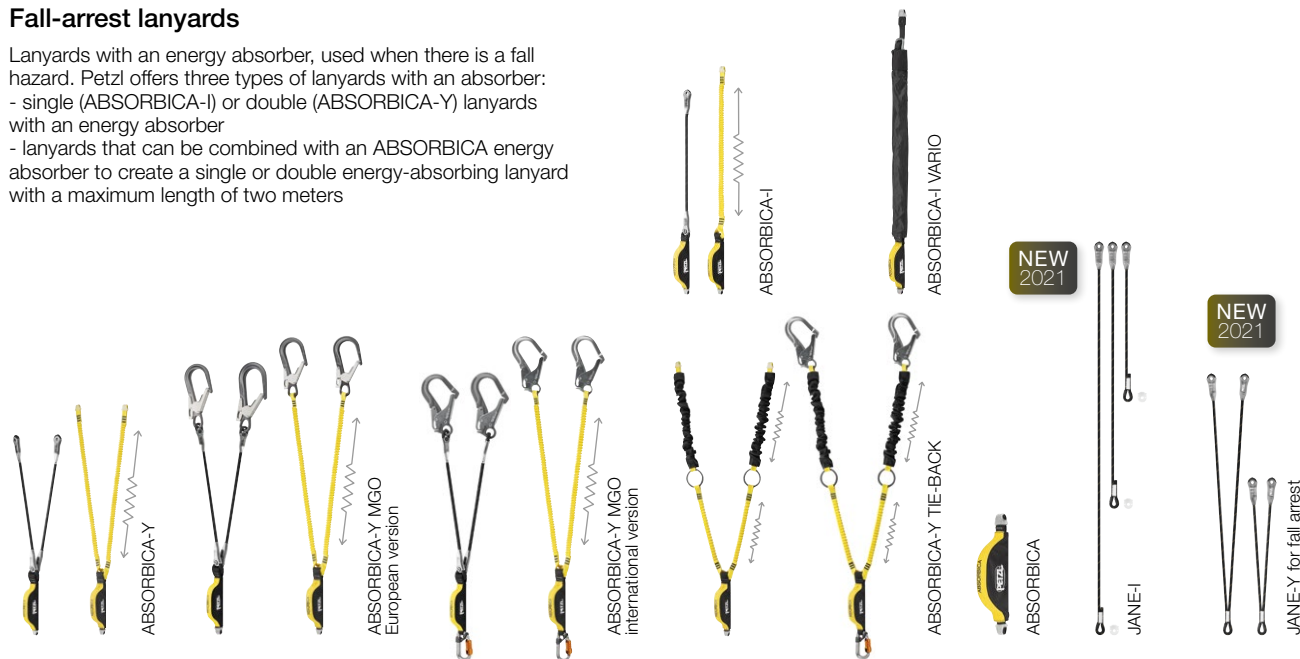

Specialized lanyards

Progression lanyards for rope access

Fixed or adjustable lanyards, for any type of progression. Available in single and double versions.



Positioning lanyard for rope access

Adjustable lanyard with rope adjuster, for positioning at a workstation.

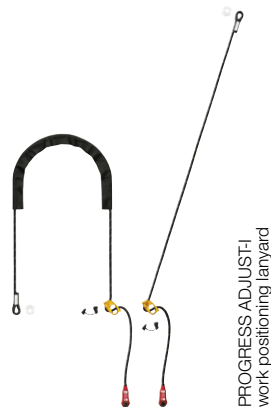

Tree care lanyards

Adjustable positioning lanyards that allow comfortable positioning for tree care work.

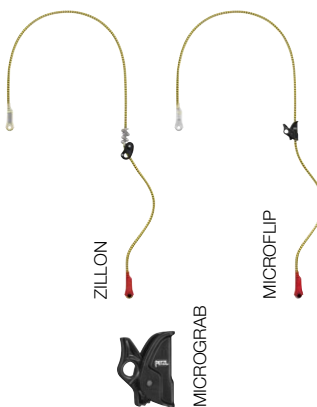

Helivac lanyards

Lanyards for helicopter drop-off and recovery.



Work positioning lanyards

Positioning lanyards allow the user to position him/herself precisely at a workstation, with feet supported on the structure. They can adapt to different anchoring configurations.

• Versatile

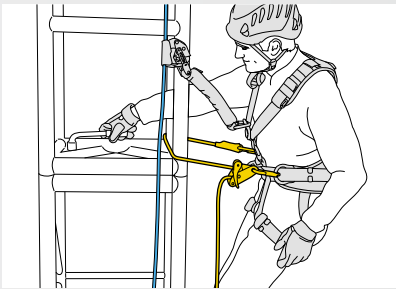

Double mode use

The GRILLON lanyard can be used in double mode (on the harness side attachment points) when the user works with weight on his/her feet. This type of attachment ensures better load distribution on the belt. The user precisely adjusts his/her position by pressing on the lanyard's pivoting cam.



Single mode use

When the anchor is located above the user, the GRILLON lanyard is connected to the harness ventral attachment point, so that the load is comfortably distributed between the belt and leg loops. The user adjusts his/her position by operating the handle, while holding the free end of the lanyard.

• Easy handling



Sewn terminations with plastic sheaths

Sewn terminations increase strength (compared to a knotted termination) while reducing bulk. These plastic sheaths protect the stitching from abrasion and facilitate handling by holding the connector in position.

• Differentiation of lanyard lengths

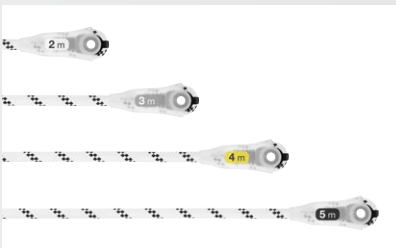

Lanyard length is immediately identified by a color-coded label at the connector end.

• Petzl Custom service for work positioning lanyards

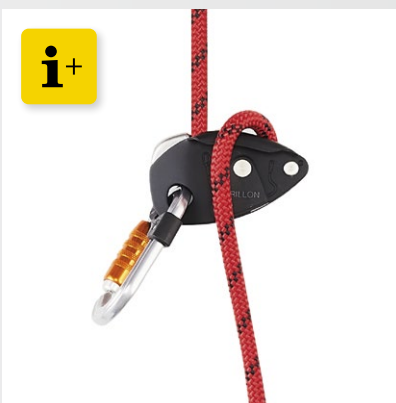

Petzl Custom service allows you to choose:

- lanyard type: standard or high-strength rope
- lanyard color
- lanyard length
- type of lanyard-end connectors and harness connector

The assembly of various components of your choice offers a ready-made solution specific to the user.

GRILLON CUSTOM: L052XYXX

• Without connector



GRILLON lanyards are sold without connectors, so that they can be combined with any type of connector, depending on the user's requirements.

• With HOOK connector



GRILLON HOOK lanyards are equipped with a HOOK auto-locking connector, ideal for connections using the harness side attachment points.

• With MGO connector



GRILLON lanyards, in combination with an MGO auto-locking connector, are ideal for connection to metal structures or to large-diameter cables and bars.



GRILLON

Adjustable lanyard for work positioning

The GRILLON adjustable lanyard is used to make work positioning systems, to complement a fall-arrest system. Its length can be very easily and precisely adjusted as necessary for comfortable positioning at the workstation. Depending on the configuration, it can be used in single or double mode. GRILLON is available in seven lengths (2, 3, 4, 5, 10, 15 and 20 m), and also in black. It is certified to North American, European and Russian standards.



GRILLON PLUS

Adjustable work positioning lanyard with high abrasion resistance

The GRILLON PLUS lanyard is used to make work positioning systems, to complement a fall-arrest system. Its length can be very easily and precisely adjusted as necessary for comfortable positioning at the workstation. The aramid fiber rope provides excellent abrasion resistance. Depending on the configuration, it can be used in single or double mode. GRILLON PLUS is available in two lengths: 2 and 3 m, and is certified to North American, European and Russian standards.



GRILLON HOOK European version

Adjustable work positioning lanyard with HOOK connector

The GRILLON HOOK adjustable lanyard is used to make work positioning systems, to complement a fall-arrest system. Its length can be very easily and precisely adjusted as necessary for comfortable positioning at the workstation. Its HOOK connector is ideal for using the lanyard in double mode on the harness side attachment points. The GRILLON HOOK (European version) is available in four lengths (2, 3, 4 and 5 m) and is certified to European and Russian standards.



GRILLON HOOK international version

Adjustable work positioning lanyard with HOOK connector

The GRILLON HOOK adjustable lanyard is used to make work positioning systems, to complement a fall-arrest system. Its length can be very easily and precisely adjusted as necessary for comfortable positioning at the workstation. Its HOOK connector is ideal for using the lanyard in double mode on the harness side attachment points. GRILLON HOOK (international version) is available in four lengths (2, 3, 4 and 5 m) and is certified to North American and European standards.



GRILLON MGO

Adjustable work positioning lanyard with MGO connector

The GRILLON MGO lanyard is used to make work positioning systems, to complement a fall-arrest system. Its length can be very easily and precisely adjusted as necessary for comfortable positioning at the workstation. Connector with large gate opening is ideal for connection to metal structures or to large-diameter cables and bars. GRILLON MGO is available in two lengths: 2 and 3 m, and is certified to North American and European standards.



Fall-arrest lanyards

These lanyards are used when there is a fall hazard and are connected to the sternal or dorsal attachment point on the harness. The integrated absorber provides energy absorption in a fall and thus limits the impact force on the user.

• Progressive energy absorption adapted to the user's weight

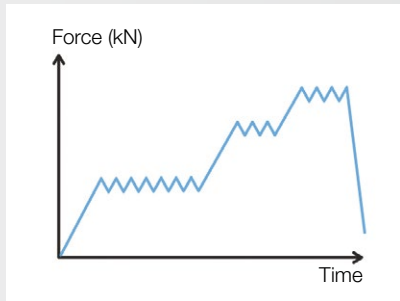

In the event of a fall, the tearing of the energy absorber webbing limits the impact force on the user. The lanyards are designed for users who weigh between 50 and 130 kg. The progressive tearing of the webbing reduces the deceleration on lightweight users.

• Compact and abrasion resistant energy absorber



The energy absorber is very compact, to avoid hindering the user's movements, or interfering with work. A durable fabric pouch helps protect the energy absorber from abrasion and potential contaminants.

• Different connectors depending on the type of structure

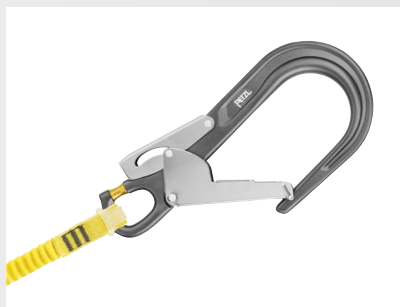

MGO or MGO OPEN large-opening connectors

MGO and MGO OPEN connectors allow for connection to metal structures or to large-diameter cables and bars. Lanyards without connectors can be equipped with MGO OPEN 60 or 110 connectors that can be re-used if the lanyard is damaged.

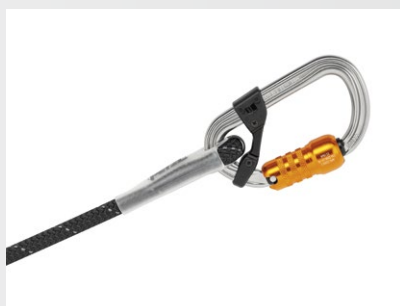

Classic connectors

Lanyards without connectors can be equipped with classic aluminum (OK, Am'D and Bm'D) or steel connectors (OXAN TRIACT-LOCK). They enable connection to lifelines or to single anchor points.

• Available in several lengths, with or without a connector

ABSORBICA lanyards are available in two lengths:

- 80 cm of rope

- 150 cm of elasticized webbing, to avoid hindering progression

They are available with or without a connector, according to user needs.

• For progression on a lifeline without passing intermediate anchors

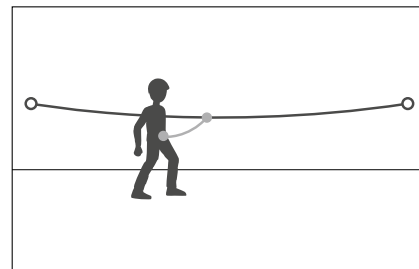

ABSORBICA-I single lanyards are designed especially for protection on a horizontal lifeline or on an elevated platform.

• For progression on a vertical structure or a lifeline, and when passing intermediate anchors

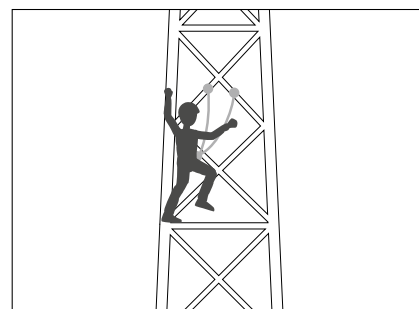
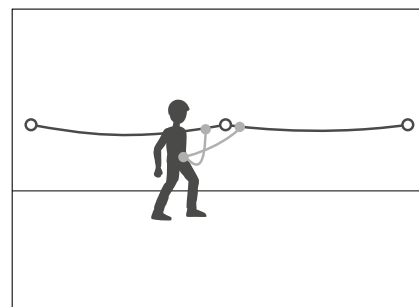

The ABSORBICA-Y lanyards with two arms allow for continuous protection, by successively detaching and re-attaching the two arms.

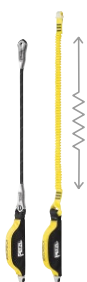

ABSORBICA-I

Single lanyard with integrated energy absorber

ABSORBICA-I is a single lanyard with compact energy absorber designed for progression on a horizontal lifeline (rope or cable) or on an elevated platform, without passing intermediate anchors. It has several installation options on the harness and can be used with different types of connectors. It is available in two lengths: 80 or 150 cm versions (without connectors). The 150 cm version has an elasticized arm, to avoid hindering progression. Depending on the connectors used, ABSORBICA-I is certified to American, European and Russian standards.

ABSORBICA-I VARIO

Adjustable single lanyard with integrated energy absorber

ABSORBICA-I VARIO is an adjustable single lanyard with compact energy absorber designed for progression on a horizontal lifeline (rope or cable) or on an elevated platform, without passing intermediate anchors. It features the VARIO adjustment system, allowing the lanyard length to be adjusted in order to reduce potential fall height. Depending on the connectors used, ABSORBICA-I VARIO is certified to American, European and Russian standards.



ABSORBICA-Y

Double lanyard with integrated energy absorber

ABSORBICA-Y is a double lanyard with compact energy absorber, designed for progression on a vertical structure or a horizontal lifeline, and for passing intermediate anchors. It has several installation options on the harness and can be used with different types of connectors. It is available in two lengths: 80 or 150 cm versions (without connectors). The 150 cm version has elasticized arms, to avoid hindering progression. Depending on the connectors used, the ABSORBICA-Y is certified to American, European, and Russian standards.

ABSORBICA-Y MGO European version

Double lanyard with integrated energy absorber and MGO connectors

ABSORBICA-Y MGO is a double lanyard with compact energy absorber, designed for progression on a vertical structure or a horizontal lifeline, and when passing intermediate anchors. It is available in two lengths: 80 or 150 cm versions (without connectors). The 150 cm version has elasticized arms, to avoid hindering progression. With two MGO large-opening connectors, it is certified to European and Russian standards.

ABSORBICA-Y MGO international version

Double lanyard with integrated energy absorber and MGO connectors

ABSORBICA-Y MGO is a double lanyard with compact energy absorber, designed for progression on a vertical structure or a horizontal lifeline, and when passing intermediate anchors. It is available in two lengths: 80 or 150 cm versions (without connectors). The 150 cm version has elasticized arms, to avoid hindering progression. Equipped with two large-opening MGO connectors and a Bm'D connector with a CAPTIV positioning bar, it is certified to American, European and Russian standards.

ABSORBICA-Y TIE-BACK

Double lanyard with integrated intermediate tie-back rings and energy absorber

The ABSORBICA-Y TIE-BACK is a double lanyard with integrated intermediate tie-back rings and compact energy absorber. It is designed for vertical progression on very large structures and when passing intermediate anchor points. The TIE-BACK system allows the lanyard end to be reconnected to the intermediate tie-back ring to fit around structures with a very large cross-section. The arms are elasticized to avoid hindering progression. It is available with or without connectors and is certified to American, European and Russian standards.



Fall-arrest lanyards



ABSORBICA

Compact energy absorber

ABSORBICA is a compact energy absorber, for use in combination with a JANE lanyard to make a fall-arrest lanyard. Equipped with tear-webbing inside a pouch that opens on each end, the absorber is protected from abrasion, while allowing for regular inspection. It has two options for installation on the harness, according to the frequency of manipulation.

JANE-I

Single lanyard for making a fall-arrest lanyard

JANE-I is a non-adjustable dynamic rope lanyard that can be combined with an ABSORBICA energy absorber to make a single lanyard with energy absorber. The plastic sheath helps hold the carabiner in position and facilitates clipping while protecting the termination from abrasion. It can be used to set up a temporary anchor. It is available in three lengths: 60, 100 and 150 cm.

JANE-Y for fall-arrest lanyard

Double lanyard for making a fall-arrest lanyard

JANE-Y for fall-arrest lanyard is a non-adjustable dynamic rope lanyard that can be combined with an ABSORBICA energy absorber to make a double lanyard with energy absorber. The plastic sheaths help hold the carabiners in position and facilitate clipping while protecting the terminations from abrasion. It has two symmetrical ends and is available in two lengths: 60 and 100 cm.

Progression lanyards for rope access



PROGRESS ADJUST-Y

Double adjustable progression lanyard

PROGRESS ADJUST-Y is a double adjustable progression lanyard that enables continuous connection for all types of progression (rope ascent, moving along a traverse line...). Thanks to the ADJUST rope adjuster, the length of the adjustable arm can be quickly and easily adjusted. The TANGA accessory and the plastic sheath help hold the connectors in a good position for easy clipping.

PROGRESS ADJUST-I

Single adjustable progression lanyard

PROGRESS ADJUST-I is a single adjustable progression lanyard that allows, when combined with another lanyard, continuous connection for all types of progression (rope ascent, moving along a traverse line...). Thanks to the ADJUST rope adjuster, the length can be quickly and easily adjusted. Reversible, the ADJUST rope adjuster can be placed on the anchor or on the harness ventral attachment point. The CAPTIV ADJUST and STUART accessories help hold the connectors in a good position for easy clipping.

JANE-Y

Double progression lanyard

JANE-Y is a double progression lanyard that allows continuous connection during rope ascents. The plastic sheaths help hold the carabiners in position and facilitate clipping while protecting the terminations from abrasion. It has a 60 cm long arm and a 30 cm short arm.

Work positioning lanyard

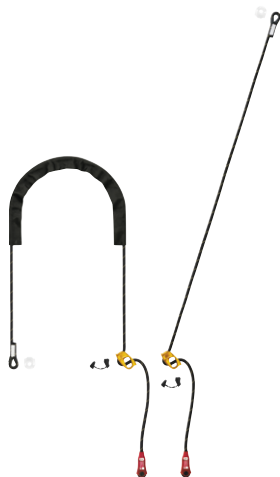

PROGRESS ADJUST-I

Adjustable positioning lanyard

When combined with a fall-arrest device, the PROGRESS ADJUST-I adjustable positioning lanyard enables comfortable positioning at a workstation when the user has support for his/her feet. Thanks to the ADJUST rope adjuster, the length can be quickly and easily adjusted. The CAPTIV ADJUST and STUART accessories help hold the connectors in a good position for easy clipping. Depending on the configuration, it can be used in single or double mode. The PROGRESS ADJUST-I positioning lanyard is available in three lengths (2, 3 and 5 m).

Tree care lanyards



ZILLON

Adjustable work positioning lanyard for tree care

The ZILLON work positioning lanyard for tree care adjusts easily with only one hand, even when loaded. It is designed for use in double mode on the harness side attachment points, or in single mode on the ventral attachment point with the hand on the free end. Yellow color for excellent visibility. ZILLON lanyard ropes are also available individually.

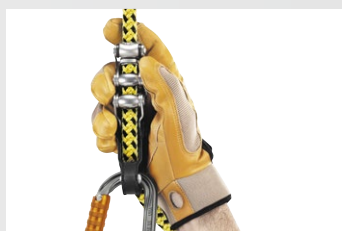

Easily adjusted with one hand, thanks to the progressive locking/unlocking action of the device.



Pulley mounted on sealed ball bearings allows slack to be taken up easily.



MICROFLIP

Reinforced adjustable positioning lanyard for tree care work

MICROFLIP is a reinforced adjustable lanyard designed for positioning in tree care work. Its cable core reduces the risk of severing the lanyard and facilitates moving about on the trunk. Yellow color for excellent visibility. MICROFLIP lanyard ropes are also available individually.



MICROGRAB

Replacement cam-loaded rope clamp for MICROFLIP

Replacement rope clamp for MICROFLIP, featuring an ergonomic cam and integrated cam spring.



Helivac lanyards



LEZARD

Helivac lanyard with securing of the drop-off/recovery phases

The LEZARD lanyard is designed for helivac at altitude. It allows the drop-off/recovery phases to be secured thanks to an adjustable arm that can be instantly ejected to free the victim, the rescuer and the helicopter if the latter needs to suddenly leave its stationary position. Operating the LEZARD helivac lanyard is easy thanks to the instant identification of the color-coded attachment elements and the very quick and precise adjustment of the adjustable arm with the ADJUST rope adjuster.



IGUANE

Helivac lanyard for ground drop-off/recovery

The IGUANE lanyard is designed for ground helivac. Easy operation thanks to the instant identification of the color-coded attachment elements. Lanyard available in two lengths.



The lower ends are equipped with STRING, which helps hold the carabiner in position and protects the webbing from wear.

Lanyard-end connectors



VERTIGO TWIST-LOCK

Connector for progression lanyard

See page 103 for details on the VERTIGO TWIST-LOCK connector.



EASHOOK OPEN

Connector with gated connection point for double lanyard and work positioning lanyard

See page 103 for details on the EASHOOK OPEN connector.



MGO OPEN

Auto-locking directional connector with large gate opening, and a gated connection point

See page 103 for details on the MGO OPEN connector.

		Lengths	Certifications	Weight
Work positioning lanyards and lanyards for rope access or tree care				
GRILLON	L052AA00/01/02/03/04/05/06	Adjustable to 2 m / 3 m / 4 m / 5 m / 10 m / 15 m / 20 m	ANSI Z359.3 CSA Z259.11 (1) CE EN 358 EN 12841 type C EAC	480 - 1875 g
	L052AA07/08 (black)	Adjustable to 2 m / 3 m		480 - 1875 g
GRILLON PLUS	L052EA00/01	Adjustable to 2 m / 3 m		435 - 515 g
GRILLON HOOK European version	L052BA00/01/02/03	Adjustable to 2 m / 3 m / 4 m / 5 m	CE EN 358 - EN 12841 type C - EAC	635 - 875 g
GRILLON HOOK international version	L052CA00/01/02/03		ANSI Z359.3 - CSA Z259.11 (1) CE EN 358 - EN 12841 type C - EAC	770 - 1010 g
GRILLON MGO	L052DA00/01	Adjustable to 2 m / 3 m	ANSI Z359.3 - CSA Z259.11 (1) CE EN 358 - EN 12841 type C - EAC	1220 - 1300 g
NEW 2021 JANE-Y	L051AA00	1 arm, 60 cm 1 arm, 30 cm	CE EN 354	130 g
PROGRESS ADJUST-Y	L044AA00	1 fixed arm, 65 cm 1 arm adjustable up to 95 cm	CE EN 358 EAC	230 g
PROGRESS ADJUST-I	L044BA00	1 arm adjustable up to 1 m	CE EN 358 ANSI Z359.3 CSA Z259.11 EAC	185 g
	L044BA01	1 arm adjustable up to 2 m		300 g
	L044BA02	1 arm adjustable up to 3 m		370 g
	L044BA03	1 arm adjustable up to 5 m		510 g
ZILLON	L22A 025/040/055	Adjustable to 2.5 m / 4 m / 5.5 m	CE EN 358	570 - 900 g
MICROFLIP	L33 025/040/055	Adjustable to 2.5 m / 4 m / 5.5 m	CE EN 358 - EAC	750 - 1355 g
MICROGRAB	B53A	-	CE EN 358 (2) - EN 567 - EAC NFPA 1983 Technical Use	150 g

		Connectors	Lengths without connectors	Lengths with connectors	Certifications	Weight
Fall-arrest lanyards						
ABSORBICA-I	L011AA00	-	80 cm	90 - 130 cm (depending on connectors)	CE EN 355 (4) ANSI Z359.13 12 feet (5) EAC	270 g
	L013AA01	-	150 cm	160 - 200 cm (depending on connectors)		320 g
ABSORBICA-I VARIO	L016AA00	-	100 - 150 cm	110 - 200 cm		280 g
ABSORBICA-Y	L012AA00	-	80 cm	90 - 130 cm (depending on connectors)	CE EN 355 (4) EAC	370 g
	L014AA01	-	150 cm	160 - 200 cm (depending on connectors)		430 g
ABSORBICA-Y MGO European version	L012CA00	Ends: 2 x MGO	80 cm	130 cm	CE EN 355 (4) EAC	1290 g
	L014CA01		150 cm	200 cm		1350 g
ABSORBICA-Y MGO international version	L012BA00	Ends: 2 x MGO - Bm'D	80 cm	110 cm	ANSI Z359.13 12 feet ANSI Z359.12 CE EN 355 EAC	1850 g
	L014BA01		150 cm	180 cm		1910 g
ABSORBICA-Y TIE-BACK	L015AA00	-	150 cm	160 - 200 cm (depending on connectors)	CE EN 355 (4) ANSI Z359.13 12 feet (5) EAC	550 g
	L015BA00	Ends: 2 x MGO - Bm'D		180 cm		2030 g
ABSORBICA	L010AA00	-	22 cm	-	CE EN 355 EAC	140 g
NEW 2021 JANE-I	L050BA00	-	60 cm	-	CE EN 354 EN 795 type B EAC ANSI Z359.3	100 g
	L050BA01	-	100 cm	-		120 g
	L050BA02	-	150 cm	-		145 g
NEW 2021 JANE-Y for fall arrest	L051AA02	-	60 cm	-	CE EN 354 ANSI Z359.3	145 g
	L051AA01	-	100 cm	-		185 g

		Connectors	Lengths	Certifications	Weight
Helivac lanyards					
LEZARD	L01	3 x VERTIGO TWIST-LOCK 1 x VERTIGO WIRE-LOCK	2 x 35 cm fixed arms, 1 ejectable arm, adjustable to 95 cm	CE	880 g
IGUANE	L001AA00	2 x VERTIGO TWIST-LOCK	2 x 25 cm fixed arms	CE EN 354	390 g
	L001AA01	1 x Am'D TWIST-LOCK	2 x 35 cm fixed arms		395 g

(1) for the 2 m version only, (2) with MICROFLIP, (3) maximum clearance, for factor 2 fall, see Instructions for Use at www.petzl.com for more details, (4) when used with EN 362 connectors, (5) when used with ANSI Z359.12 connectors.



MOBILE FALL ARRESTERS

Installed on a lifeline, mobile fall arresters follow the user automatically as s/he moves, whether on an inclined or vertical surface. In the event of a shock load or sudden acceleration, they lock onto the rope and stop the fall.



Mobile fall arresters

Installed on a safety rope, mobile fall arresters will lock in the event of a shock load or sudden acceleration.

- **For protection against falls**

Mobile fall arrester that can be combined (or not) with an ASAP'SORBBER or ASAP'SORBBER AXESS energy absorber.



ASAP

- **For protection against falls, with locking function**

Mobile fall arrester with locking function, used with an ASAP'SORBBER or ASAP'SORBBER AXESS energy absorber.



ASAP LOCK

Absorbers for mobile fall arresters

These energy absorbers are for use only with an ASAP or ASAP LOCK mobile fall arrester. They limit the impact force transmitted to the user in case of a fall.



ASAP'SORBBER



ASAP'SORBBER AXESS

Ropes for mobile fall arresters

Ropes with sewn terminations for use with ASAP and ASAP LOCK mobile fall arresters.



ASAP AXIS 11 mm



AXIS 11 mm
with sewn termination



RAY 11 mm
with sewn termination

NEW
2021



Installed on a safety rope, the ASAP and ASAP LOCK mobile fall arresters connect to the harness fall-arrest attachment point. They follow the user in his or her movements, and, in the event of a shock load or sudden acceleration, they lock and stop the fall.

• Constant fall protection

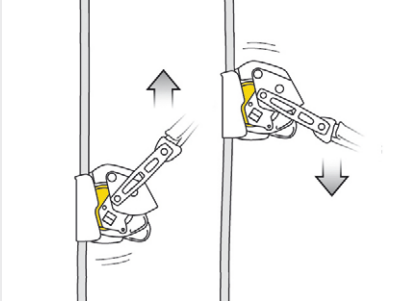

Integrated locking

In the event of a sudden movement due to a fall, slide or uncontrolled descent, the ASAP and ASAP LOCK mobile fall arresters lock on the rope and stop the worker's fall, even if s/he grabs the device with his/her hands.

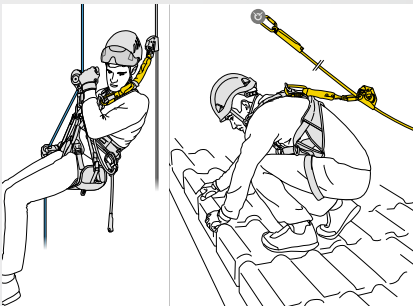

Effective in any situation

These mobile fall arresters work equally well on vertical or angled ropes, to adapt to any worksite situation.

• Simple to use



Quick installation

These mobile fall arresters may be quickly and easily installed anywhere on the rope by simply retracting the locking wheel.

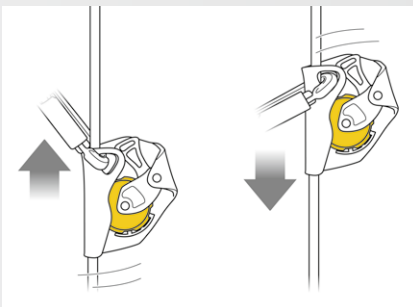

No user action required

The ASAP and ASAP LOCK mobile fall arresters follow the worker in all his/her movements, without the need for any manual operation. S/he can therefore focus completely on the task.



Compatible with all Petzl energy absorbers

To meet different user needs, the mobile fall arresters are compatible with all of the energy absorbers in the line: ASAP'SORBBER (20 and 40 cm) and ASAP'SORBBER AXESS.

• For fall protection

Depending on the use, the ASAP mobile fall arrester can be combined (or not) with an ASAP'SORBBER energy-absorber.

• For protection against falls, with locking function

The ASAP LOCK has a locking function allowing users to reduce the potential fall distance. Additionally, it is drop-resistant when passing intermediate anchors. It is used with an ASAP'SORBBER energy-absorber.





ASAP®

Mobile fall arrester for rope

With its unique locking system, the ASAP sets the standard in fall protection for workers at height. In normal use, the device moves freely along the rope without any manual intervention and follows the user in all his/her movements. In the event of a shock load or sudden acceleration, the ASAP locks on the rope and stops the user. Depending on the intended use, the ASAP may also be combined with an ASAP'SORBBER or ASAP'SORBBER AXESS energy absorber to work at a distance from the rope.



ASAP® LOCK

Mobile fall arrester with locking function

The ASAP LOCK mobile fall arrester is designed to facilitate handling during rope ascents. In normal use, the device moves freely along the rope without any manual intervention and follows the user in all his/her movements. In the event of a shock load or sudden acceleration, the fall arrester locks on the rope and stops the user. The integrated locking function allows the user to immobilize the device in order to reduce the potential fall distance. The connection arm makes the system drop-resistant when passing intermediate anchors. The ASAP LOCK is used with an ASAP'SORBBER or ASAP'SORBBER AXESS energy absorber to work at a distance from the rope.



Absorbers for mobile fall arresters



ASAP'SORBER

Energy absorber for ASAP and ASAP LOCK

The ASAP'SORBER energy absorber may only be used with an ASAP or ASAP LOCK mobile fall arrester. It allows the user to work at a distance from the rope, in order to protect it during certain work phases. Equipped with tear-webbing inside a pouch that opens on each end, the absorber is protected from abrasion, while allowing for regular inspection. It is available in two lengths, to provide the best balance between distance from the rope and reduced fall distance.



ASAP'SORBER AXESS

Energy absorber for an ASAP or ASAP LOCK for a maximum load of 250 kg

The ASAP'SORBER AXESS energy absorber may only be used with the ASAP or ASAP LOCK mobile fall arrester. It allows the user to work at a distance from the rope, in order to protect it during certain work phases. Equipped with tear-webbing inside a pouch that opens on each end, the absorber is protected from abrasion, while allowing for regular inspection. It can be used in two-person rescue situations for a maximum load of 250 kg.

Ropes for mobile fall arresters



ASAP'AXIS 11 mm

Low-stretch kernmantle rope with sewn termination and integrated energy dissipater, for use with an ASAP mobile fall arrester

The ASAP'AXIS 11 mm low-stretch kernmantle rope with sewn termination and integrated energy dissipater is designed for use with an ASAP mobile fall arrester. The energy dissipater is integrated with the rope and meets the requirements of the European EN 353-2 standard for fall protection. The standard diameter ensures a good grip for easier handling. EverFlex technology guarantees great flexibility and consistent performance over time. The sewn termination features the STUART accessory that helps keep the connector in position to facilitate handling. Rope available in six lengths.



AXIS 11 mm with sewn termination

Low-stretch kernmantle rope with sewn termination for use with an ASAP LOCK mobile fall arrester

The AXIS 11 mm low-stretch kernmantle rope with sewn termination is designed for use with an ASAP LOCK mobile fall arrester and an ASAP'SORBER or ASAP'SORBER AXESS energy absorber. It has a sewn termination with a protective sheath that helps keep the connector in position, allowing it to meet the requirements of the European EN 353-2 standard for fall protection. The standard diameter ensures a good grip for easier handling. EverFlex technology guarantees great flexibility and consistent performance over time. Rope available in six lengths.







NEW
2021



RAY 11 mm with sewn termination

Static rope with sewn termination for use with ASAP and ASAP LOCK mobile fall arresters

The RAY 11 mm static rope with sewn termination is designed for use with an ASAP or ASAP LOCK mobile fall arrester. It has low elongation under load, allowing it to meet the requirements of the ANSI Z359.15 American fall protection standard. The standard diameter ensures a good grip for easier handling. EverFlex technology guarantees great flexibility and consistent performance over time. The sewn termination with protective sheath helps keep the connector in position and facilitates handling. Rope available in five lengths.

		Certifications		Weight	
Mobile fall arresters					
ASAP		B070AA00	<p>ANSI Z359.15 when used with an ASAP'SORBBER or ASAP'SORBBER AXESS energy absorber, a Bm'D or OXAN TRIACT-LOCK (international version) carabiner, a CAPTIV positioning bar, and a RAY 11 mm static rope with sewn termination.</p> <p>CE EN 12841 type A when used with an OK TRIACT-LOCK carabiner and an EN 1891 type A 10-13 mm rope. An ASAP'SORBBER or ASAP'SORBBER AXESS energy absorber can be used when needed.</p> <p>CE EN 353-2 when used with an OK TRIACT-LOCK carabiner and an ASAP'AXIS 11 mm rope. An ASAP'SORBBER or ASAP'SORBBER AXESS energy absorber can be used when needed.</p> <p>EAC when used with an OK TRIACT-LOCK carabiner and an EN 1891 type A 10-13 mm rope. An ASAP'SORBBER or ASAP'SORBBER AXESS energy absorber can be used when needed.</p>	295 g	
ASAP LOCK		B071BA00	<p>ANSI Z359.15 when used with an ASAP'SORBBER or ASAP'SORBBER AXESS energy absorber, a Bm'D or OXAN TRIACT-LOCK (international version) carabiner, a CAPTIV positioning bar, and a RAY 11 mm static rope with sewn termination.</p> <p>CE EN 12841 type A when used with an ASAP'SORBBER or ASAP'SORBBER AXESS energy absorber and an EN 1891 type A 10 to 13 mm rope.</p> <p>CE EN 353-2 when used with an ASAP'SORBBER or ASAP'SORBBER AXESS energy absorber and an AXIS 11 mm rope with sewn termination.</p> <p>EAC when used with an ASAP'SORBBER or ASAP'SORBBER AXESS energy absorber and an EN 1891 type A 10 to 13 mm rope.</p>	425 g	
		Length	Certifications	Weight	
Absorbers for mobile fall arresters					
ASAP'SORBBER		L071AA00	ANSI Z359.13 6 feet CE EN 355 EAC	125 g	
		L071AA01		40 cm	145 g
ASAP'SORBBER AXESS		L071CB00	ANSI Z359.13 6 feet CE EN 355	205 g	
		Length	Certifications	Weight per meter	
Ropes for mobile fall arresters					
ASAP'AXIS 11 mm		R074DA00	CE EN 1891 type A	82 g	
		R074DA01			10 m
		R074DA02			20 m
		R074DA03			30 m
		R074DA04			40 m
		R074DA05			50 m
AXIS 11 mm with sewn termination		R074BA00	CE EN 1891 type A NFPA 1983 Technical Use EAC	82 g	
		R074BA01			10 m
		R074BA02			20 m
		R074BA03			30 m
		R074BA04			40 m
NEW 2021 RAY 11 mm with sewn termination		R100BA00	ANSI Z359.15 NFPA 1983 Technical Use CI 1801 EAC	98 g	
		R100BA01			25 ft
		R100BA02			50 ft
		R100BA03			75 ft
R100BA04	100 ft				



CONNECTORS

To address various situations encountered in the field, Petzl offers several types of connectors, with different shapes, sizes, gate openings and locking systems.



Evacuation exercise on the gondola lift in La Grave, France © 2020 - Petzl Distribution - Vuedici.org - SATG

To facilitate connection and disconnection, Petzl connectors have features that simplify their use.

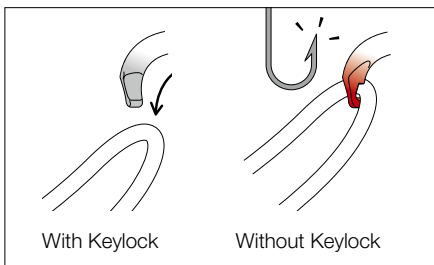

Avoids the risk of snagging

To ensure optimal efficiency, all Petzl carabiners use the Keylock system: the body/gate interface does not have a hook that could snag on anchors, ropes, harness gear loops...

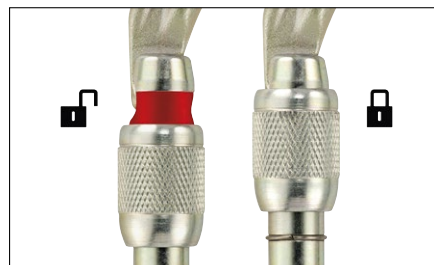

Visual locking indicator

To facilitate equipment checks, SCREW-LOCK manual locking carabiners have a red band that is visible only when the carabiner is not locked.

Lightweight carabiners

Aluminum carabiners designed for workers at height.



Ultra-lightweight carabiners

Compact aluminum carabiners for workers at height looking to reduce weight to a minimum.



High-strength carabiners

Carabiners suitable for difficult environments, primarily used for setting up anchors and for connecting to metal structures.



Lanyard-end connectors

Connectors designed for lanyard ends.



Special carabiners

Aluminum carabiners designed for specific uses: with groups, for additional braking with a descender, and for harness fastening.



Semi-permanent connectors

Connectors designed for semi-permanent connection of equipment.



Connector positioning accessories

Accessories that keep the carabiner correctly positioned in devices and at the end of a lanyard.



Lightweight carabiners

- Design facilitates handling

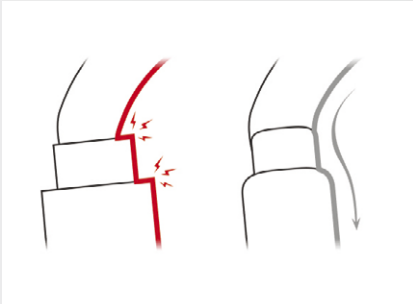

Fluid interior design

Fluid interior design limits the risk of having a catch point and facilitates rotation of the carabiner.



Optimal strength/weight ratio

The H cross-section ensures an optimal strength/weight ratio and protects the markings from abrasion.

- Multiple locking systems depending on the intensity of use:

- for frequent handling:

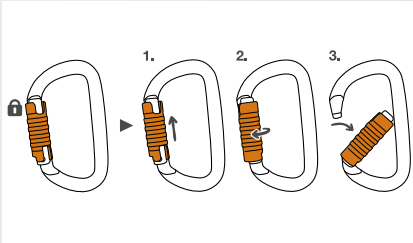

TRIACT-LOCK automatic system:

Unlocking is accomplished by raising, then turning the sleeve.

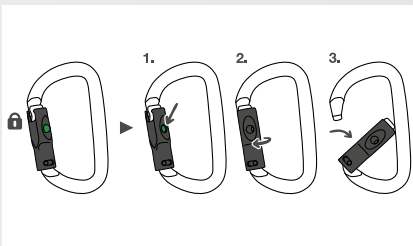

BALL-LOCK automatic system:

Unlocking is accomplished by pressing on the green indicator, then turning the sleeve. The green visual indicator is visible only when the gate is locked.

- for occasional handling:

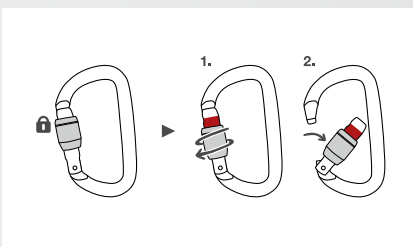

SCREW-LOCK manual system:

This system is suitable for harsh environments where contaminants (mud, ice) could cause an automatic locking system to jam. The red visual indicator is visible when the carabiner is unlocked.

- For connecting to equipment having a large cross-section



The OK carabiner has a symmetrical oval shape for optimal loading of devices with a large cross-section, such as pulleys, rope clamps or mobile fall arresters.

- For connection to equipment such as descenders or positioning lanyards



The Am'D carabiner has an asymmetrical D shape that is ideal for attaching equipment such as descenders or positioning lanyards.

- For connection of multiple items

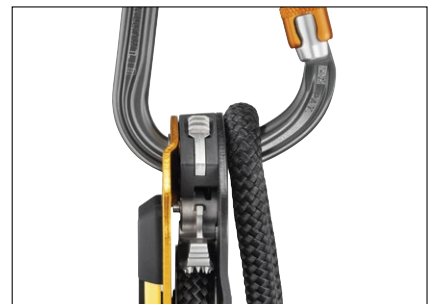

The WILLIAM has an asymmetrical pear shape, with a large capacity for attaching multiple elements, and a large gate opening to facilitate their installation.



OK Lightweight oval carabiner

The lightweight OK carabiner is made of aluminum. It has an oval shape that allows optimal loading of devices with a large cross-section, such as pulleys, rope clamps, and mobile fall arresters. Its fluid interior design and Keylock system facilitate handling. It is available in three locking systems: automatic TRIACT-LOCK or BALL-LOCK, or manual SCREW-LOCK. OK can be used with the CAPTIV bar to promote loading of the carabiner on the major axis, to limit the risk of rotation and to keep it integrated with the device.



Am'D Lightweight asymmetrical carabiner

The Am'D lightweight asymmetrical carabiner is made of aluminum. It has a D shape particularly suited for connection to diverse equipment such as descenders or positioning lanyards. Its fluid interior design and Keylock system facilitate handling. The Am'D carabiner is available in three locking systems: automatic TRIACT-LOCK or BALL-LOCK system, or manual SCREW-LOCK system. Am'D may be used with a CAPTIV positioning bar to favor loading of the carabiner along the major axis, to limit the risk of rotation and to keep it integrated with the device.



WILLIAM Lightweight asymmetrical large-capacity carabiner

The lightweight WILLIAM large-capacity asymmetrical carabiner is made of aluminum. The pear shape makes it easy to attach multiple items. Its fluid interior design and Keylock system facilitate handling. The WILLIAM carabiner is available in three locking systems: automatic TRIACT-LOCK or BALL-LOCK, or manual SCREW-LOCK. WILLIAM can be used with the CAPTIV bar to favor positioning of the carabiner along the major axis, to limit the risk of rotation and to keep it integrated with the device.



Ultra-lightweight carabiners



Sm'D

Ultra-lightweight asymmetrical carabiner

The compact Sm'D asymmetrical aluminum carabiner is recommended for workers at height looking to reduce weight to a minimum. The D shape makes it especially suitable for attaching devices. It is available in two locking systems (automatic TRIACT-LOCK system or manual SCREW-LOCK system), or without a locking system.

High-strength carabiners



OXAN

High-strength oval carabiner

OXAN is a high-strength steel carabiner designed for use in harsh environments. The oval, symmetrical shape allows optimal loading of the carabiner when setting up anchors or connecting to metal structures. It is available in two locking systems: automatic TRIACT-LOCK system or manual SCREW-LOCK system. OXAN TRIACT-LOCK is available in European or international versions. OXAN can be used with the CAPTIV bar to favor positioning of the carabiner along the major axis, to limit the risk of rotation and to keep it integrated with the device.

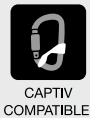

The oval, symmetrical shape allows optimal loading of the carabiner when setting up anchors. Usage with the CAPTIV positioning bar favors loading of the carabiner along the major axis, limits the risk of rotation and keeps it attached to the device or lanyard.



CAPTIV
COMPATIBLE

VULCAN

High-strength, large-capacity asymmetrical carabiner

VULCAN is a high-strength steel carabiner designed for use in harsh environments. The large-capacity asymmetrical shape is ideal for setting multiple anchors. The VULCAN carabiner is available in two locking systems: automatic TRIACT-LOCK system or manual SCREW-LOCK system. VULCAN TRIACT-LOCK is available in European or international versions. VULCAN can be used with the CAPTIV bar to promote loading of the carabiner on the major axis, to limit the risk of rotation and to keep it integrated with the device.

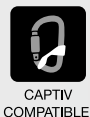

CAPTIV
COMPATIBLE

Bm'D

Lightweight asymmetrical high-strength carabiner

The Bm'D lightweight asymmetrical carabiner is made of aluminum. It has a D shape particularly suited for connection to diverse equipment such as descenders or positioning lanyards. Its fluid interior design and Keylock system facilitate handling. The Bm'D carabiner has the TRIACT-LOCK automatic locking system. The sleeve is reinforced for greater inward and lateral gate strength. Bm'D may be used with a CAPTIV positioning bar to promote loading of the carabiner on the major axis, to limit the risk of rotation and to keep it integrated with the device.

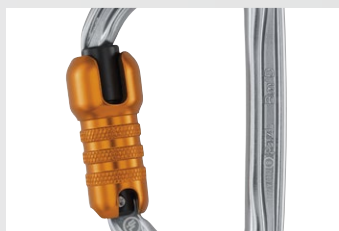

The sleeve is reinforced for greater inward and lateral gate strength.

Semi-permanent connectors



RING OPEN

Multidirectional gated ring

The RING OPEN gated ring is designed for semi-permanent connection of equipment. Its round shape ensures optimal functioning in all directions. It has a large opening that allows installation of ropes with sewn terminations.



DELTA

Triangular steel quick link

When closed with a wrench, this steel quick link becomes a semi-permanent anchor ring.



GO

Oval steel quick link

When closed with a wrench, this steel quick link becomes a semi-permanent anchor ring.



DEMI ROND

Semi-circle aluminum alloy quick link

When closed with a wrench, this aluminum quick link is used to fasten harnesses that have two attachment points that must be joined with a connector.

Connector positioning accessories



CAPTIV

Connector positioning bar (pack of 10)

The CAPTIV positioning bar promotes loading of the carabiner on the major axis, limits the risk of rotation and keeps it integrated with the device or lanyard. CAPTIV is compatible with OK, Am'D, WILLIAM, OXAN, VULCAN, Bm'D carabiners and the ROLLCLIP A pulley carabiner.



CAPTIVO

Positioning bar for the VERTIGO TWIST-LOCK connector (pack of 10)

The CAPTIVO positioning bar secures the connector to the lanyard, promotes loading of the connector on the major axis and limits the risk of rotation. CAPTIVO is only compatible with the VERTIGO TWIST-LOCK connector.



CAPTIV ADJUST

Carabiner positioning bar combined with an ADJUST rope adjuster

The CAPTIV ADJUST positioning bar promotes loading of the carabiner on the major axis and helps hold the ADJUST rope adjuster in the proper position to reduce the risk of accidental release. It helps keep the lanyard and rope adjuster integrated with the carabiner, reducing the risk of losing them. CAPTIV ADJUST is compatible with OK, Am'D, Bm'D and OXAN carabiners.



STUART

Connector positioning accessory (pack of 10)

STUART helps keep the connector in the correct position and facilitates clipping. It is compatible with most auto-locking connectors.



TANGA

Connector positioning ring (pack of 10)

The TANGA positioning ring helps hold the connector in the correct position.



STRING

Accessory for maintaining connector orientation and protecting the webbing (pack of 10)

STRING helps maintain the proper orientation of the connector and protects the webbing from wear. It is available in two sizes.

DESCENDERS

Descenders are designed to help regulate friction and control the descent on a fixed rope. They allow a worker to position him/herself at any point on the rope. Certain Petzl descenders can also be used as belay devices.



Technical rescue training with GRIMP 30, Nîmes, France © 2020 - Petzl Distribution - Vuedici.org - GRIMP 30 - VATEL

Self-braking descenders

Self-braking descenders with ergonomic handle and AUTO-LOCK system allow a comfortably controlled descent and easy positioning at the workstation. These devices are designed for work at height, rope access, and technical rescue and evacuation.



Descenders for technical rescue

Descenders with integrated progress-capture pulley and AUTO-LOCK system to facilitate lowering and raising heavy loads.



Mechanical Prusiks for tree care

Mechanical Prusiks allow the user to move around efficiently in a tree while benefiting from the handling of a classic Prusik pulley system.



Standard descenders

Descenders with a simple design, using the friction between the rope and the device to brake a descent. The speed of the descent is regulated by varying the grip on the free end of the rope.

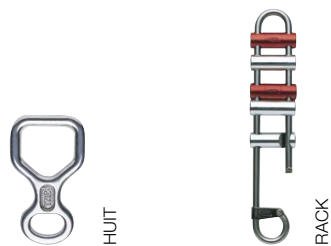

Personal escape system

Rescue device that allows a single person to get him/herself out of a building or structure in the event of an emergency. It has a multipurpose anchor hook adapted for locations where the possibility of finding an anchor point is uncertain.



Self-braking descenders

Easy to use, self-braking descenders adapt to any situation encountered during work at height, rope access work, or technical rescue: descending, work positioning, short rope ascents, belaying with climbing techniques.

• Easy to use

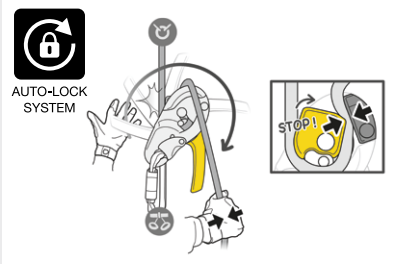

AUTO-LOCK system

The AUTO-LOCK system allows users to easily position themselves at a workstation without having to manipulate the handle or tie off the device: as soon as the user releases the handle, the rope is automatically locked in the device.



Installing the rope

The device has a safety gate on the moving side plate that allows the rope to be easily installed, while the device remains connected to the harness.



Comfortable, controlled descent

The ergonomic handle allows unlocking the rope and comfortably controlling the descent. Two descent modes are possible: on the side plate or in the V-shaped friction channel.

• Versatile

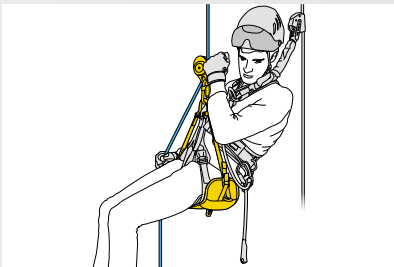

Self-braking descenders are versatile and can be used for both descents and short rope ascents.

• Wear resistance



The stainless steel wear plate improves durability by reinforcing the rope friction zone.

• With anti-panic function and anti-error catch

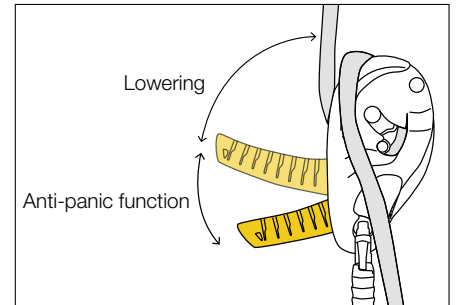

Designed for work at height, rope access, and technical rescue and evacuation, these devices are equipped with an anti-panic function and an anti-error catch, to reduce the risk of an accident due to user error. They are also compatible with auxiliary brakes, which help increase the friction for lowering heavy loads.

• Compact and lightweight



The RIG descender is compact and lightweight, and designed for experienced rope access workers.



I'D® S

Self-braking descender with anti-panic function for work at height and rope access work

The self-braking I'D S descender is primarily designed for work at height and rope access work. It has an ergonomic handle that allows comfortable descent control. The integrated anti-panic function and anti-error catch reduce the risk of an accident due to user error. The AUTO-LOCK system allows users to easily position themselves at the workstation without having to manipulate the handle or tie off the device. Once locked, the rope can be taken up without having to manipulate the handle. The safety gate allows the rope to be installed with the device remaining connected to the harness. I'D S is compatible with 10 to 11.5 mm ropes and allows handling of loads up to 250 kg.



I'D® L

Self-braking descender with anti-panic function for rescue

The I'D L self-braking descender is primarily designed for rescue. It has an ergonomic handle that allows comfortable descent control. The integrated anti-panic function and anti-error catch reduce the risk of an accident due to user error. The AUTO-LOCK system allows users to position themselves without having to manipulate the handle or tie off the device. Once locked, the rope can be taken up without having to manipulate the handle. The safety gate allows the rope to be installed with the device remaining connected to the harness. I'D L is compatible with 12.5 to 13 mm ropes and allows handling of loads up to 280 kg.



I'D® EVAC

Self-braking descender with anti-panic function for lowering from an anchor

The I'D EVAC self-braking descender is primarily designed for lowering from an anchor. The ergonomic handle is specifically oriented for managing a load from the anchor and offers comfortable descent control. The integrated anti-panic function and anti-error catch reduce the risk of an accident due to user error. The AUTO-LOCK system allows the rope to be automatically locked without having to manipulate the handle or tie off the device. Once locked, the rope can be taken up without having to manipulate the handle. The safety gate allows the rope to be installed with the device remaining connected to the anchor. I'D EVAC is compatible with 10 to 11.5 mm ropes and allows handling of loads up to 250 kg.

Accessories



Open auxiliary brake for I'D®

Open auxiliary brake for I'D S, I'D L and I'D EVAC self-braking descenders

The open auxiliary brake is designed for I'D self-braking descenders. It is used to add friction depending on the load and rope diameter, and allows the rope to be inserted or removed at any time.



Closed auxiliary brake for I'D®

Closed auxiliary brake for I'D S, I'D L and I'D EVAC self-braking descenders

The closed auxiliary brake is designed for I'D self-braking descenders. It is used to add friction depending on the load and rope diameter and provides a constant redirect of the rope.



RIG®

Compact self-braking descender for rope access, designed for experienced users

RIG is a compact self-braking descender for rope access, designed for experienced users. It has an ergonomic handle that allows comfortable descent control. The AUTO-LOCK system allows users to easily position themselves at the workstation without having to manipulate the handle or tie off the device. Once locked, the rope can be taken up without having to manipulate the handle. The safety gate allows the rope to be installed with the device remaining connected to the harness.



Descenders for technical rescue

These descenders offer the versatility required for technical rescue operations: lowering, hauling, handling heavy loads, use in the primary system or in a back-up belay...

- **Easy rope installation**



Rope installation is quick and easy, thanks to the markings on the device.

- **Comfortable, controlled descent, even with heavy loads**



The ergonomic handle and integrated brake enable a comfortably controlled descent.



The faceted sheave creates additional friction zones for the rope and thus provides extra braking for lowering heavy loads.

- **Excellent hauling efficiency**

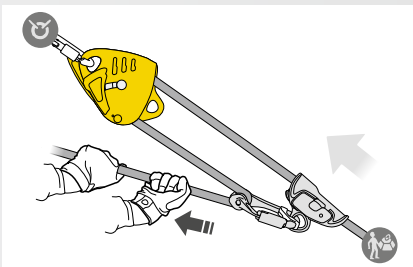

The integrated progress-capture pulley with very large diameter sheave mounted on sealed ball bearings rotates in only one direction for excellent hauling efficiency. The lower connection point can be used to create different types of haul systems.

- **AUTO-LOCK system: automatically locks the rope**

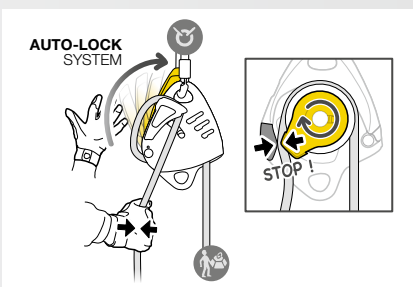

The AUTO-LOCK system allows automatic locking of the rope when the handle is not in use. Once locked, the rope can be taken up without having to manipulate the handle.

MAESTRO S

Ø 10.5 to 11.5 mm

250 kg

MAESTRO L

Ø 12.5 to 13 mm

280 kg

Mechanical Prusiks for tree care

Mechanical Prusiks allow arborists to optimize their movement within a tree. They are user-friendly and intuitive to use. To meet a variety of needs, they can be used on doubled ropes or a single rope.

- **Intuitive to use**



The technique is identical to that of a classic Prusik pulley system, offering immediate usability. The device locks automatically once the friction chain is extended.

- **For efficient movement**



- **Smooth, precise rope feed**

The release lever is mounted on a spring, for great precision when moving around. Adjusting the pressure on this lever controls the speed of movement.

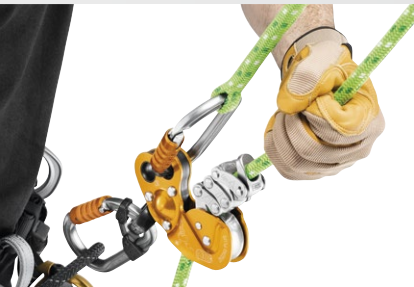

- **Slack easily taken up**

The pulley is mounted on sealed ball bearings to allow the slack to be taken up easily when moving around. The widely spaced side plates also contribute to smooth rope glide.

- **Versatile**



- **Use on doubled ropes**

ZIGZAG and ZIGZAG PLUS allow use on doubled ropes.

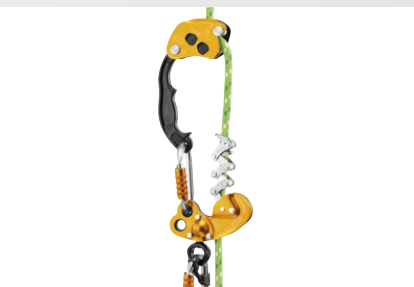

- **Use on a single rope**

They can also be used on a single rope, thanks to the CHICANE accessory, which offers more friction on the descent, and the KNEE ASCENT assemblies, which facilitate the ascent.

- **Standard version**



The lower attachment hole is fixed to ensure alignment of the device with the axis of the worker and to optimize grip.

- **Version with high-efficiency swivel**



The lower attachment hole with high-efficiency swivel ensures stable and correct positioning of the mechanical Prusik and optimal rope glide through the device.



ZIGZAG®

Mechanical Prusik for tree care

The ZIGZAG mechanical Prusik allows the user to move around efficiently in a tree using classic Prusik pulley system technique. The friction chain provides precision and fluidity when moving around. The pulley is mounted on sealed ball bearings to allow the slack to be taken up easily. Can be used on either doubled ropes or a single rope, providing great versatility. The lower attachment hole is fixed to ensure alignment of the device with the axis of the worker and to optimize grip.



ZIGZAG® PLUS

Mechanical Prusik with high-efficiency swivel, for tree care

The ZIGZAG PLUS mechanical Prusik allows the user to move around efficiently in a tree using classic Prusik pulley system technique. The friction chain provides precision and fluidity when moving around. The pulley is mounted on sealed ball bearings to allow the slack to be taken up easily. Can be used on either doubled ropes or a single rope, providing great versatility. The lower attachment hole with high-efficiency swivel ensures stable and correct positioning of the mechanical Prusik and optimal rope glide through the device.

Accessory



CHICANE

Auxiliary brake for mechanical Prusik on single ropes, for tree care

The CHICANE auxiliary braking device allows ZIGZAG and ZIGZAG PLUS mechanical Prusiks to be used on single ropes. It provides continuous additional friction on descents. The excellent compatibility of the CHICANE and mechanical Prusik as an assembled unit ensures smooth rope glide through the brake during ascents. The ergonomic handle provides excellent grip and facilitates movement while limb walking. Thanks to the openable side plate, installation is quick and easy.

Descenders

Standard descenders



HUIT

Figure-eight descender

Figure-eight descender, compact and lightweight. Square shape helps reduce rope twist.



RACK

Variable friction descender with brake bars

The design and configuration of the RACK bars make it easy to set up and insert the rope. Compact and lightweight, the device allows the user to adjust the amount of friction during the descent, to adapt to changing conditions.

Personal escape system

EXO[®] AP HOOK

Personal escape system with anchor hook

EXO AP HOOK is a personal escape system with a HOOK anchor hook, adapted for situations where the possibility of finding an anchor point is uncertain. It has a self-braking system with anti-panic function for quickly moving horizontally, climbing through a window and controlling and stopping a descent. If the user pulls too hard on the handle, the anti-panic function brakes and stops the descent automatically. EXO AP HOOK also includes a rope that resists wear and high temperatures, an Am'D connector with CAPTIV positioning bar, and a bag for transporting and attaching the system directly to the harness. Other rope lengths and other types of connectors (EASHOOK OPEN...) are available by special order.

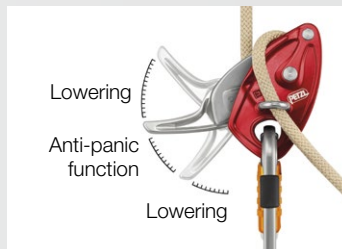

If the user pulls too hard on the handle, the anti-panic function brakes and stops the descent automatically.



The anchor hook may be used around a structure, secured with a locking hitch.

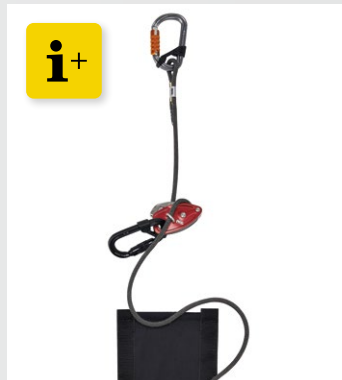

CUSTOM

Petzl Custom service allows you to choose:

- type of rope: standard or high-strength rope
- rope color
- rope length
- type of rope-end connectors and harness connector

The assembly of various components of your choice offers a ready-made solution specific to the user, delivered in a transport pouch or bag adapted to the length of the rope.

EXO CUSTOM: D030YXXX

Because of the unique shape of the anchor hook, special Petzl training for the EXO AP HOOK is mandatory.

			Certifications	Rope diameter compatibility	Maximum working load	Weight	
Self-braking descenders							
I'D S		D020AA00 (yellow) D020AA01 (black)	EN 341 type 2 class A (1) CE EN 12841 type C (2) CE EN 15151-1 (3) ANSI Z359.4 (4) NFPA 1983 Technical Use (5) EAC	10 to 11.5 mm	Lowering a heavy load up to 250 kg	600 g	
I'D L		D020BA00 (red) D020BA01 (black)	EN 341 type 2 class A (6) CE EN 12841 type C (7) ANSI Z359.4 (8) NFPA 1983 General Use (9) EAC	12.5 to 13 mm	Lowering a heavy load up to 280 kg	600 g	
I'D EVAC		D020CA00 (yellow) D020CA01 (black)	EN 341 type 2 class A (1) CE EN 12841 type C (2) ANSI Z359.4 (4) NFPA 1983 Technical Use (5) EAC	10 to 11.5 mm	Lowering a heavy load up to 250 kg	615 g	
RIG		D021AA00 (yellow) D021AA01 (black)	CE EN 12841 type C (2) EN 341 type 2 class A (1) CE EN 15151-1 (10) NFPA 1983 Technical Use (5) EAC	10 to 11.5 mm	Lowering a heavy load up to 200 kg	400 g	
Open auxiliary brake for I'D		D020DA00	-	-	-	20 g	
Closed auxiliary brake for I'D		D020EA00	-	-	-	20 g	
Rescue descenders							
MAESTRO S		D024AA00	CE EN 12841 type C EN 341 NFPA 1983 Technical Use EAC	10.5 to 11.5 mm	Lowering a heavy load up to 250 kg	1100 g	
MAESTRO L		D024BA00	CE EN 12841 type C EN 341 NFPA 1983 General Use EAC	12.5 to 13 mm	Lowering a heavy load up to 280 kg	1100 g	
Mechanical Prusiks for tree care							
ZIGZAG		D022AA00	CE	11.5 to 13 mm	140 kg	365 g	
ZIGZAG PLUS		D022BA00	CE	11.5 to 13 mm	140 kg	425 g	
CHICANE		D022CA00	CE (with ZIGZAG or ZIGZAG PLUS mechanical Prusik)	11.5 to 13 mm	140 kg	255 g	
Standard descenders							
HUIT		D02	-	8 to 13 mm (single and doubled rope)	100 kg	100 g	
RACK		D11	-	9 to 13 mm (single rope) 8 to 11 mm (doubled rope)	100 kg	470 g	
Personal escape system							
EXO AP HOOK		D031DA00	NFPA 1983 Escape Use	7.5 mm (EXO rope only)	140 kg	1470 g	

(1) EN 341 type 2 class A when used with a PARALLEL 10.5 mm or AXIS 11 mm rope
 (2) EN 12841 type C when used with a 10 to 11.5 mm EN 1891 A rope
 (3) EN 15151-1 when used with a 10 to 11 mm rope
 (4) ANSI Z359.4 when used with a 10 to 11.5 mm rope
 (5) NFPA 1983 Technical Use when used with a 10 to 11.5 mm rope

(6) EN 341 type 2 class A when used with a VECTOR 12.5 mm rope
 (7) EN 12841 type C when used with a 12.5 to 13 mm EN 1891 A rope
 (8) ANSI Z359.4 when used with a 12.5 to 13 mm rope
 (9) NFPA Technical Use when used with a 12.5 to 13 mm rope
 (10) EN 15151-1 when used with a 9 to 11 mm rope



ROPE CLAMPS

Rope clamps are primarily used for progression on ropes and for setting up haul systems.



Building construction, Paris la Défense, France © 2019 - Petzl Distribution - Lafouche - Integral - Bateg - Tour Trinity - Cro&Co Architecture



Optimal locking

Petzl's frame-loaded rope clamps are designed to function optimally under any conditions (wet, frozen, dirty ropes, for example). They are therefore equipped with a special stainless steel cam. Its unique design, the shape of its teeth and its self-cleaning slot allow optimal grip on the rope without damaging it, while reducing the effort required to slide the device up the rope.

Rope clamps for progression

Frame-loaded rope clamps are easy to install and specially designed for rope ascents (handled rope clamps, ventral rope clamps and foot-mounted rope clamps).



Versatile rope clamp

Rope clamp that can be used to ascend a fixed rope, or as progress capture in a haul system.



Backup rope clamp

Ultra-compact, lightweight rope clamp for occasional rope ascents and haul systems.



Cam-loaded rope clamp

Rope clamp designed for use in haul systems as a tractor or progress capture device.



Rope clamps

Rope clamps for progression



ASCENSION
left-handed

ASCENSION
right-handed

ASCENSION

Handled rope clamp for rope ascents

The ASCENSION handled rope clamp is designed for rope ascents and features an overmolded grip and ergonomic upper part for a comfortable and powerful grip when pulling with one or two hands. The ASCENSION handled rope clamp has a large lower hole for easily attaching two carabiners for a lanyard and foot loop.



The overmolded dual-density grip has an area for the index finger and a wide, supportive base to keep the hand from slipping. Ergonomic upper part maximizes power when pulling with two hands.



PROGRESS ADJUST-Y

Double adjustable progression lanyard

Find a description of the PROGRESS ADJUST-Y lanyard on page 88.



FOOTAPE

Adjustable webbing foot loop

The adjustable FOOTAPE foot loop is used with an ASCENSION or BASIC rope clamp for rope ascents. A height-adjustable elastic keeps the foot in the loop, regardless of shoe type.

FOOTCORD

Adjustable cord foot loop

The adjustable FOOTCORD foot loop is used with an ASCENSION or BASIC rope clamp for rope ascents. Its high-modulus polyethylene construction increases durability. A height-adjustable elastic keeps the foot in the loop, regardless of shoe type.

LOOPING

Four-step etrier

The LOOPING four-step etrier attaches to an ASCENSION rope clamp for rope ascents or directly onto an anchor for progression in overhangs.



CROLL®

Ventral rope clamp

Designed for rope ascents, the CROLL ventral rope clamp is simple to use, thanks to its pinch opening system, which is totally integrated in the clamp to avoid any involuntary snagging. The attachment holes ensure efficient positioning during ascents. It is available in two versions to adapt to different rope diameters.



SECUR

Shoulder straps for positioning the CROLL ventral rope clamp

SECUR shoulder straps position the CROLL ventral rope clamp and attach to AVAO SIT, FALCON, FALCON ASCENT and SEQUOIA SRT harnesses.



ASCENTREE

Double-handled rope clamp for tree care

Handled rope clamp designed for doubled rope ascents, the ASCENTREE has ergonomic handles allowing a comfortable and powerful grip when pulling. Catch/cam unit is totally integrated to prevent any involuntary snagging.



PANTIN
left-foot

PANTIN
right-foot

PANTIN®

Foot-mounted rope clamp

The PANTIN foot-mounted rope clamp is used with the CROLL, ASCENSION or ASCENTREE rope clamps to make rope ascents faster and less tiring. It is available in right- and left-foot versions.

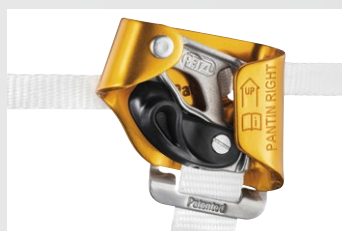

Catch available as accessory to keep the rope in the device during rope ascents.



KNEE ASCENT LOOP

Knee ascender assembly with foot loop to facilitate ascents on a single rope, for tree care

The KNEE ASCENT LOOP assembly facilitates the arborist's ascent when using the ZIGZAG or ZIGZAG PLUS mechanical Prusik on a single rope. It contains an upper strap, a CROLL L rope clamp, a lower strap with foot loop and an XS size TOOLBAG tool pouch. The system is fully adjustable and adapts to all body types. All components are available separately.

KNEE ASCENT CLIP

Knee ascender assembly with boot connector, facilitating single rope ascents, for tree care

The KNEE ASCENT CLIP assembly facilitates the arborist's ascent when using the ZIGZAG or ZIGZAG PLUS mechanical Prusik on a single rope. It contains an upper strap, a CROLL L rope clamp, a lower strap with connector that attaches to the sewn webbing on the top of the arborist's boot, and an XS size TOOLBAG tool pouch. The system is fully adjustable and adapts to all body types. All components are available separately.



Rope clamps

Versatile rope clamp



BASIC

Compact, versatile rope clamp

The BASIC rope clamp is very compact, making it easy to grip. The large lower hole allows lanyard and foot loop carabiners to be easily connected.

Backup rope clamp



TIBLOC

Backup rope clamp

Extremely compact and lightweight, the TIBLOC is a backup rope clamp for ascending ropes or setting up haul systems.

Cam-loaded rope clamp



RESCUCENDER

Openable cam-loaded rope clamp

Simple to use and ergonomic, the RESCUCENDER is an openable cam-loaded rope clamp designed for use in haul systems as a tractor or progress capture device.



Openable guided cam allows easy installation or removal of the rope clamp at any point on the rope.

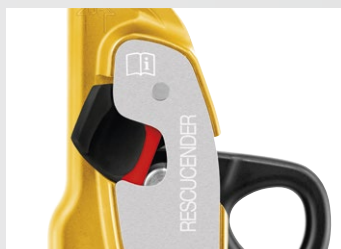

The safety catches are equipped with indicators that show when they are unlocked.

			Certifications	Rope diameter compatibility	Weight
Rope clamps for progression					
ASCENSION		B17ALA (left-handed, black/yellow) B17ALN (left-handed, black) B17ARA (right-handed, black/yellow) B17ARN (right-handed, black)	CE EN 567 CE EN 12841 type B NFPA 1983 Technical Use EAC	8 to 13 mm	165 g
FOOTAPE		C47A	-	-	65 g
FOOTCORD		C48A	-	-	40 g
LOOPING		C25	-	-	145 g
CROLL S		B16BAA	CE EN 567 CE EN 12841 type B EAC NFPA 1983 Technical Use	8 to 11 mm	85 g
CROLL L		B016AA00	CE EN 567 CE EN 12841 type B EAC NFPA 1983 Technical Use	8 to 13 mm	140 g
SECUR		C74A	-	-	135 g
ASCENTREE		B19AAA	CE	8 to 13 mm	330 g
PANTIN		B02CLA (left foot) B02CRA (right foot)	The PANTIN is not an item of PPE	8 to 13 mm	85 g
Catch for PANTIN		B02210 (for left foot PANTIN) B02200 (for right foot PANTIN)	-	-	25 g
KNEE ASCENT LOOP		D022DA00	-	11.5 to 13 mm	280 g
KNEE ASCENT CLIP		D022EA00	-	11.5 to 13 mm	285 g
Versatile rope clamp					
BASIC		B18BAA	CE EN 567 CE EN 12841 type B EAC	8 to 11 mm	85 g
Backup rope clamp					
TIBLOC		B01BN	CE EN 567 EAC	8 to 11 mm	35 g
Cam-loaded rope clamp					
RESCUCENDER		B50A	CE EN 567 CE EN 12841 type B NFPA 1983 Technical Use EAC	9 to 13 mm (1) 10 to 13 mm (2)	260 g

(1) for the CE EN 567 standard, (2) for the other standards.



PULLEYS

Pulleys are used for raising equipment, and for making haul systems in a rescue situation. Some of them can be combined with a rope clamp to facilitate maneuvers; others allow movement along rope or cable.



Technical rescue training with GRIMP 30, Nîmes, France © 2020 - Petzl Distribution - Vuedici.org - GRIMP 30 - VATEL

Two factors determine a pulley's efficiency:

- Sheave size: the larger the sheave diameter, the higher the efficiency
- Bushings and bearings:
 - self-lubricating bushings are efficient, but they must be regularly maintained
 - sealed ball bearings are very efficient, and they do not require any maintenance



High-efficiency pulleys with swivel

High-performance pulleys equipped with a swivel, making them drop-resistant while installing the rope.



High-efficiency pulleys

Versatile, high-performance pulleys adapted for intensive use.



Pulley-carabiners

Pulley-carabiners with excellent efficiency.



Progress-capture pulleys

Pulleys with an integrated progress capture system may be used to replace a traditional pulley/rope clamp setup in haul systems.



Prusik pulleys

High-performance pulleys designed for use with a Prusik friction hitch to build a lightweight progress capture system. The shape of the side plates allows the knot to be released when it stops against the pulley.



Single pulleys

Lightweight, versatile pulleys designed for situations that do not require a high level of efficiency (redirecting the rope...).



Transport pulleys

Pulleys designed for movement along a rope or cable.



Haul kit

Ready-to-use kit, designed to easily pick off and lower - or simply pick off - a victim.



High-efficiency pulleys with swivel

NEW
2021



SPIN L1

Very high efficiency single pulley with swivel

Openable even when attached to the anchor, the SPIN L1 pulley is designed for maximum simplicity in setting up haul or load deviation systems and Tyroleans. The large-diameter sheave mounted on sealed ball bearings gives it excellent efficiency. The swivel facilitates handling, allowing the pulley to be oriented under load and to directly connect carabiners, ropes or slings.



Triple-action opening of the moving side plate is quick and easy, even with gloves.

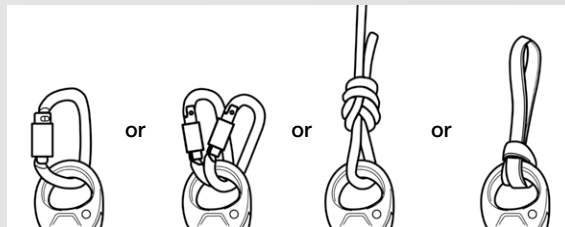

The swivel accepts up to three carabiners and allows the use of ropes and slings to facilitate maneuvers.

NEW
2021



SPIN L2

Very high efficiency double pulley with swivel

Openable even when attached to the anchor, the SPIN L2 is a double pulley designed for maximum simplicity when setting up haul systems or Tyroleans. The two parallel-mounted sheaves and auxiliary attachment point allow the pulley to be used to set up various types of complex haul systems. The large-diameter sheaves mounted on sealed ball bearings provide excellent efficiency. The swivel facilitates handling, allowing the pulley to be oriented under load and to directly connect carabiners, ropes or slings.

NEW
2021



SPIN L1D

Very high efficiency single pulley with one-way rotation and swivel

Openable even when attached to the anchor, the SPIN L1D pulley is designed to be used in conjunction with a descender for maximum simplicity when setting up a deviation for a heavy load. The faceted sheave only rotates in one direction, providing excellent efficiency when hauling, and adding friction zones for the rope for additional braking when lowering. The swivel facilitates handling, allowing the pulley to be oriented under load and to directly connect carabiners, ropes or slings.

High-efficiency pulleys



PARTNER

Ultra-compact, high-efficiency pulley

The PARTNER is an ultra compact, extremely lightweight pulley. It is designed for daily tasks and on-site rescue.



RESCUE

High strength, very high efficiency pulley

The very high efficiency RESCUE pulley is designed for intensive use by rescue professionals.

Pulley-carabiners



ROLLCLIP A

Pulley-carabiner that facilitates installation of the rope when pulley is connected to the anchor

ROLLCLIP A is a pulley-carabiner with the gate opening on the pulley end, to facilitate rope installation when the pulley is fixed to the anchor. It is available with an automatic TRIACT-LOCK locking system, or without a locking system. ROLLCLIP A may be used with a CAPTIV positioning bar to promote loading of the carabiner on the major axis, to limit the risk of rotation and to keep it integrated with the device.



ROLLCLIP Z

Pulley-carabiner that facilitates installation on anchors and devices

ROLLCLIP Z is a pulley-carabiner with the gate opening on the non-pulley end, to facilitate installation on anchors and devices. It is available in two locking systems: automatic TRIACT-LOCK system or manual SCREW-LOCK system.

Progress-capture pulleys



PRO TRAXION

Very efficient drop-resistant progress-capture pulley

The PRO TRAXION progress-capture pulley is designed to allow rope installation while the pulley is connected to the anchor. With its large-diameter sheave and great efficiency, it is particularly suitable for hauling heavy loads. The side plate locks when loaded and prevents opening of the pulley during use. The lower connection point can be used to create different types of haul systems.



MICRO TRAXION

High-efficiency, ultra-compact progress-capture pulley

MICRO TRAXION is an ultra-compact, extremely light progress-capture pulley that is exceptionally efficient. The cam can be locked in the open position so the device can be used as a simple pulley.

Prusik pulleys



MINI

Highly efficient and lightweight Prusik pulley

The MINI compact pulley offers a lightweight solution for setting up progress-capture haul systems.



GEMINI

Highly efficient and lightweight double Prusik pulley

GEMINI is a compact double pulley for setting up progress-capture haul systems of high mechanical advantage.



MINDER

High strength, very high efficiency Prusik pulley

MINDER is a high-strength pulley designed for rescue professionals, for setting up progress-capture haul systems.



TWIN

High-strength, very high efficiency double Prusik pulley

TWIN is a high-strength double pulley designed for rescue professionals. It can be used to set up progress-capture haul systems of high mechanical advantage.



Pulleys

Single pulleys



MOBILE

Versatile ultra-compact pulley

Compact and extremely lightweight, the MOBILE pulley is designed for a variety of uses.



FIXE

Versatile compact pulley

Versatile and compact, the FIXE pulley allows quick installation onto the rope.

Transport pulleys



TANDEM® / TANDEM® SPEED

Double pulleys for Tyroleanes

TANDEM and TANDEM SPEED are designed for Tyroleanes on cables or ropes, and can accept up to three connectors to facilitate maneuvers. TANDEM is used on a rope. TANDEM SPEED can also be used on a cable because of its wear-resistant sheaves mounted on sealed ball bearings.



KOOTENAY

Knot-passing pulley

KOOTENAY is a knot-passing pulley that allows passage of joining knots.

The large-diameter sheave mounted on sealed ball bearings ensures excellent efficiency.

ROLLCAB

Roller for movement along cable

ROLLCAB is a roller designed for movement and evacuation along mechanical lift cables.

Haul kit



JAG SYSTEM

Haul kit

The JAG SYSTEM haul kit is designed for pickoffs, for making a releasable anchor, or for tensioning a system, thanks to its 4:1 mechanical advantage and excellent efficiency (sheaves with sealed ball bearings). The collapsed kit is highly compact, allowing it to be used even when the distance to the anchor is very short. The JAG SYSTEM haul kit is quick and easy to deploy: it is ready to use thanks to the flexible cover that prevents any risk of tangling. The haul end is color-coded for instant identification. It is available in three lengths: 1, 2 and 5 meters.



JAG TRAXION

High-efficiency double progress-capture pulley

The JAG TRAXION double progress-capture pulley is designed for use with the JAG pulley to make a 4:1 haul system. Sheaves with sealed ball bearings ensure excellent efficiency.



JAG

High-efficiency double pulley

The JAG double pulley is designed for use with the JAG TRAXION double progress-capture pulley to make a 4:1 haul system. Sheaves with sealed ball bearings ensure excellent efficiency.

ANCHORS

Anchors are the link between the safety system and the structure or terrain. To complement the standard anchor equipment, Petzl offers a lifeline device specific to horizontal progression and a complete set of accessories.

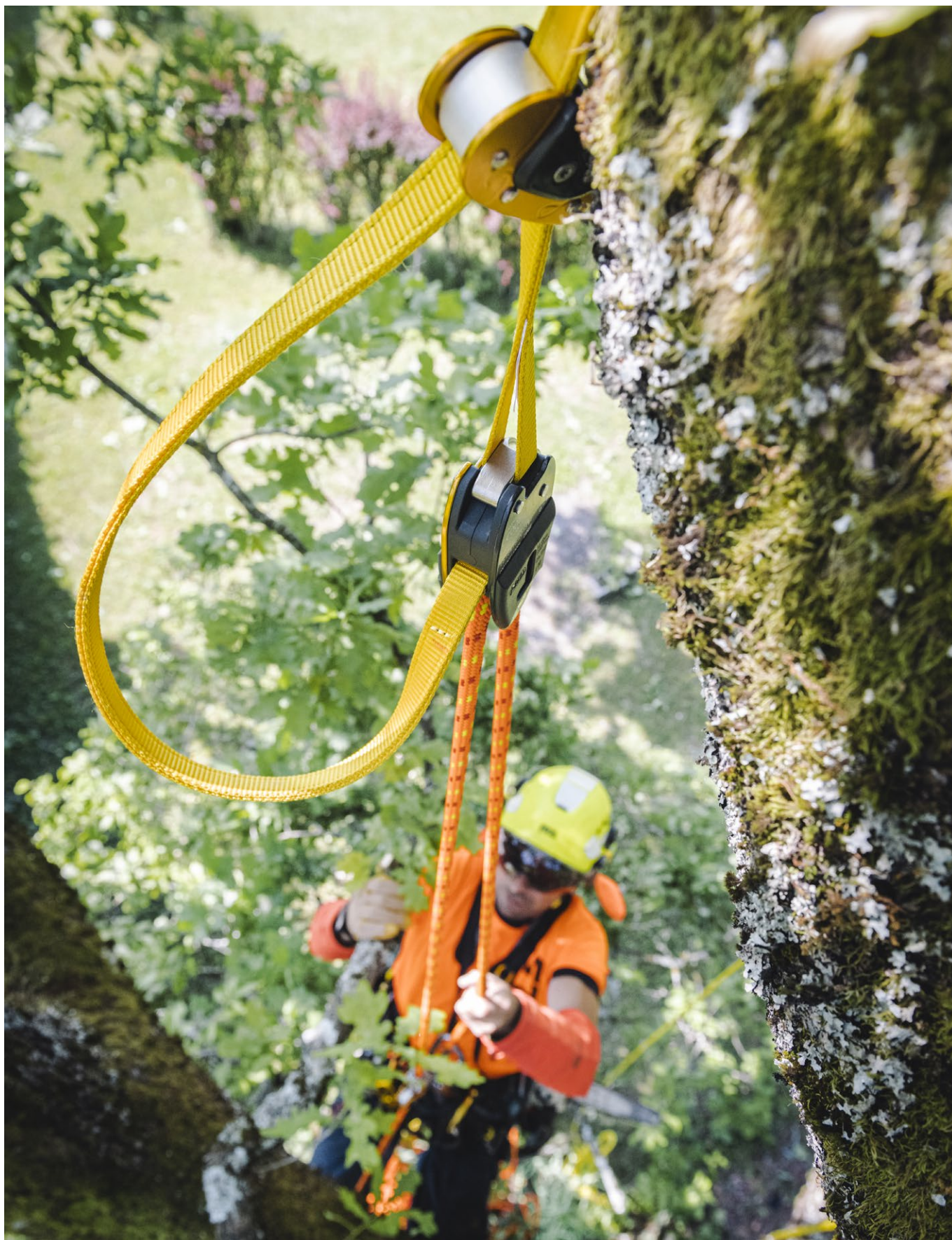

Rock and concrete anchors

Elements that allow installation of temporary or permanent fixed anchors.

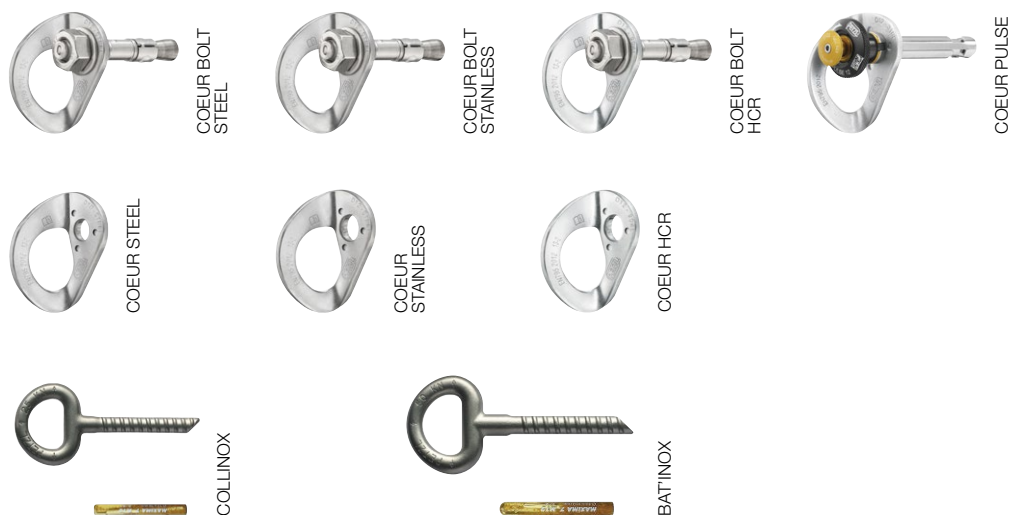

Rigging equipment

Swivels provide a solution to the problems of twisting and tangling ropes, especially when hauling. Rigging plates allow the workstation to be organized and increase the number of anchoring options. Rings allow multiple anchors to be organized.



Anchor straps

Slings designed for installation of easily transportable temporary anchors, offering adjustability, or a choice of lengths.

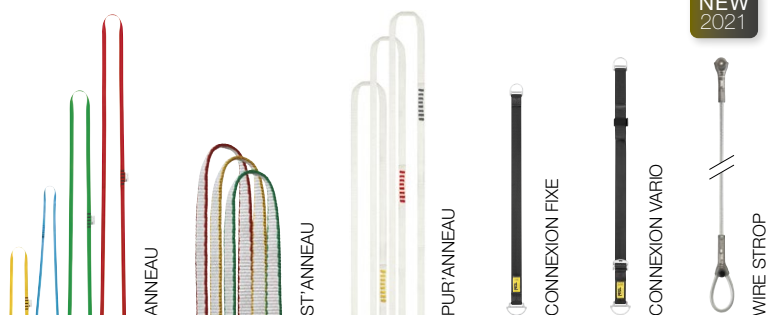

Quick adjustment anchors

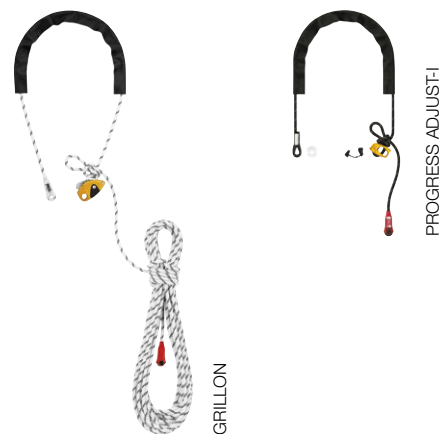

Temporary horizontal lifeline

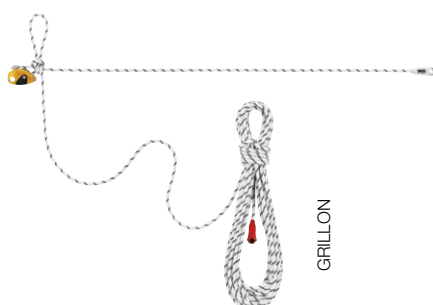

Anchor straps for tree care

Friction savers for tree care.

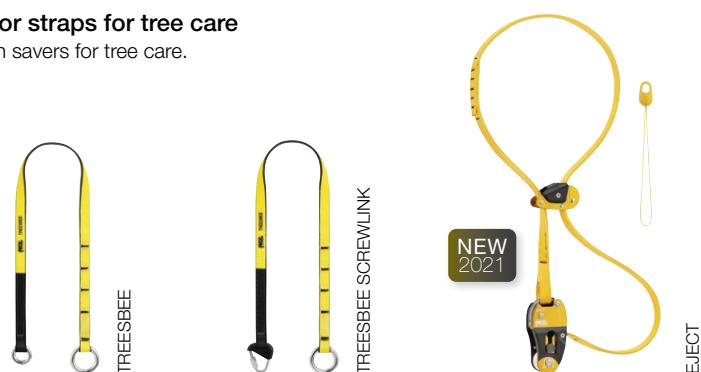



COEUR BOLT STEEL / STAINLESS / HCR

Anchors comprised of a COEUR hanger, a nut and a bolt (pack of 20)

Different steels suited to various environments

Petzl anchors (hangers and bolts) use different types of steels to adapt the anchor to the environment in which it is used:

- Standard steel, designed for interior uses or non-permanent installations: **COEUR BOLT STEEL**
- 316L high quality stainless steel, designed for typical exterior uses: **COEUR BOLT STAINLESS**
- HCR 904 (High Corrosion Resistance) stainless steel, designed for ultra-corrosive environments: **COEUR BOLT HCR**

Hangers (COEUR STEEL, COEUR STAINLESS and COEUR HCR) and bolts (BOLT STEEL, BOLT STAINLESS and BOLT HCR) are also available separately (pack of 20).



COEUR PULSE

Removable 12 mm anchor with locking function

The COEUR PULSE is a 12 mm removable stainless steel anchor that can be installed and removed very simply and rapidly, without tools. The locking function limits the risk of accidental removal.

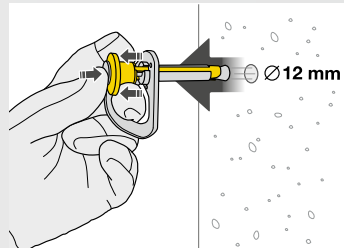

Simple, rapid installation and removal, without tools.

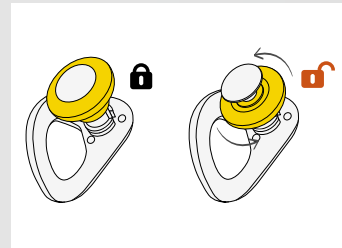

Manual screw-lock function limits the risk of involuntary removal.



COLLINOX

Forged stainless steel glue-in bolt (pack of 10)



AMPOULE COLLINOX

Resin glue for COLLINOX (pack of 10)



BAT'INOX

Forged stainless steel glue-in bolt (pack of 10)



AMPOULE BAT'INOX

Resin glue for BAT'INOX (pack of 10)



MICRO SWIVEL

Compact gated swivel

The compact, gated MICRO SWIVEL is designed for attachment to a locking carabiner. It helps prevent twisting of lanyards and allows correct positioning of devices. Its design without bearings allows it to turn freely when not loaded and to stop moving when loaded in order to hold the devices in position.



SWIVEL OPEN

Gated swivel with sealed ball bearings

The SWIVEL OPEN gated swivel features a large opening and thus can be attached to a wide range of products (pulleys, lanyards...). It reduces the bulk and weight of component systems and solves the twisting and tangling problems of ropes and lanyards. Sealed ball bearings offer excellent performance and reliability.



SWIVEL

Ball bearing swivel

Available in two sizes, the SWIVEL prevents the rope from twisting when the load is turning. Sealed ball bearings offer excellent performance and reliability.



PAW

Rigging plate

Available in three sizes, the PAW rigging plate can be used to organize a workstation and to set up multi-anchor systems. The hole design allows ropes or slings to be threaded for direct connection. Made of forged aluminum, it offers an excellent strength-to-weight ratio.



RING

Connection ring

The RING connection ring can be used to create multiple anchors or be installed directly onto the SEQUOIA and SEQUOIA SRT harnesses' attachment bridges to improve the arborist's lateral mobility.



RING OPEN

Multidirectional gated ring

See page 104 for details on the RING OPEN multidirectional gated ring.



Anchor slings and straps



ANNEAU

Open loop sling

ANNEAU is an open loop sling available in four lengths, color-coded for easy identification of length.

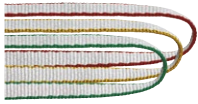

ST'ANNEAU

Sling in high-modulus polyethylene

ST'ANNEAU is a lightweight alternative to classic slings, available in three lengths, with color coding for easy identification of length.



PUR'ANNEAU

Very lightweight sling in high-modulus polyethylene

PUR'ANNEAU is a very lightweight sling with exceptional durability, thanks to its high-modulus polyethylene construction. It is particularly supple, for easy handling. Available in three lengths, color-coded for easy identification of length.



CONNEXION FIXE

Anchor strap

CONNEXION FIXE is a durable anchor strap with two forged steel attachment points. It offers several configurations for setting up an anchor: directly to an anchor point or around a suitable structure. It is available in three lengths (100, 150 and 200 cm).



CONNEXION VARIO

Adjustable anchor strap

CONNEXION VARIO is a durable and adjustable anchor strap equipped with two forged steel attachment points. It offers several configurations for setting up an anchor: directly to an anchor point or around a suitable structure. The strap length is adjustable, thanks to an adjustment buckle. A system keeps the remaining webbing stowed. It is available in two versions (30 to 200 cm and 200 to 400 cm).



WIRE STROP

Anchor strap

WIRE STROP is an anchor strap made of 6.5 mm diameter galvanized steel with two terminations of different sizes. It offers several configurations for setting up an anchor: directly to an anchor point or around a suitable structure. The plastic sheath helps hold the connector in position and facilitates clipping. It is available in five lengths (50, 100, 150, 200 and 300 cm).



Anchor strap with two terminations of different sizes. The plastic sheath helps hold the connector in position and facilitates clipping.

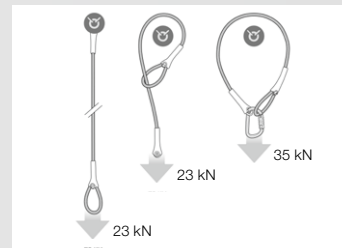

It offers several configurations for setting up an anchor: directly to an anchor point or around a suitable structure.

Quick adjustment anchors



GRILLON anchor Quick-adjustment anchor

The adjustable GRILLON anchor can be used to quickly set a fixed anchor point. The length of rope required to set it is easily adjusted with the integrated self-locking device. The removable protective sheath allows smoother rope glide while protecting the rope from abrasive surfaces. It is available in four lengths.



PROGRESS ADJUST-I anchor Lightweight quick-adjust anchor

Lightweight and compact, the PROGRESS ADJUST-I adjustable anchor can be used to quickly set up a fixed anchor point. The rope length required to set it up is easily adjusted with the ADJUST rope adjuster. The removable protective sheath protects the rope, while enhancing rope glide. It is available in three lengths (2, 3 and 5 m).

Temporary horizontal lifeline

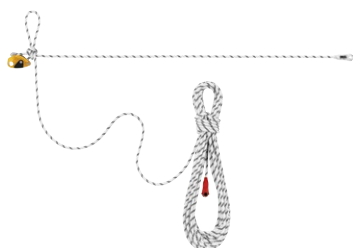

GRILLON lifeline Temporary horizontal lifeline

GRILLON allows a horizontal lifeline to be installed quickly when there is a large work area to cover. The integrated self-locking device allows easy adjustment of length, depending on the distance between two anchor points. It is available in four lengths to adapt to any situation.



Anchor straps for tree care



TREESBEE

Friction saver for tree care, designed for ropes with spliced terminations

The TREESBEE anchor strap is used to improve rope glide at the anchor while protecting the tree from abrasion. It is designed for ropes with spliced terminations (the splice goes through the small ring).



TREESBEE SCREWLINK

Friction saver for tree care, designed for ropes with sewn terminations

The TREESBEE SCREWLINK anchor strap is used to improve rope glide at the anchor while protecting the tree from abrasion. It is designed for ropes with sewn terminations (the link opens to let the sewn termination through).



EJECT

Adjustable friction saver for tree care, with pulley, that is easily retrievable from the ground

Designed for tree care, the EJECT friction saver allows the work rope to be set up, without damaging the tree, even in narrow forks. It offers multiple setup configurations on one or two branches and has an adjuster that allows precise length adjustment of the friction saver. Rope ascents and movement in the tree are optimized, thanks to the high-efficiency pulley which facilitates rope glide at the anchor. The included retrieval ball makes the system easily retrievable from the ground.

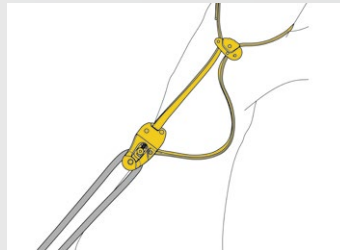

The system enables multiple setup configurations on the branch: wrap-around or choked. It has an adjuster that allows precise length adjustment of the friction saver.



Rope installation is possible only if the friction saver is correctly set up, and the gated attachment point is locked.



Strap for EJECT

Strap for EJECT adjustable friction saver

This strap is specially designed for the EJECT adjustable friction saver. It can be used to replace the original strap, or for linking two straps to lengthen the friction saver and enable work on larger-diameter trees. It is available in two lengths: 150 and 250 cm.

Retrieval ball for EJECT

Retrieval ball for EJECT adjustable friction saver

With a diameter of 21 mm, this retrieval ball is specially designed for the EJECT adjustable friction saver. It enables quick and easy system retrieval from the ground.

		Certifications	Diameter	Shear strength in 50 MPa concrete	Pull-out strength in 50 MPa concrete	Weight
Rock and concrete anchors						
COEUR BOLT STEEL	P36BA 10	-	10 mm	23 kN	15 kN	110 g
	P36BA 12	EN 959	12 mm	25 kN	18 kN	135 g
COEUR BOLT STAINLESS	P36BS 10	EN 959	10 mm	25 kN	15 kN	110 g
	P36BS 12		12 mm		18 kN	135 g
COEUR BOLT HCR	P36BH 12	EN 959	12 mm	25 kN	18 kN	145 g
COEUR STEEL	P36AA 10	EN 795 A	10 mm	-	-	65 g
	P36AA 12	EN 795 A - EN 959	12 mm			60 g
COEUR STAINLESS	P36AS 10	EN 795 A - EN 959	10 mm	-	-	65 g
	P36AS 12		12 mm			60 g
COEUR HCR	P36AH 12	EN 795 A - EN 959	12 mm	-	-	60 g
COEUR PULSE	P37S 12	CE EN 795 B	12 mm	25 kN	20 kN	140 g
COLLINOX	G100AA00	EN 959	10 mm	25 kN	15 kN	95 g
AMPOULE COLLINOX	G101AA00	-	-	-	-	14 g
BAT'INOX	G102AA00	EN 959	14 mm	25 kN	15 kN	250 g
AMPOULE BAT'INOX	G103AA00	-	-	-	-	20 g

		Certifications	Breaking strength	Weight
--	--	----------------	-------------------	--------

Rigging equipment					
MICRO SWIVEL	P58 XSO	CE - EAC		23 kN	75 g
SWIVEL OPEN	P58 SO	CE - EAC - NFPA 1983 Technical Use		23 kN	130 g
SWIVEL	S P58 S	CE - EAC - NFPA 1983 Technical Use		23 kN	95 g
	L P58 L	CE - EAC - NFPA 1983 General Use		36 kN	150 g
NEW 2021 PAW	S G063AA00 / G063AA00 (1)	CE NFPA 1983 General Use		36 kN	60 g
	M G063BA00 / G063BA01 (1)			45 kN	180 g
RING	L G063CA00 / G063CA01 (1)			50 kN	350 g
	S C04620			23 kN	40 g
	L C04630				70 g

		Certifications	Length	Breaking strength	Weight
--	--	----------------	--------	-------------------	--------

Anchor slings and straps					
ANNEAU	C40A 60, C40 60N (1)	CE EN 566 CE EN 795 B EAC	60 cm	22 kN	60 g
	C40A 80, C40 80N (1)		80 cm		80 g
	C40A 120, C40120 N (1)		120 cm		100 g
	C40A 150		150 cm		135 g
ST'ANNEAU	C07 24	CE EN 795 B	24 cm	22 kN	10 g
	C07 60		60 cm		20 g
	C07 120		120 cm		40 g
PUR'ANNEAU	G006AA00	CE EN 795 B	60 cm	22 kN	18 g
	G006AA01		120 cm		32 g
	G006AA02		180 cm		48 g
CONNEXION FIXE	G010AA00	CE EN 795 B NFPA 1983 General Use ANSI Z359.18 CSA Z259.15-17	100 cm	25 kN	355 g
	G010AA01		150 cm		415 g
	G010AA02		200 cm		475 g
CONNEXION VARIO	G011AA00		30 - 200 cm	25 kN	810 g
	G011AA01		200 - 400 cm		950 g
NEW 2021 WIRE STROP	G200AA00	CE EN 795 B CE EN 354 TS 16415 (2) NFPA 1983 Technical Use ANSI Z359.18	50 cm	23 kN	220 g
	G200AA01		100 cm		320 g
	G200AA02		150 cm		420 g
	G200AA03		200 cm		520 g
	G200AA04		300 cm		720 g

Quick-adjust anchors and temporary horizontal lifeline					
---	--	--	--	--	--

GRILLON anchor	L052AA00, L052AA07 (1)	CE EN 795 B & C EAC	2 m	-	480 g
	L052AA01, L052AA08 (1)		3 m	-	560 g
	L052AA02		4 m	-	640 g
	L052AA03		5 m	-	720 g
GRILLON lifeline	L052AA04		10 m	-	1075 g
	L052AA05		15 m	-	1475 g
	L052AA06		20 m	-	1875 g
	L044BA01		2 m	-	300 g
PROGRESS ADJUST-I anchor	L044BA02	CE EN 795 EAC	3 m	-	370 g
	L044BA03		5 m	-	510 g

Anchor straps for tree care					
------------------------------------	--	--	--	--	--

TREESBEE	C04110	CE EN 795 B	110 cm	23 kN	240 g
TREESBEE SCREWLINK	C04110 M	CE EN 795 B	110 cm	18 kN	295 g
NEW 2021 EJECT	G001AA00	CE EN 795 B - CE EN 12278 EAC - TS 16415	150 cm	25 kN	490 g
Strap for EJECT	G002AA00	-	150 cm	-	140 g
	G002AA01	-	250 cm	-	225 g
Retrieval ball for EJECT	G003AA00	-	-	-	8 g



ROPES

The line of Petzl ropes is designed for professionals in the vertical world. They offer effective solutions for the requirements of various activities: rope access, technical rescue, industry.



Technical rescue training with GRIMP 30, Nîmes, France © 2020 - Petzl Distribution - Vuedici.org - GRIMP 30 - VATEL

Low-stretch kernmantle ropes

For work at height

Standard diameter low-stretch kernmantle rope ensures a good grip for easier handling.



AXIS 11 mm

For rope access

Low-stretch kernmantle rope with small diameter ensures very good performance in terms of flexibility and weight.



PAPALLEL 10.5 mm

For rescue

Low-stretch kernmantle rope with a large diameter ensures great strength and excellent handling when working with heavy loads.



VECTOR 12.5 mm

For tree care

Low-stretch kernmantle rope with splice provides optimal performance when used with the ZIGZAG and ZIGZAG PLUS mechanical Prusiks.



FLOW 11.6 mm



CONTROL 12.5 mm

Static ropes

For long descents when intermediate anchors are not possible.

NEW
2021



RAY 11 mm

Dynamic rope

For progression using rock climbing techniques.

NEW
2021



MAMBO 10.1 mm

Technical cord

Cord for setting up Prusik hitches, anchors or haul systems.



SEGMENT 8 mm

Accessory cord

Cord for guiding a victim during rescue, or for hauling equipment.



Cords
4, 5, 6, 7 mm

Rope accessory

Professional rope accessory.



NEW
2021

Rope end
identification kit

Rope protectors

Devices that protect the rope at rub points.



PROTEC



SET CATERPILLAR



ROLL MODULE



Low-stretch kernmantle ropes

A specific construction for each use and a choice of lengths and colors according to user needs.



• EverFlex technology: guaranteed flexibility and handling over time

This technology ensures great flexibility over time and under any conditions (water, dust, mud...). The flexibility allows it to maintain consistent handling over the long run and perform optimally with devices.

• Multiple certifications

Petzl low-stretch kernmantle ropes are certified to the following standards:

- European: CE EN 1891 type A
- American: NFPA 1983 (except FLOW 11.6 mm and CONTROL 12.5 mm, which allow working in compliance with the ANSI Z133 standard)
- Russian: EAC

• Available in several lengths and colors

Petzl low-stretch kernmantle ropes come in several standard lengths, according to user needs and activities.



For work at height, rope access work and rescue

They are also available in six colors for easy differentiation of kits, work ropes, safety ropes, and collective access ropes.



For tree care

They are available in two colors, to differentiate working ropes from access ropes.

• Petzl Custom service for ropes



Petzl Custom service allows you to choose:

- rope color
- rope length
- type of termination (sewn or not, only on low-stretch kernmantle ropes)

AXIS 11 mm CUSTOM: R074DA
 PARALLEL 10.5 mm CUSTOM: R077DA
 VECTOR 12.5 mm CUSTOM: R078DA
 SEGMENT 8 mm CUSTOM: R076DA
 RAY 11 mm CUSTOM: R100XY

• For work at height

Standard diameter low-stretch kernmantle ropes ensure a good grip and compatibility with most devices.

• For rope access

Low-stretch kernmantle rope with small diameter ensures very good performance in terms of flexibility and weight.

• For rescue

Low-stretch kernmantle rope with a large diameter ensures great strength and excellent handling when working with heavy loads.

• For tree care

Low-stretch kernmantle ropes with splice provide optimal performance when used with the ZIGZAG and ZIGZAG PLUS mechanical Prusiks.

∅ 11,6 mm

∅ 12,5 mm



AXIS 11 mm

Low-stretch kernmantle rope with good handling for work at height

The AXIS 11 mm low-stretch kernmantle rope is designed for work at height. The standard diameter ensures a good grip for easier handling. EverFlex technology guarantees great flexibility and consistent performance over time. Rope available in six colors and four lengths.



PARALLEL 10.5 mm

Low-stretch kernmantle rope, flexible and lightweight for rope access

The PARALLEL 10.5 mm low-stretch kernmantle rope is designed for rope access. The small diameter ensures very good performance in terms of flexibility and weight. It has low elongation when under tension, increasing efficiency at the start of a rope ascent. EverFlex technology guarantees great flexibility and consistent performance over time. Rope available in six colors and four lengths.



VECTOR 12.5 mm

Low-stretch kernmantle, high-strength rope with excellent handling, for rescue

The VECTOR 12.5 mm low-stretch kernmantle rope is designed for rescue. The very large diameter ensures great strength and excellent grip when handling heavy loads. EverFlex construction guarantees great flexibility and consistent performance over time. Rope available in six colors and four lengths.



FLOW 11.6 mm

Flexible and lightweight low-stretch kernmantle rope, for tree care

The FLOW 11.6 mm low-stretch kernmantle rope is designed for tree care. The small diameter ensures very good performance in terms of flexibility and weight. It has low stretch when loaded, increasing efficiency when moving through the tree. EverFlex technology guarantees great flexibility and handling over time. It comes with a splice at one end for optimal rope glide through devices like a friction saver or pulley, and through tree branches. The small size of the splice allows it to pass through the friction chain of the ZIGZAG and ZIGZAG PLUS mechanical Prusiks. Rope available in two colors and three lengths.



CONTROL 12.5 mm

Low-stretch kernmantle, high-strength rope with excellent handling, for tree care

The CONTROL 12.5 mm low-stretch kernmantle rope is designed for tree care. The large diameter ensures high strength and excellent grip. EverFlex technology guarantees great flexibility and handling over time. It comes with a splice at one end for optimal rope glide through devices like a friction saver or pulley, and through tree branches. The small size of the splice allows it to pass through the friction chain of the ZIGZAG and ZIGZAG PLUS mechanical Prusiks. Rope available in two colors and three lengths.



Ropes

Static ropes

NEW
2021



RAY 11 mm

Static kernmantle rope with good grip, for work at height and technical rescue

The RAY 11 mm static rope is designed for work at height and technical rescue involving long descents, when intermediate anchors are not possible. It has low elongation under load, for optimal precision during progression and positioning. The standard diameter ensures a good grip for easier handling. EverFlex technology guarantees great flexibility and consistent performance over time. Rope available in four colors and four lengths.

Dynamic rope

NEW
2021



MAMBO® 10.1 mm

Dynamic rope for progression using climbing techniques

The 10.1 mm diameter MAMBO dynamic rope is designed for work at height professionals who use climbing techniques for progression. The thick sheath improves abrasion resistance.

Technical cord



SEGMENT 8 mm

Technical cord

The SEGMENT 8 mm technical accessory cord is used when setting up Prusik hitches, anchors or haul systems. EverFlex construction guarantees great flexibility and consistent performance over time. Cord available in three lengths.

Accessory cord



Cords

Accessory cords

These rugged and durable cords are for guiding a victim during rescue, or for hauling equipment. Available in four diameters, in a 120 meter roll.

Rope accessory



NEW
2021







Rope end identification kit

The rope end identification kit can be used to replace old labels or to identify individual ropes for professional uses. It contains twenty pre-printed labels and twenty heat-shrink sheaths compatible with 10.5 to 13 mm ropes.

Reference	Weight
R002AA00	30 g

	Colors	Lengths	European certification	US certification	Russian certification	Weight per meter	
Low-stretch kernmantle ropes							
PARALLEL 10.5 mm 	R077AA03	white	50 m	CE EN 1891 type A	NFPA 1983 Technical Use	EAC	75 g
	R077AA04	yellow					
	R077AA05	black					
	R077AA35	blue					
	R077AA36	red					
	R077AA37	orange					
	R077AA09	white					
	R077AA10	yellow					
	R077AA11	black					
	R077AA12	blue					
	R077AA13	red					
	R077AA14	orange					
	R077AA21	white					
	R077AA22	yellow					
R077AA23	black						
R077AA24	blue						
R077AA25	red						
R077AA26	orange						
R077AA28	white	500 m					
VECTOR 12.5 mm 	R078AA03	white	50 m	CE EN 1891 type A	NFPA 1983 General Use	EAC	111 g
	R078AA04	yellow					
	R078AA05	black					
	R078AA38	blue					
	R078AA39	red					
	R078AA40	orange					
	R078AA09	white					
	R078AA10	yellow					
	R078AA11	black					
	R078AA12	blue					
	R078AA13	red					
	R078AA14	orange					
	R078AA21	white					
	R078AA22	yellow					
	R078AA23	black					
	R078AA24	blue					
	R078AA25	red					
	R078AA26	orange					
	R078AA28	white	500 m				
	R078AA00	white					
	R078AA01	yellow					
	R078AA02	black					
	R078AA35	blue					
	R078AA36	red					
	R078AA37	orange					
	R078AA06	white					
	R078AA07	yellow					
	R078AA08	black					
	R078AA41	blue					
	R078AA42	red					
R078AA43	orange						
R078AA15	white						
R078AA16	yellow						
R078AA17	black						
R078AA18	blue						
R078AA19	red						
R078AA20	orange						
R078AA27	white	1200 ft					

		Colors	Lengths	European certification	US certification	Russian certification	Weight per meter	
Low-stretch kernmantle ropes								
FLOW 11.6 mm 	R079AA00	green	35 m	CE EN 1891 type A	ANSI Z133	-	102 g	
	R079AA01	orange						
	R079AA02	green	45 m					
	R079AA03	orange						
	R079AA04	green	60 m					
R079AA05	orange							
CONTROL 12.5 mm 	R080AA00	green	35 m	CE EN 1891 type A	ANSI Z133	-	115 g	
	R080AA01	orange						
	R080AA02	green	45 m					
	R080AA03	orange						
	R080AA04	green	60 m					
R080AA05	orange							
Static ropes								
NEW 2021 RAY 11 mm 	R100AA00	white	150 ft	CE (1)	NFPA 1983 Technical Use CI 1801	EAC	98 g	
	R100AA01	black						
	R100AA02	yellow						
	R100AA03	blue						
	R100AA04	white	200 ft					
	R100AA05	black						
	R100AA06	yellow						
	R100AA07	blue						
	R100AA08	white	600 ft					
	R100AA09	black						
	R100AA10	yellow						
	R100AA11	blue						
R100AA12	white	1200 ft						
Dynamic rope								
NEW 2021 MAMBO 10.1 mm 	R32AC 050	turquoise	50 m	CE EN 892 UIAA	-	-	65 g	
	R32AD 050	green						
	R32AC 060	turquoise	60 m					
	R32AD 060	green						
	R32AC 070	turquoise	70 m					
	R32AD 070	green						
Technical cord								
SEGMENT 8 mm 	R076AA00	white	50 m	CE EN 564	NFPA 1983 Escape Use	-	43 g	
	R076AA03		100 m					
	R076AA06		200 m					
Accessory cord								
Cords	4 mm	R044AA00	orange	120 m	CE EN 564	-	-	10 g
	5 mm	R045AA00	red					15 g
	6 mm	R046AA00	green					24 g
	7 mm	R047AA00	blue					31 g
Rope protectors								
PROTEC	C45 N	-	-	-	-	-	95 g	
SET CATERPILLAR	P68	-	-	-	-	-	1055 g	
ROLL MODULE	P49	-	-	-	-	-	1330 g	

(1) CE certification based on the EN 12841 standard (more information in the Instructions for Use).



PACKS AND ACCESSORIES

For comfortable work, good tools are necessary: packs, gloves, accessories...

Petzl offers an entire line of innovative accessories, the result of numerous years of experience in the field.



Site facility and penstock inspection, France © 2020 Petzl Distribution - Rémi Flament - EDF - BATAKARST - ACROSYS

Transport bags

Robust and comfortable, these large-capacity bags are designed for organizing and transporting equipment to the worksite.

NEW
2021



DUFFEL 65

NEW
2021



DUFFEL 85

Packs

Comfortable and rugged, these packs are designed for organizing and carrying equipment in a vertical environment.



PERSONNEL 15L



PORTAGE 30L



TRANSPORT 45L

Upright packs

Placed on the ground, these packs keep their shape even when empty, for easy access to the inside of the pack.



BUCKET 25L



BUCKET 35L

Tree care accessories

Specific products that help with placing an access rope in a tree.



JET



AIRLINE



ECLIPSE

Gloves

Protective gloves.



CORDEX



CORDEX PLUS

Accessories

Knife and crampons to facilitate work and movement.



SPATHA



CRAB 6



SPIKY PLUS



Transport bags



NEW
2021

DUFFEL 65

Medium-capacity transport bag

Designed to be carried in multiple ways, DUFFEL 65 is a convenient, ergonomic bag with a volume of 65 liters. The back and shoulder straps are padded for comfort when used as a backpack. It is versatile and can be carried in multiple ways, thanks to its removable shoulder straps. It has a large opening which allows easy access to equipment, two pockets in the inner flap and a large side pocket for a helmet or shoes. A large transparent area allows rapid identification of the bag. It is constructed of high-strength TPU tarp fabric, for intensive use.



Large D-shaped opening for easy equipment organization



Padded, adjustable back and shoulder straps for comfortable carrying



NEW
2021

DUFFEL 85

Large-capacity transport bag

Designed to be carried in multiple ways, DUFFEL 85 is a convenient, ergonomic bag with a volume of 85 liters. The back and shoulder straps are padded for comfort when used as a backpack. It is versatile and can be carried in multiple ways, thanks to its removable shoulder straps. It has a large opening which allows easy access to equipment, two pockets in the inner flap and a large side pocket for a helmet or shoes. A large transparent area allows rapid identification of the bag. It is constructed of high-strength TPU tarp fabric, for intensive use.

Packs



PERSONNEL 15L

Durable small-capacity bag

The PERSONNEL is a durable and lightweight 15 liter backpack. It is made of PVC-free material, and its welded construction provides great strength. It is made for use under difficult conditions, and also has an ID card pocket.



PORTAGE 30L

Durable medium-capacity bag

The PORTAGE is a durable and comfortable 30 liter backpack. It is made of PVC-free material, and its welded construction provides great strength. With its padded shoulder straps, it is comfortable during long carries. It is made for use under difficult conditions, and also has an ID card pocket.



TRANSPORT 45L

Durable large-capacity pack

The TRANSPORT is an especially comfortable and durable 45 liter backpack. It is made of PVC-free material, and its welded construction provides great strength. It is ideal for long-distance carries with its padded back panel, waistbelt and shoulder straps. It is made for use under difficult conditions, and also has an ID card pocket.



Waistbelt, shoulder straps and back panel are padded for comfort.

Upright packs



BUCKET

Fabric pack, remains upright

Simple and durable, the BUCKET bag allows the user to store a rope and any associated equipment. It remains upright and keeps its shape, even when empty, for easy access to the inside of the bag. It is available in two colors and two versions: 25 and 35 liters.

Tree care accessories



JET

Throw-bag

Double-layer construction gives the JET throw-bag excellent longevity. Streamlined shape facilitates passage through tree branches. It is available in three versions: 250, 300 and 350 g.



AIRLINE

Throw-line

The AIRLINE throw-line offers an excellent compromise between flexibility and rigidity, for an accurate throw without the formation of knots as it comes out of the bag. The excellent sheath-core bond maintains a round cross-section, ensuring good rope glide through the tree. It is available in two lengths: 60 and 300 meters.



ECLIPSE

Storage for throw-line

ECLIPSE provides easy storage for AIRLINE throw-lines and JET throw-bags. The double bottom allows two throw-lines to be stored separately. Once folded into the small bag, it all fits perfectly into the BUCKET pack.

Gloves



CORDEX

Lightweight belay/rappel gloves

These lightweight belay/rappel gloves combine the durability of a work glove with the precise fit and dexterity of a thinner glove. Double-layered leather protects the palm and other high-wear areas. The back is made of abrasion-resistant, breathable stretch nylon, ensuring comfort and fit. The low profile neoprene cuff with Velcro closure features a reinforced carabiner hole for attaching the gloves to your harness.



CORDEX PLUS

Belay/rappel gloves

These medium weight belay/rappel gloves offer extra protection without sacrificing dexterity. Double-layer leather and padding protect the palm from heat generated during long rappels or lowers. Fingertips and other high-wear areas are reinforced for increased durability. The back is made of leather with abrasion-resistant stretch nylon at key flex areas. The low profile neoprene cuff with Velcro closure features a reinforced carabiner hole for attaching the gloves to your harness.

Accessories



SPATHA

Knife with carabiner hole

The SPATHA knife is designed to accompany the worker at height during all daily tasks. The profile of the blade allows easy cutting of ropes and cords. It has a carabiner hole for easily attaching the knife to the harness. It is easy to manipulate with its textured wheel, even when wearing gloves, and can be locked in the open position.



CRAB 6

6-point crampons

Six-point crampons, adaptable to all shoe sizes, used for moving over talus and snow- and ice-covered slopes.



SPIKY PLUS

Anti-slip soles

Anti-slip soles, adaptable to all shoe sizes, used for moving over snow and frozen or slippery surfaces.

		Capacity	Weight				
Transport bags							
		S045AA00	65 l / 1350 g				
		S045AA01	85 l / 1550 g				
Packs							
		S42Y 045	45 l / 1250 g				
		S43Y 030	30 l / 850 g				
		S44Y 015	15 l / 450 g				
Upright packs							
BUCKET		S41AY 025 (yellow)	15 l / 575 g				
		S41AR 025 (red)					
		S41AY 035 (yellow)	30 l / 680 g				
		S41AR 035 (red)					
Tree care accessories							
JET		S02Y 250	- / 250 g				
		S02Y 300	- / 300 g				
		S02Y 350	- / 350 g				
AIRLINE		R02Y 060	- / 2.1 g/m				
		R02Y 300	- / 2.1 g/m				
ECLIPSE		S03Y	- / 500 g				
		Size	Hand circumference	Color	Certifications		
Gloves							
CORDEX		K52 SN	S	8	20 cm	black	CE EN 420 CE EN 388 (3133) EAC
		K52 MN	M	8,5	21,5 cm		
		K52 LN	L	9	23 cm		
		K52 XLN	XL	9,5	24,5 cm		
		K52 XST	XS	7,5	19 cm	beige	
		K52 ST	S	8	20 cm		
CORDEX PLUS		K53 SN	S	8	20 cm	black	
		K53 MN	M	8,5	21,5 cm		
		K53 LN	L	9	23 cm		
		K53 XLN	XL	9,5	24,5 cm		
		K53 XST	XS	7,5	19 cm	beige	
		K53 ST	S	8	20 cm		
		K53 MT	M	8,5	21,5 cm		
		K53 LT	L	9	23 cm		
		K53 XLT	XL	9,5	24,5 cm		
					Size		
Accessories							
SPATHA		S92AN		-			
CRAB 6		64160		-			
SPIKY PLUS		79510		≤ 41			
		79520		42-45			
		79530		≥ 46			



KITS

Helping users to easily get equipped or to update their equipment, Petzl proposes kits for installing a temporary vertical life-line, for protecting falls, for work positioning or for evacuating a victim.



Tower rescue exercise on Frioul Island off Marseille, France © 2020 Petzl Distribution - Vuedici.org - Apesanteur.net - TDF

Temporary vertical lifelines and fall-arrest kits

Temporary vertical lifelines and ready-to-use kits designed for belaying and fall protection.

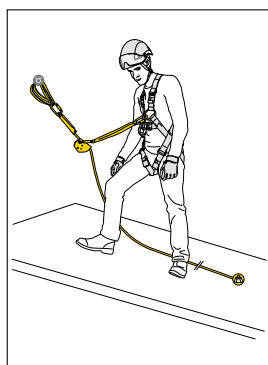

ASAP VERTICAL LIFELINE

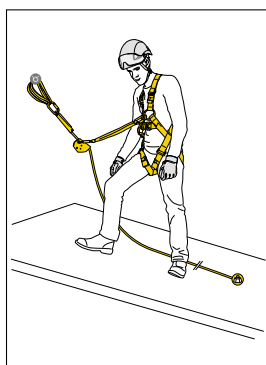

ASAP FALL-ARREST KIT

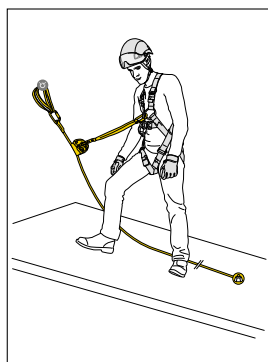

ASAP LOCK VERTICAL LIFELINE

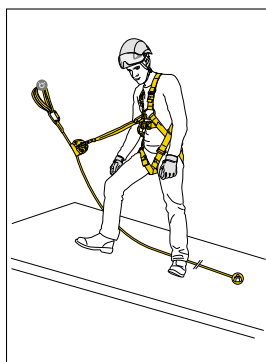

ASAP LOCK FALL-ARREST KIT



ABSORBICA-Y FALL-ARREST KIT

Fall-arrest and work positioning kits

Ready-to-use kit designed to protect against falls and for positioning at a workstation.

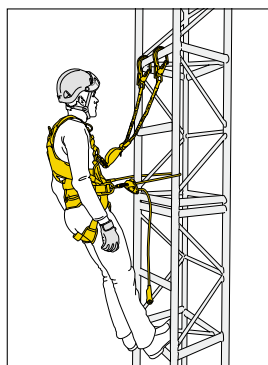

FALL-ARREST AND WORK POSITIONING KIT

Rescue kit

Ready-to-use kit, designed to pick off and lower a victim.

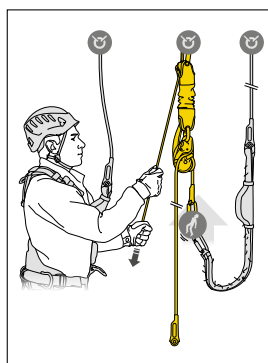

JAG RESCUE KIT



Temporary vertical lifelines and fall-arrest kits

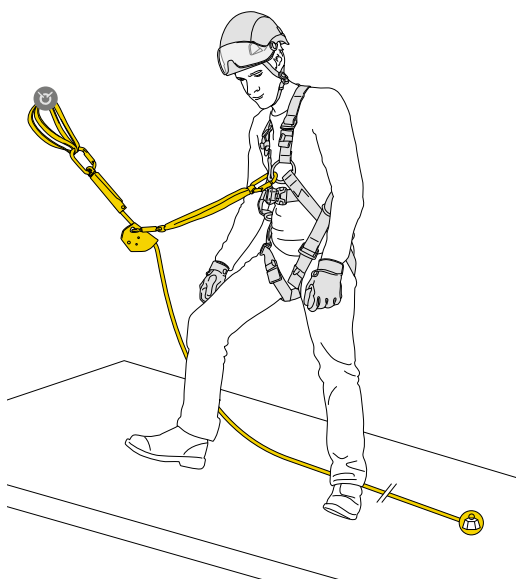

ASAP® VERTICAL LIFELINE

Vertical lifeline for protection against falls with ASAP mobile fall arrester

ASAP VERTICAL LIFELINE is a temporary vertical lifeline designed for belaying and to protect against falls from height. It contains an ASAP mobile fall arrester, an ASAP'SORBER energy absorber, three OK TRIACT-LOCK carabiners, an ANNEAU open sling, an AXIS 11 mm rope with sewn termination and integrated energy dissipater, a weight, and a BUCKET bag. It is available in two lengths.



ASAP
- page 95 -



ASAP'SORBER
- page 96 -



OK TRIACT-LOCK
- page 101 -



ANNEAU
- page 132 -



ASAP'AXIS 11 mm
- page 96 -



BUCKET
- page 147 -

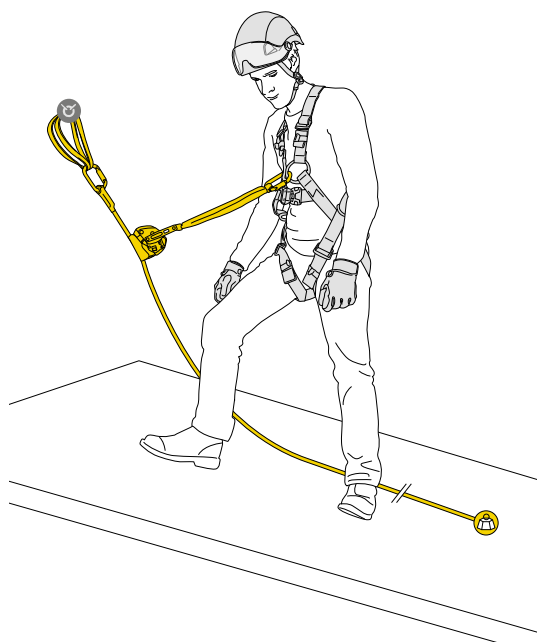

ASAP® LOCK VERTICAL LIFELINE

Vertical lifeline for protection against falls with ASAP LOCK mobile fall arrester

ASAP LOCK VERTICAL LIFELINE is a temporary vertical lifeline designed for belaying and to protect against falls from height. It contains an ASAP LOCK mobile fall arrester with locking function, an ASAP'SORBER energy absorber, two OK TRIACT-LOCK carabiners, an ANNEAU open sling, an AXIS 11 mm rope with sewn termination, a weight, and a BUCKET bag. It is available in two lengths.



ASAP LOCK
- page 95 -



ASAP'SORBER
- page 96 -



OK TRIACT-LOCK
- page 101 -



ANNEAU
- page 132 -



AXIS 11 mm
- page 139 -



BUCKET
- page 147 -

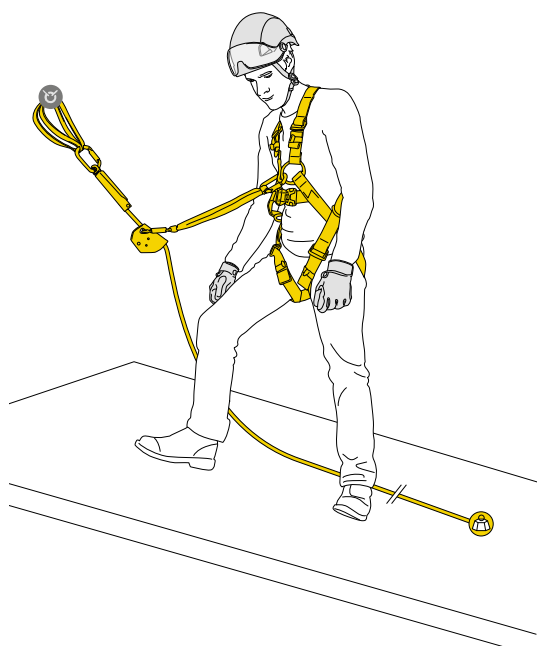

ASAP® FALL ARREST KIT

Kit for protection against falls, with NEWTON harness and ASAP mobile fall arrester

ASAP FALL ARREST KIT is a ready-to-use kit designed to protect against falls from height. It contains a NEWTON fall-arrest harness, an ASAP mobile fall arrester, an ASAP'SORBER energy absorber, three OK TRIACT-LOCK carabiners, an ANNEAU open sling, an ASAP'AXIS 11 mm rope with sewn termination and integrated energy dissipater, a weight, and a BUCKET bag. The kit is available in two sizes and four lengths.



NEWTON
- page 51 -



ASAP
- page 95 -



ASAP'SORBER
- page 96 -



OK TRIACT-LOCK
- page 101 -



ANNEAU
- page 132 -



ASAP'AXIS 11 mm
- page 96 -



BUCKET
- page 147 -

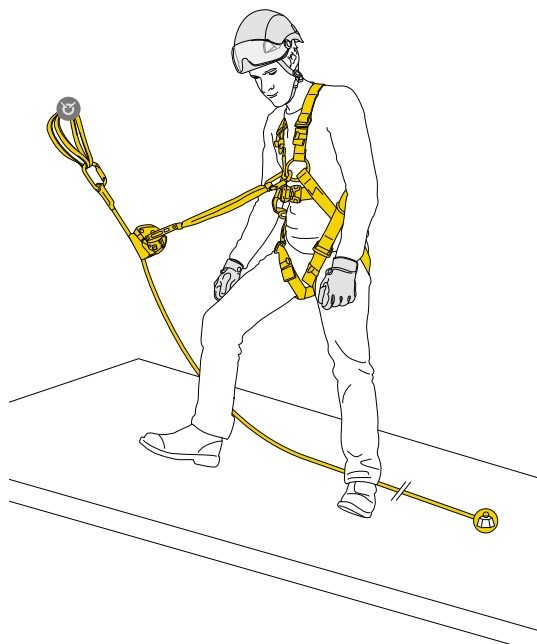

ASAP® LOCK FALL ARREST KIT

Kit for protection against falls, with NEWTON harness and ASAP LOCK mobile fall arrester

ASAP LOCK FALL ARREST KIT is a ready-to-use kit designed to protect against falls from height. It contains a NEWTON fall-arrest harness, an ASAP LOCK mobile fall arrester with locking function, an ASAP'SORBER energy absorber, two OK TRIACT-LOCK carabiners, an ANNEAU open sling, an AXIS 11 mm rope with sewn termination, a weight, and a BUCKET bag. The kit is available in two sizes and four lengths.



NEWTON
- page 51 -



ASAP LOCK
- page 95 -



ASAP'SORBER
- page 96 -



OK TRIACT-LOCK
- page 101 -



ANNEAU
- page 132 -



AXIS 11 mm
- page 139 -



BUCKET
- page 147 -



Temporary vertical lifelines and fall-arrest kits

NEW
2021

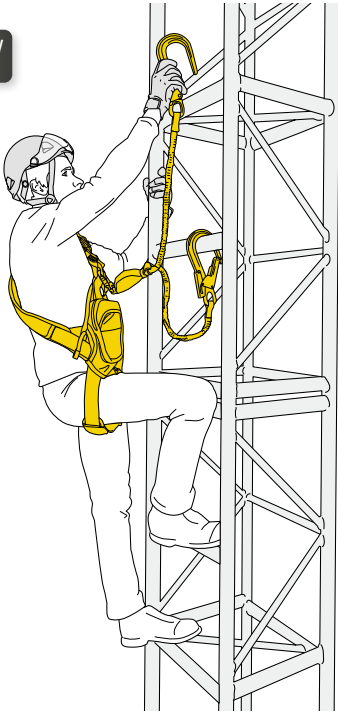

ABSORBICA-Y FALL ARREST KIT

Kit for protection against falls, with NEWTON EASYFIT harness and ABSORBICA-Y MGO 150 lanyard

ABSORBICA-Y FALL ARREST KIT is a ready-to-use kit designed for fall protection. It is optimized for work at height requiring connection to metal structures or large-diameter cables and bars. The kit contains a NEWTON EASYFIT fall-arrest harness, a 150 cm ABSORBICA-Y double lanyard with energy absorber and MGO large-opening connectors, an OK TRIACT-LOCK carabiner, a CAPTIV positioning bar, and a BUCKET bag. It is available in two sizes.



NEWTON EASYFIT
- page 53 -



ABSORBICA-Y
MGO 150
- page 87 -



OK TRIACT-LOCK
- page 101 -



CAPTIV
- page 104 -



BUCKET
- page 147 -

Fall-arrest and work positioning kit

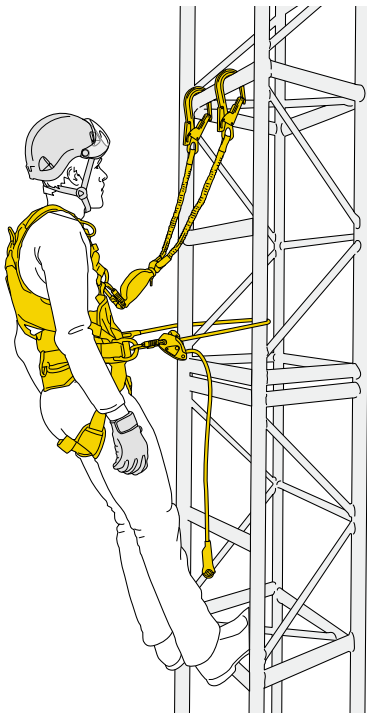

FALL ARREST AND WORK POSITIONING KIT

Fall-arrest and work positioning kit with VOLT harness, ABSORBICA-Y MGO 150 lanyard, and GRILLON HOOK

FALL ARREST AND WORK POSITIONING KIT is a ready-to-use kit designed to protect against falls and for positioning at a workstation. It is optimized for work at height requiring connection to metal structures or large-diameter cables and bars. The kit contains a VOLT fall-arrest and work positioning harness, a 150 cm ABSORBICA-Y double lanyard with energy absorber and MGO large-opening connectors, a 2-meter GRILLON HOOK adjustable work positioning lanyard, two OK TRIACT-LOCK carabiners, two CAPTIV positioning bars, and a BUCKET bag. It is available in two sizes.



VOLT
- page 55 -



ABSORBICA-Y
MGO 150
- page 87 -



GRILLON HOOK
- page 85 -



OK TRIACT-LOCK
- page 101 -



CAPTIV
- page 104 -



BUCKET
- page 147 -



Rescue kits

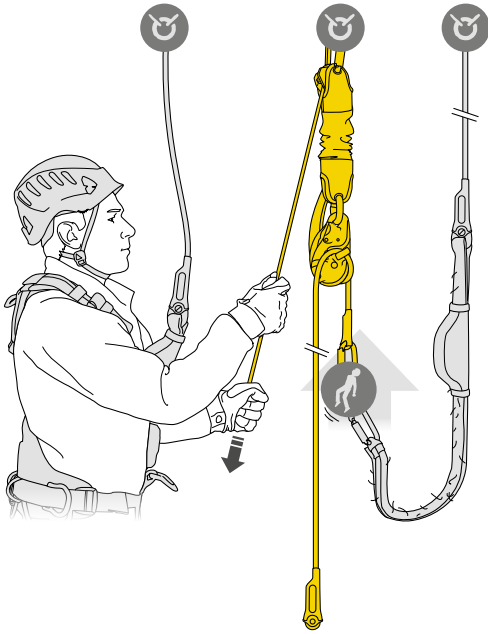

JAG RESCUE KIT

Reversible rescue kit with JAG SYSTEM haul kit and I'D EVAC descender

The JAG RESCUE KIT is a ready-to-use reversible rescue kit designed to easily pick off and lower a victim. It contains a JAG SYSTEM haul kit, a RING OPEN gated ring, an I'D EVAC descender with integrated brake, a CONNEXION FIXE 150 cm anchor strap, a BUCKET bag and an AXIS 11 mm rope with two sewn terminations. It is available in three lengths: 30, 60 and 120 m.



JAG SYSTEM
- page 126 -



RING OPEN
- page 104 -



I'D EVAC
- page 109 -



CONNEXION FIXE
- page 132 -



AXIS 11 mm
- page 139 -



BUCKET
- page 147 -

		Contents of kit	Harness size	Rope length	Weight
Temporary vertical lifelines and fall-arrest kits					
ASAP VERTICAL LIFELINE	K091AB00	ASAP ASAP'SORBBER 40 cm OK TRIACT-LOCK (x3) ANNEAU 150 cm	-	10 m	2325 g
	K091AB01	AXIS 11 mm rope with sewn termination and integrated energy dissipater 1 weight BUCKET 25 liters		20 m	3125 g
ASAP LOCK VERTICAL LIFELINE	K092AA00	ASAP LOCK ASAP'SORBBER 40 cm OK TRIACT-LOCK (x2) ANNEAU 150 cm	-	10 m	2455 g
	K092AA01	AXIS 11 mm with sewn termination 1 weight BUCKET 25 liters		20 m	3255 g
ASAP FALL ARREST KIT	K093AB00	NEWTON European version ASAP ASAP'SORBBER 40 cm OK TRIACT-LOCK (x3) ANNEAU 150 cm AXIS 11 mm rope with sewn termination and integrated energy dissipater 1 weight BUCKET 25 liters	1	10 m	3375 g
	K093AB01		2	10 m	3405 g
	K093AB02		1	20 m	4175 g
	K093AB03		2	20 m	4205 g
ASAP LOCK FALL ARREST KIT	K094AA00	NEWTON European version ASAP LOCK ASAP'SORBBER 40 cm OK TRIACT-LOCK (x2) ANNEAU 150 cm AXIS 11 mm with sewn termination 1 weight BUCKET 25 liters	1	10 m	3505 g
	K094AA01		2	10 m	3535 g
	K094AA02		1	20 m	4305 g
	K094AA03		2	20 m	4335 g
NEW 2021 ABSORBICA-Y FALL ARREST KIT	K095AC00	NEWTON EASYFIT international version ABSORBICA-Y European version 150 cm MGO OK TRIACT-LOCK (x1) CAPTIV (x1)	1	-	3460 g
	K095AC01	BUCKET 25 liters	2		3510 g
Fall-arrest and work positioning kit					
FALL ARREST AND WORK POSITIONING KIT	K096AB00	VOLT ABSORBICA-Y European version 150 cm MGO GRILLON HOOK European version 2 m	1	-	4810 g
	K096AB01	OK TRIACT-LOCK (x2) CAPTIV (x2) BUCKET 25 liters	2		4890 g
Rescue kit					
JAG RESCUE KIT	K090AA00	JAG SYSTEM RING OPEN I'D EVAC CONNEXION FIXE 150 cm AXIS 11 mm with sewn termination BUCKET 25 or 35 liters	-	30 m	4300 g
	K090AA01			60 m	6600 g
	K090AA02			120 m	11300 g



LIGHTING





A line for every use

The Petzl headlamp range covers the full spectrum of professional needs, from intensive to occasional use, and for different work environments that require varying degrees of brightness.

Professions	Industry, maintenance, inspection and rescue	Industry, energy and networks, construction, maintenance	Concerts and shows, artisans, small maintenance jobs
Frequency of use	Intensive	Frequent	Occasional to frequent
User needs	<ul style="list-style-type: none"> - Very powerful, intelligent lighting - Long burn time - Durable - Water resistance - Teamwork (except DUO RL) - ATEX certification (except DUO RL and DUO S) 	<ul style="list-style-type: none"> - ATEX or HAZLOC certification - Compact - Durable - Water resistance - Long burn time 	<ul style="list-style-type: none"> - Powerful lighting - Lightweight and compact - Very long burn time - Multiple lighting colors - Versatile - Resistant to water spray
Petzl solutions	<p>Performance headlamps</p>  <p>DUO RL</p>  <p>DUO S</p>  <p>DUO Z1</p>  <p>DUO Z2</p>	<p>Compact, durable headlamps</p>  <p>PIXA Z1</p>  <p>PIXA 3R</p>  <p>PIXA 3</p>  <p>PIXA 2</p>  <p>PIXA 1</p>	<p>Ultra-compact headlamps</p>  <p>SWIFT RL PRO</p>  <p>TACTIKKA CORE</p>  <p>TACTIKKA +RGB</p>  <p>TACTIKKA +</p>  <p>TACTIKKA</p>  <p>TACTIKKA ADAPT</p>  <p>e+LITE</p>

Intelligent lighting for greater convenience and performance

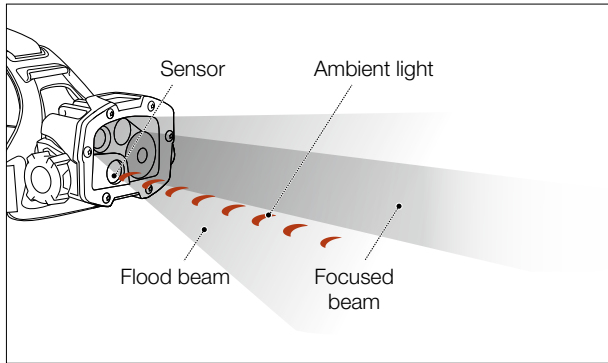

This exclusive technology, developed by Petzl, instantly provides the right lighting at the right time, without any need for manual operation. Burn time is thus optimized, and the user can remain focused on the activity.



REACTIVE LIGHTING® technology offers:

- intelligent lighting
- hands-free lighting for greater convenience and performance
- longer burn time

Available on the DUO RL and SWIFT RL PRO headlamps.

Come face-to-face without blinding each other, for better teamwork

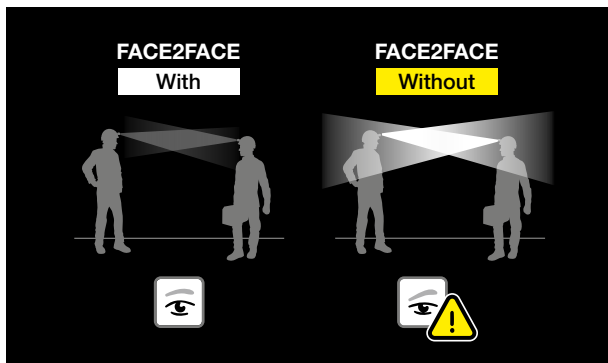

Once activated, the FACE2FACE function triggers a sensor that detects other DUO headlamps within 8 meters and automatically dims the lighting if they face each other. The light returns to its original intensity once the other headlamp is no longer in its line of sight.



Available on DUO S, DUO Z1 and DUO Z2 headlamps.

Choosing the energy source to fit the need

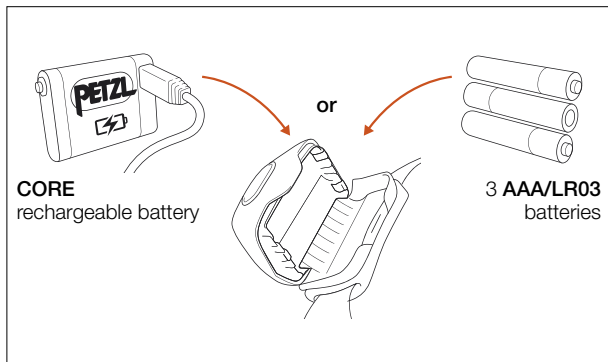

The HYBRID CONCEPT construction allows Petzl's compact headlamps to run on either the CORE rechargeable battery or three AAA/LR03 batteries, without an adapter.

- CORE rechargeable battery is an economical solution for frequent and/or intensive use
- AAA/LR03 batteries for occasional use, with very long burn time

Available on TACTIKKA CORE, TACTIKKA +RGB, TACTIKKA +, TACTIKKA and TACTIKKA ADAPT headlamps.

Compatible with all helmet types

All Petzl headlamps are designed to be worn on the head or a helmet, while allowing for tilting of the headlamp:

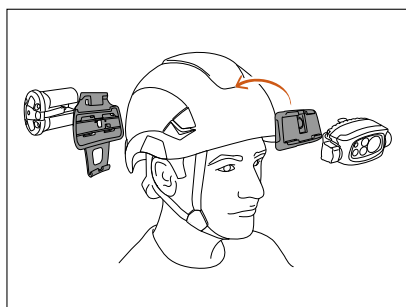

- on Petzl helmets, using their mounting plates

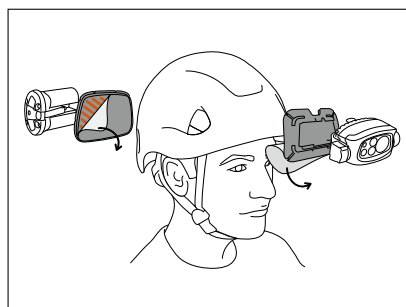

- on other helmets, using adhesive plates, available as accessories

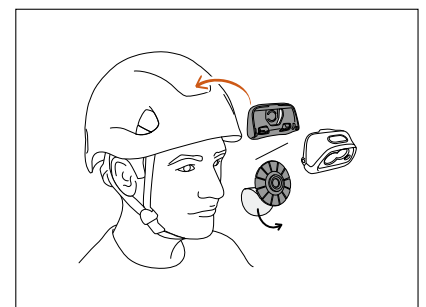

- TACTIKKA ADAPT, the ready-to-go solution that adapts to any type of helmet

Choosing a Petzl headlamp means selecting a work tool designed to withstand the most severe conditions of use, while ensuring maximum reliability.

Optical quality for optimal visual comfort

Petzl headlamps ensure maximum visual comfort for the user: lighting is uniform and has no bright point in the center, no spotting, no dark areas. Each batch of LEDs is tested and selected according to proper color homogeneity, low energy consumption, and high luminous flux. Each Petzl headlamp is individually inspected before leaving the factory. These operations include a test to measure lighting performance and beam homogeneity with the help of a digital camera.



Perfectly uniform beam:
user comfort



Presence of a
central bright spot:
blinding



Presence of
visual defects:
lack of precision,
discomfort, fatigue

Testing from design to manufacture

Each model must pass particularly stringent tests:

- for shock resistance, fall resistance and crushing (including at low temperatures)
- for functional reliability (mechanical endurance)
- individual inspection and test at the end of the assembly line (final quality check)
- for water resistance



Consideration of photobiological risk

Petzl has chosen to present information in its product instructions about the risks to the eyes associated with LED lighting. For this, the company uses the IEC 62778 and EN 62471: 2008 standards, Photobiological safety of lamps and devices using lamps. This standard classifies lamps according to risk groups.

The risk groups are as follows:

- Risk group 0: no risk
- Risk group 1: low risk The product presents no risk related to exposure limits under normal usage conditions
- Risk group 2: moderate risk The reflex to look away from the lamp suffices to reduce the risk



To learn more about photobiological safety and the information given in the Instructions for Use, see the technical information on LED lighting available at www.petzl.com



LED risk group 2 - IEC 62471

Do not stare at operating lamp.
May be harmful to the eyes.

Ne regardez pas fixement le faisceau de la lampe de face.
Peut être dangereux pour les yeux.

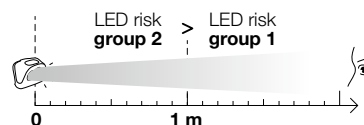

A question of balance

Brightness and burn time are two inextricably linked parameters of any headlamp, regardless of its lighting technology. For a given quantity of energy, increasing the brightness automatically decreases burn time, and vice versa.

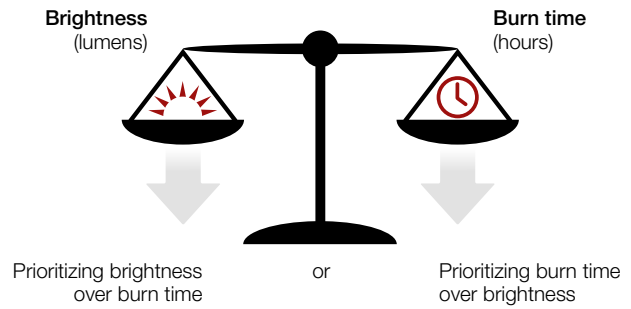

The different lighting technologies used in Petzl headlamps make it possible to meet your needs, depending on what you want:



Prioritizing burn time: STANDARD LIGHTING

Brightness decreases gradually as the batteries are drained. It is the most common technology.

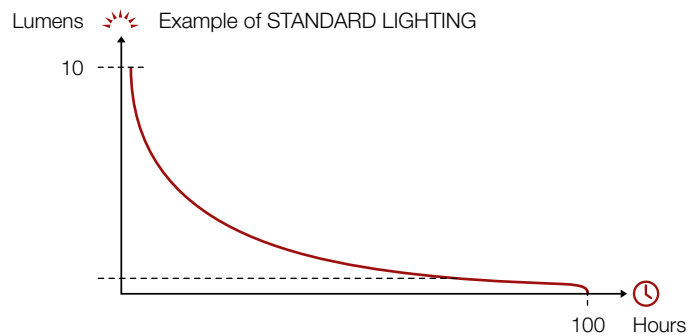

Prioritizing guaranteed brightness over time: CONSTANT LIGHTING

Brightness stays constant as the batteries drain. When the batteries are almost drained, the headlamp switches automatically to low-level reserve lighting, to extend burn time.

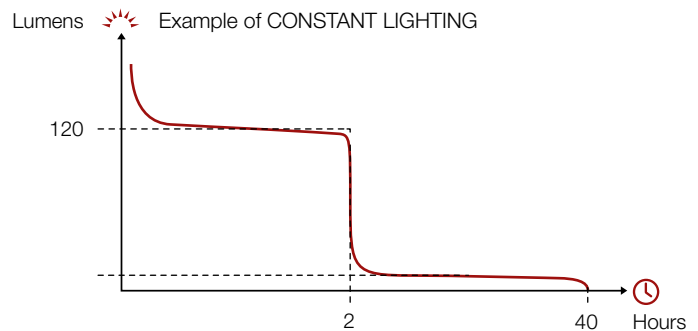

Optimized lighting performance: REACTIVE LIGHTING®

Brightness varies according to the user's need. Intelligent lighting thus optimizes battery life, offering greater burn time.

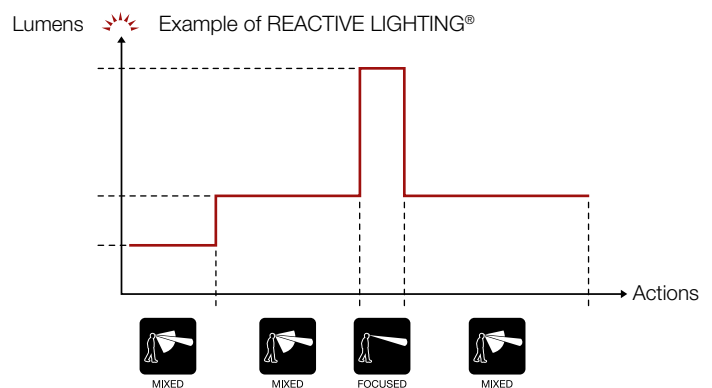

Brightness: the shape of the beam directly affects lighting distance

Lighting distance depends directly on brightness, but mainly on the shape of the beam. In fact, given the same brightness, lighting distance will vary depending on the shape of the beam.

Petzl indicates the different lighting modes available for each headlamp. These modes correspond to specific conditions of use: close-range work, moving around, seeing at a distance.



Environments and standards

Hazardous areas

If an explosion hazard is identified in an environment, the hazardous areas are classified as areas at risk, depending on the prevalence and type of combustible, gas or dust. All of the materials used in these zones must conform with current regulations for this type of zone (ATEX and/or HAZLOC).

Classification of ATEX / HAZLOC zones

Explosive atmosphere	Gas type combustible		Dust type combustible	
	ATEX	HAZLOC	ATEX	HAZLOC
Permanent or long-term	ZONE 0	Class I Div 1	ZONE 20	Class II Div 1
Occasional	ZONE 1	Class I Div 1	ZONE 21	Class II Div 1
Accidental	ZONE 2	Class I Div 2	ZONE 22	Class II Div 2

Example of ATEX zone (gas type combustible)

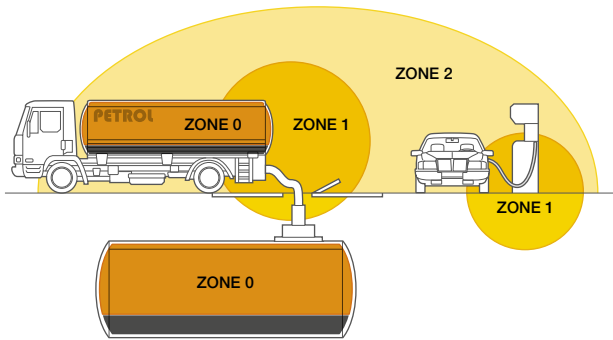

For more information on ATEX and HAZLOC regulations, see www.petzl.com

PETZL.COM

How to read an ATEX marking

Example:
DUO Z1

Ex	II 2 G	Ex ib	IIB	T4	Gb
Ex	II 2 D	Ex ib	IIIB	T135°	Db

II 2 G ATEX CODING					
Ex	II	2	GD		
EU Explosive atmosphere symbol	Equipment group		Equipment category		
	I: mining		M1: energised		
			M2: de-energised*		
	II: non-mining		1: very high protection	0	20
			2: high protection	1	21
			3: normal protection	2	22

* in presence of explosive atmosphere

IIB GAS GROUPS	
Gas group	Representative test gas
I	Methane (mining only)
IIA	Propane
IIB	Ethylene
IIC	Hydrogen

Gases are classified according to the ignitability of gas-air mixture. Refer to IEC/EN 60079-20-1 for classification of common gases and vapors.

T4 / T135° TEMPERATURE CLASS	
T class	Maximum surface temperature
T1	450°C
T2	300°C
T3	200°C
T4	135°C
T5	100°C
T6	85°C

Ex ib ELECTRICAL PROTECTION CONCEPTS				
Standard IEC/EN	Code		Zone	
60079-11	Ex ia	Intrinsic Safety	0	20
	Ex ib		1	21
	Ex ic		2	22

IIIB DUST GROUPS	
Dust group	Representative test dust
IIIA	Combustible flyings
IIIB	Non-conductive dust
IIIC	Conductive dust

Gb / Db EQUIPMENT PROTECTION LEVEL	
Equipment protection level	Zone
Ga	0
Gb	1
Gc	2
Da	20
Db	21
Dc	22
Ma	energised*
Mb	de-energised*

G = Gas, D = Dust, M = Mining
* in presence of explosive atmosphere

Lighting performance as defined by the ANSI/PLATO FL 1 protocol

Petzl has chosen to comply with the ANSI (American National Standards Institute) FL 1 protocol to measure and demonstrate the lighting performance and burn times of our headlamps. This voluntary move allows users to easily compare the lighting performance and burn times of different headlamp models using standardized criteria.

Lighting performance: How is it measured?



MAX
BRIGHTNESS

Brightness (lumens)

This measurement is taken between 30 and 120 seconds after the headlamp is turned on. It indicates the maximum light output, when the lamp is first turned on, using new batteries (included).



MAX
BURN TIME

Burn time (hours)

This is the length of time for which lighting remains optimal, from the moment the lamp is turned on until it drops to 10 % of maximum light output. It then switches to reserve lighting.



MAX
DISTANCE

Lighting distance (meters)

This is the maximum distance between the lamp and the location where only 0.25 lux of illumination remains. The measurement is taken when the lamp is turned on, using new batteries. Lighting distance depends directly on brightness, but mainly on the shape of the beam.



RESERVE
LIGHTING

Reserve lighting (outside of the ANSI/PLATO FL 1 protocol)

In addition to these measures, Petzl guarantees reserve lighting. Reserve lighting ensures a minimum light level to be able to move around. However, the lighting may be insufficient for certain activities (such as precision work, inspection...).

The IP Protection Index



A headlamp's resistance to solids and/or liquids is indicated by its IP rating. This index classifies the level of protection offered by equipment against intrusions by solids (e.g. dust) and liquids (e.g. water, oil).

Understanding the protection index

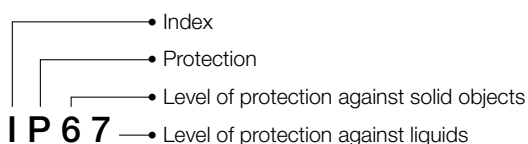

Protection against solid objects

X = Not measured

0 = Not protected

1 = Protected against projection of solids \geq 50 mm in diameter

2 = Protected against projection of solids \geq 12.5 mm in diameter

3 = Protected against projection of solids \geq 2.5 mm in diameter

4 = Protected against projection of solids \geq 1 mm in diameter

5 = Protected against dust (limited ingress, no harmful deposits)

6 = Completely protected against dust

Protection against liquids

X = Not measured

0 = Not protected

1 = Protected against vertically falling water drops

2 = Protected against water drops (15° from vertical)

3 = Protected against rain (60° from vertical)

4 = Protected against splashing water

5 = Protected against water jets

6 = Protected against powerful water jets













7 = Temporary immersion (-1 meter for 30 minutes)

8 = Prolonged immersion (deeper than 1 meter for period defined by manufacturer)

9 = Prolonged immersion (deeper than 1 meter) and protection against pressure-washing

Environments and standards

Choosing your Petzl headlamp for hazardous areas in accordance with regulations:

		 ATEX	 HAZLOC	 WATER-PROOF	 BATTERIES INCLUDED	 RECHARGEABLE
DUO Z1		E80BHR E80BHR UK	ATEX zone 1/21 II 2 GD Ex ib IIB T4 Gb IIIB T135° C Db Ambient temperature: -20° C to +40° C	-	•	-
						•
DUO Z2		E80AHB	ATEX zone 2/22 II 3 GD Ex ic IIB T4 Gc IIIB T135° C Dc Ambient temperature: -20° C to +40° C	-	•	•
PIXA Z1		E78DHB 2	ATEX zone 1/21 II 2 GD Ex ib IIB T4 Gb IIIB T135° C Db Ambient temperature: -20° C to +40° C	-	•	•
PIXA 3R		E78CHR 2 E78CHR 2UK	ATEX zone 2/22 II 3 GD Ex ic IIB T4 Gc IIIC T135° C Dc Ambient temperature: -30° C to +40° C	-	•	-
PIXA 3		E78CHB 2	ATEX zone 2/22 II 3 G Ex nA ic IIB T4 Gc, II 3 D Ex to IIIC T135° C Dc Ambient temperature: -30° C to +40° C	-	•	•
		E78CHB 2UL	-	HAZLOC Class I Div 2 Groups C, D Class II Div 2 Group G Temperature code T4 Ambient temperature: -30° C to +40° C	•	•
PIXA 2		E78BHB 2	ATEX zone 2/22 II 3 G Ex nA ic IIB T4 Gc, II 3 D Ex to IIIC T135° C Dc Ambient temperature: -30° C to +40° C	-	•	•
		E78BHB 2UL	-	HAZLOC Class I Div 2 Groups C, D Class II Div 2 Group G Temperature code T4 Ambient temperature: -30° C to +40° C	•	•
PIXA 1		E78AHB 2	ATEX zone 2/22 II 3 G Ex nA ic IIB T4 Gc, II 3 D Ex to IIIC T135° C Dc Ambient temperature: -30° C to +40° C	-	•	•
		E78AHB 2UL	-	HAZLOC Class I Div 2 Groups C, D Class II Div 2 Group G Temperature code T4 Ambient temperature: -30° C to +40° C	•	•



Brightness is the total quantity of light emitted by a lamp. It is expressed in lumens. The greater the quantity of light, the better you see. The value indicated is that of the most powerful lighting level (MAX POWER).



LOCK function to avoid accidentally turning it on during transit or storage.



Lighting distance is linked to brightness and beam shape. It is expressed in meters and indicates the range of usable lighting. The value indicated is the maximum value.



Petzl headlamps that work with rechargeable batteries.



Burn time expresses the length of time a headlamp functions with power sufficient for carrying out an activity. It is expressed in hours. The value indicated is the maximum value.



Petzl headlamps that work with regular batteries (included).



When the batteries are almost drained, the headlamp switches automatically to reserve lighting to guarantee minimum lighting for several hours.



Headlamp meeting ATEX certification requirements for work in hazardous environments.



Flood beam designed for proximity lighting, to see up close or around the feet. The wide angle provides a very wide and comfortable field of vision.

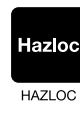

Headlamp meeting HAZLOC certification requirements for work in hazardous environments.



Mixed beam consists of a flood beam and a focused component, allowing both proximity lighting and longer-range vision for moving around.



Better resistance to chemicals.



Narrow beam allows focused lighting on a target in order to see objects or people at a distance.



The IP rating on a headlamp guarantees its degree of resistance to intrusions:
IPX4: water-spray and weather resistant
IPX7: resistant to temporary immersion (-1 meter for 30 minutes)
IP67: resistant to dust and temporary immersion (to 1 meter for 30 minutes)

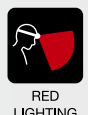

Red lighting for more comfortable night vision. This lighting allows good vision without blinding the user or members of a group.

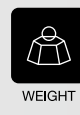

The weight indicated is that of the headlamp with its energy source (regular or rechargeable batteries).



Red, green and blue lighting allows the user to better see contrasts in the lit object in certain situations.



Resistance to falls (2 m).













Red and/or white strobe lighting allows you to signal and be more easily located, for example in an emergency.



Resistance to crushing (80 kg).

Headlamp specifications

									
STANDARD LIGHTING	CONSTANT LIGHTING	REACTIVE LIGHTING®	MAX BRIGHTNESS	MAX DISTANCE	MAX BURN TIME	RESERVE LIGHTING	LARGE	MIXED	FOCUSED
ANSI/PLATO FL 1									

Performance headlamps

NEW 2021		-	•	•	3000 lm	255 m	24 h	•	•	•	•
DUO RL											
DUO S		-	•	-	1100 lm	200 m	23 h	•	•	•	•
DUO Z1		-	•	-	360 lm	115 m	23 h	•	•	•	•
DUO Z2		-	•	-	430 lm	120 m	15 h 30	•	•	•	•

Compact, durable lamps

PIXA Z1		•	-	-	100 lm	95 m	56 h	•	•	•	•
PIXA 3R		-	•	-	90 lm	90 m	11 h 30	•	•	•	•
PIXA 3		-	•	-	100 lm	90 m	26 h	•	•	•	•
PIXA 2		-	•	-	80 lm	55 m	26 h	•	-	•	-
PIXA 1		-	•	-	60 lm	15 m	16 h	•	•	-	-

Ultra-compact headlamps

SWIFT RL PRO		•	-	•	900 lm	150 m	100 h	•	-	•	•
TACTIKKA CORE		•	-	-	450 lm	90 m	130 h	•	•	•	-
TACTIKKA +RGB		•	-	-	350 lm	90 m	160 h	•	-	•	-
TACTIKKA +		•	-	-	350 lm	90 m	160 h	•	-	•	-
TACTIKKA		•	-	-	300 lm	65 m	120 h	•	•	-	-
TACTIKKA ADAPT											
e+LITE		•	-	-	30 lm	7 m	11 h 30	-	•	-	-



RED LIGHTING



RGB LIGHTING



WHITE / RED STROBE



FACE2FACE FUNCTION



LOCK UNLOCK



HYBRID CONCEPT



RECHARGEABLE



BATTERIES INCLUDED



ATEX



HAZLOC



INGRESS PROTECTION



WEIGHT

-	-	-	-	•	-	• wall	-	-	-	-	IP67	390 g
-	-	-	•	•	-	• wall	-	-	-	-	IP67	370 g
-	-	-	•	•	-	• wall	-	-	ATEX zone 1/21 II 2 GD Ex ib IIB T4 Gb IIIB T135° C Db Ambient temperature: -20° C to +40° C	-	IP67	370 g
-	-	-	•	•	-	-	-	4 x AALR06	ATEX zone 2/22 II 3 GD Ex ic IIB T4 Gc IIIB T135° C Dc Ambient temperature: -20° C to +40° C	-	IP67	360 g
-	-	-	-	•	-	-	-	2 x AALR06	ATEX zone 1/21 II 2 GD Ex ib IIB T4 Gb IIIB T135° C Db Ambient temperature: -20° C to +40° C	-	IP67	170 g
-	-	-	-	•	-	• wall	-	-	ATEX zone 2/22 II 3 GD Ex ic IIB T4 Gc IIIC T135° C Dc Ambient temperature: -30° C to +40° C	-	IP67	145 g
-	-	-	-	•	-	-	-	2 x AALR06	ATEX zone 2/22 II 3 G Ex nA ic IIB T4 Gc II 3 D Ex tc IIIC T135° C Dc Ambient temperature: -30° C to +40° C	HAZLOC Class I Div 2 Groups C, D Class II Div 2 Group G Temperature code T4 Ambient temperature: -30° C to +40° C	IP67	160 g
-	-	-	-	•	-	-	-	2 x AALR06			IP67	160 g
-	-	-	-	•	-	-	-	2 x AALR06			IP67	160 g
•	-	-	-	•	-	• USB	-	-	-	-	IPX4	123 g
•	-	• red	-	-	•	• USB	-	-	-	-	IPX4	77 g
•	•	• RGB	-	-	•	-	-	3 x AAA LR03	-	-	IPX4	85 g
•	-	• red	-	-	•	-	-	3 x AAALR03	-	-	IPX4	85 g
•	-	• red	-	-	•	-	-	3 x AAALR03	-	-	IPX4	82 g
												70 g 73 g
•	-	• white red	-	•	-	-	-	2 x lithium CR2032	-	-	IPX7	26 g

PERFORMANCE HEADLAMPS

Durable and powerful, they are designed for intensive use in industry, maintenance, inspection and rescue.

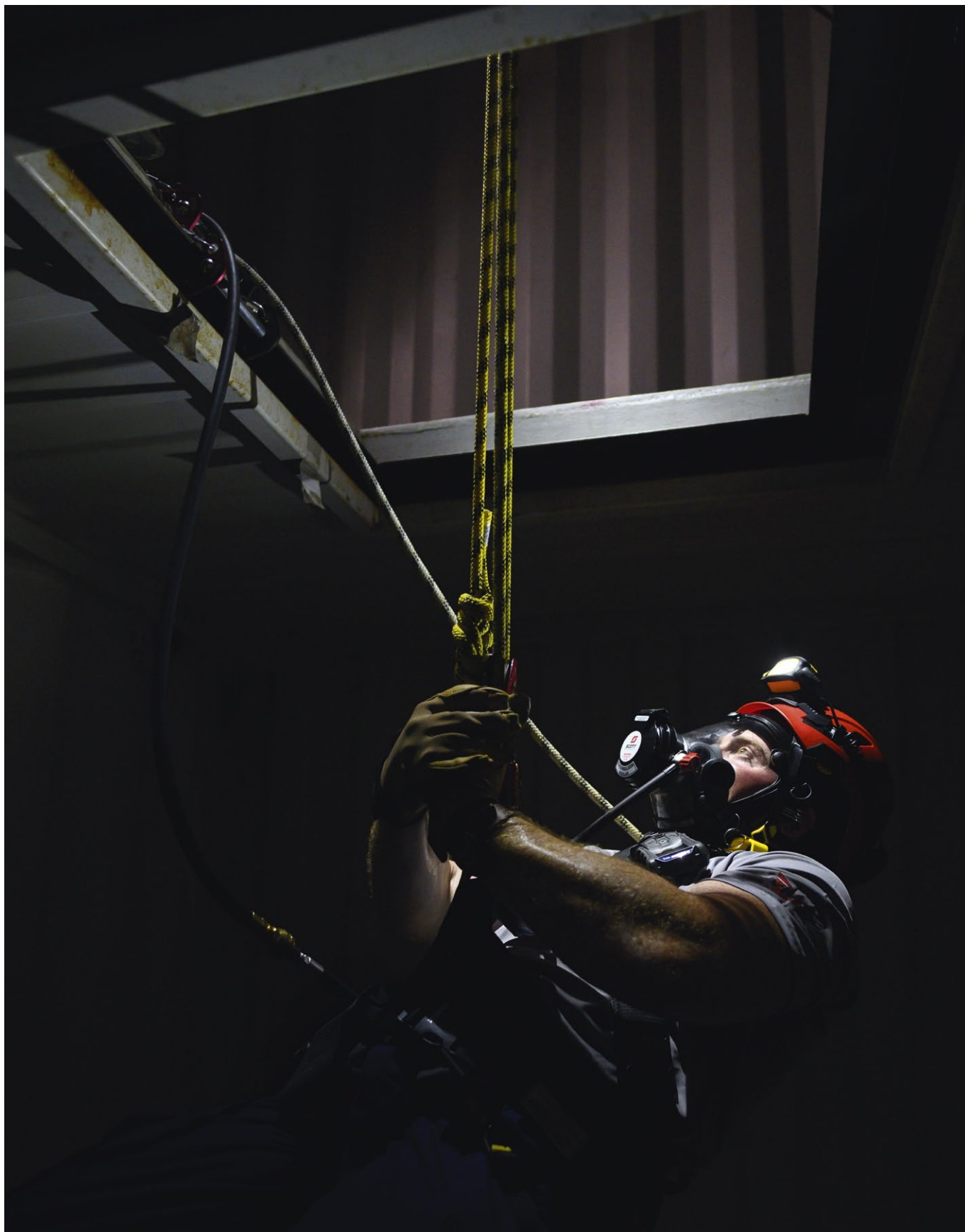

Evacuation exercise in a confined space, Baton Rouge, Louisiana, USA © 2020 Petzl Distribution - James Roh

DUO RL

Ultra-powerful, rechargeable multi-beam headlamp featuring REACTIVE LIGHTING® technology. 3000 lumens



DUO S

Ultra-powerful, rechargeable multi-beam headlamp, featuring the FACE2FACE anti-glare function. 1100 lumens



DUO Z1

Powerful, rechargeable multi-beam headlamp with FACE2FACE anti-glare function, certified for use in ATEX hazardous areas. 360 lumens



DUO Z2

Powerful multi-beam headlamp that runs on standard batteries, with FACE2FACE anti-glare function, for use in ATEX hazardous areas. 430 lumens



Accessories



ACCU 2 DUO Z1



ACCU 2



5 DUO Z1 charging rack



ACCU 2 DUO Z1 charger



Quick charger



Extension cord for headlamp



PRO ADAPT



NEW
2021



3000 lm
MAX
BRIGHTNESS



255 m
MAX
DISTANCE



24 h
MAX
BURN TIME

DUO RL

Ultra-powerful, rechargeable multi-beam headlamp featuring REACTIVE LIGHTING® technology. 3000 lumens

Designed for technical rescue and for worksites, the DUO RL rechargeable headlamp provides 3000-lumen brightness. With its REACTIVE LIGHTING® technology, a sensor analyzes the ambient light and automatically adjusts brightness to user requirements. Manual operation is minimized and burn time is optimized, so the user can remain focused on the activity. The aluminum lamp body provides excellent impact resistance. The DUO RL is waterproof, ideal for use in wet environments.



Longer burn time, greater visual comfort and less manual operation with REACTIVE LIGHTING® mode: the light sensor automatically adjusts brightness and beam pattern, optimizing battery life.



IP
67
INGRESS
PROTECTION

Dustproof, and waterproof to -3 meters for 30 minutes in fresh water.



Ultra-bright with 3000 lumens and multi-beam lighting to suit any situation.



Aluminum lamp body provides excellent resistance to falls, impacts and crushing.



ACCU 2 rechargeable 3200 mAh Lithium-Ion battery with four-level gauge, for precise monitoring of battery charge level.



Technical rescue training with GRIMP 30, Nîmes, France © 2020 - Petzl Distribution - Vuedici.org - GRIMP 30 - VATEL



- **Guaranteed lighting over time**



CONSTANT LIGHTING

CONSTANT LIGHTING technology allows lighting to remain stable as the batteries drain. When the batteries are almost drained, the headlamp switches automatically to low-level reserve lighting, to extend burn time.

- **ATEX certified lamps for use in hazardous areas**



ATEX

Designed to withstand the harshest environments, DUO headlamps can be used in hazardous areas. Depending on the model, they are certified ATEX zone 1/21 or zone 2/22 (except DUO S).

Learn about choosing the ATEX headlamp that best meets your needs, page 166.

- **Efficiency and comfort when working in a group**

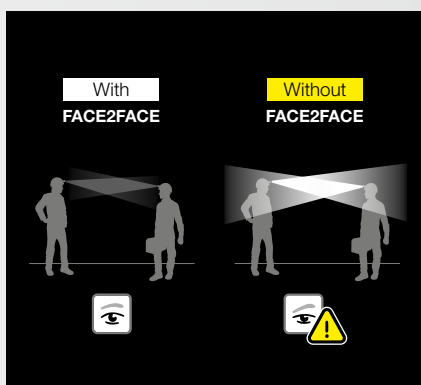

FACE2FACE FUNCTION

The FACE2FACE function allows users to be face-to-face without blinding one another. Once activated, it triggers a sensor that detects other DUO headlamps within 8 meters and automatically dims the lighting if they face each other. The light returns to its original intensity once the other headlamp is no longer in its line of sight.



- **Powerful multi-beam lamps**



DUO headlamps have a multi-beam with several lighting modes, to adapt to any situation: convenient lighting for proximity, movement and long-range vision. BOOST mode allows temporary access to maximum brightness.

- **Comfort, ergonomics and durability**



Rotary switch can be operated with gloves to facilitate access to different lighting modes under any conditions. DUO headlamps are durable and perfectly suited for work in harsh industrial environments, under difficult conditions (rain, snow, mud, ice...).

- **Ultra-powerful lighting that runs on rechargeable battery**



- **Powerful lighting that runs on rechargeable battery**



- **Powerful lighting that runs on regular batteries**





BOOST

1100 lm

MAX BRIGHTNESS

200 m

MAX DISTANCE

23 h

MAX BURN TIME

DUO S

Ultra-powerful, rechargeable multi-beam headlamp, featuring the FACE2FACE anti-glare function. 1100 lumens

Ultra-powerful with 1100 lumens in BOOST mode, the DUO S runs on a rechargeable battery. It is multi-beam, and has five lighting modes, making it adaptable to every situation: close-range work, proximity, movement, rapid movement and long-range vision. Featuring the FACE2FACE anti-glare function, the DUO S headlamp allows those working in a group to face each other without blinding one another, to work together more effectively. It can be worn on VERTEX and STRATO helmets, thanks to the included mounting plates.



BOOST

360 lm

MAX BRIGHTNESS

115 m

MAX DISTANCE

23 h

MAX BURN TIME

DUO Z1

Powerful, rechargeable multi-beam headlamp with FACE2FACE anti-glare function, certified for use in ATEX hazardous areas. 360 lumens

DUO Z1 is a headlamp with a maximum 360 lumens of lighting in BOOST mode that runs on a rechargeable battery. It is multi-beam, and has four lighting modes, making it adaptable to every situation: close-range work, proximity lighting, movement and long-range vision. Featuring the FACE2FACE anti-glare function, the DUO Z1 headlamp allows those working in a group to face each other without blinding one another, enabling them to work more effectively together. It can be worn on VERTEX and STRATO helmets, thanks to the included mounting plates. It meets ATEX zone 1/21 (II 2 GD Ex ib IIB T4 Gb IIIB T135° C Db) certification requirements for work in hazardous areas.

x5



+



Pack of 5 DUO Z1

Pack of 5 DUO Z1 headlamps with charging rack

Pack of five DUO Z1 headlamps - comes with charging rack that allows simultaneous charging of five batteries.



BOOST

430 lm

MAX BRIGHTNESS

120 m

MAX DISTANCE

15 h 30

MAX BURN TIME

DUO Z2

Powerful multi-beam headlamp that runs on standard batteries, with FACE2FACE anti-glare function, for use in ATEX hazardous areas. 430 lumens

The DUO Z2 headlamp provides a powerful 430 lumens in BOOST mode, and runs on regular batteries. It is multi-beam, and has four lighting modes, making it adaptable to every situation: close-range work, proximity lighting, movement and long-range vision. Featuring the FACE2FACE anti-glare function, the DUO Z2 headlamp allows those working in a group to face each other without blinding one another, enabling them to work more effectively together. It can be worn on VERTEX and STRATO helmets, thanks to the included mounting plates. It meets ATEX zone 2/22 (II 3 GD Ex ic IIB T4 Gc IIIB T135° C Dc) certification requirements for work in hazardous areas.





ACCU 2 DUO Z1

Rechargeable battery for DUO Z1 headlamp, usable in ATEX zone

Very high-capacity rechargeable battery, 23.68 Wh, designed for the DUO Z1 headlamp. Durable and ATEX zone 1/21 (II 2 GD Ex ib IIB T4 Gb IIIB T135° C Db) certified, it also features quick connection to the headlamp and an energy gauge for monitoring the battery's charge level.



ACCU 2

Rechargeable battery for DUO RL and DUO S headlamps

High-performance rechargeable battery designed for DUO RL and DUO S headlamps. It is rugged, and features quick connection to the headlamp and an energy gauge for monitoring the battery's charge level.



5 DUO Z1 charging rack

Charging rack, which allows simultaneous charging of five DUO Z1 headlamp batteries

EUR/US/UK compatible charging rack allows simultaneous charging of up to five ACCU 2 DUO Z1 rechargeable batteries.



ACCU 2 DUO Z1 charger

Wall charger for ACCU 2 DUO Z1 rechargeable battery

EUR/US compatible quick wall charger for ACCU 2 DUO Z1 rechargeable battery.



Quick charger

Quick wall charger for ACCU 2 rechargeable batteries

Compatible quick wall charger for ACCU 2 rechargeable battery. Available in two versions: EUR/US compatible or UK compatible.



Extension cord for headlamp

Extension cord for DUO RL and DUO S headlamps

The extension cord for DUO RL and DUO S headlamps allows the user to reduce the amount of weight on the head by moving the rechargeable battery to a pocket or onto the back with the harness.



PRO ADAPT

Adhesive accessory for mounting a DUO headlamp on any type of helmet

PRO ADAPT consists of two adhesive plates for mounting a DUO RL, DUO S, DUO Z1 or DUO Z2 headlamp on a helmet, while retaining the ability to tilt the lamp. The system is especially resistant to impacts and moisture.

				ANSI/PLATO FL 1					
		CONSTANT LIGHTING	REACTIVE LIGHTING®	Lighting modes	MAX BRIGHTNESS	MAX DISTANCE	MAX BURN TIME	WEIGHT	
 DUO RL E103AA00 <small>NEW 2021</small>	CE	-	●	Proximity (2)	25 - 120 lm	18 m	24 - 72 h	390 g	
				Movement (2)	50 - 250 lm	32 m	12 - 38 h		
				Rapid movement (2)	100 - 600 lm	75 m	6 - 24 h		
				Maximum power (2)	150 - 3000 lm	255 m	1 h 30 - 18 h		
				Focused (2)	100 - 1000 lm	235 m	3 - 24 h		
		●	-	Proximity (2)	100 lm	16 m	24 h		
				Movement (2)	250 lm	32 m	12 h		
				Rapid movement (2)	500 lm	70 m	6 h		
				Maximum power (2)	2000 lm	200 m	1 h 30		
				Focused (2)	800 lm	230 m	3 h		
		-	-	Survival mode: low	25 lm	8 m	78 h		
				Survival mode: high	120 lm	26 m	24 h		
				Close-range work	80 lm	20 m	23 h		370 g
				Proximity	180 lm	35 m	12 h 30		
				Movement	330 lm	70 m	6 h		
Rapid movement	700 lm	160 m	3 h 30						
Distance vision	450 lm	190 m	4 h 30						
BOOST mode	1100 lm	200 m	-						
Reserve lighting	20 lm for 45 min								
 DUO Z1 E80BHR E80BHR UK E80DHR (Pack of 5 DUO Z1)	CE ATEX zone 1/21 II 2 GD Ex ib IIB T4 Gb IIIB T135° C Db Ambient temperature: -20° C to +40° C	●	-	Close-range work	70 lm	20 m	23 h	370 g	
				Proximity	170 lm	35 m	12 h		
				Movement	300 lm	90 m	7 h		
				Distance vision	140 lm	100 m	17 h		
				BOOST mode	360 lm	115 m	-		
				Reserve lighting	10 lm for 1 h 30				
 DUO Z2 E80AHB	CE ATEX zone 2/22 II 3 GD Ex ic IIB T4 Gc IIIB T135° C Dc Ambient temperature: -20° C to +40° C (1)	●	-	Close-range work	50 lm	17 m	15 h 30	360 g	
				Proximity	120 lm	30 m	6 h 45		
				Movement	220 lm	80 m	2 h		
				Distance vision	180 lm	120 m	2 h 45		
				BOOST mode	430 lm	115 m	-		
				Reserve lighting	10 lm for 1 h				

(1) Certifications guaranteed only with alkaline batteries, (2) Factory setting, programmable by user.

Accessories

		Weight
ACCU 2 DUO Z1	E80001	168 g
ACCU 2	E80002	168 g
5 DUO Z1 charging rack	E80003	1440 g
ACCU 2 DUO Z1 charger	E080AA00	170 g
Quick charger	E55800 / E55800 UK	145 g
Extension cord for headlamp	E55950	75 g
PRO ADAPT	E80004	48 g

Lighting specifications are subject to change; check www.petzl.com



COMPACT, DURABLE HEADLAMPS

Headlamps designed for frequent use, for the energy, networks, building, and maintenance markets.



Wind turbine maintenance on a wind farm in Vallée de l'Arce, France © 2020 Petzl distribution - Vuedici.org - Boralex SAS

PIXA Z1

Headlamp for use in ATEX hazardous areas, suitable for proximity lighting, movement and long-range vision. 100 lumens



PIXA 3R

Rechargeable headlamp for use in ATEX hazardous areas, suitable for proximity lighting, movement and long-range vision. 90 lumens



PIXA 3

Headlamp for proximity lighting, movement and long-range vision. Available in ATEX or HAZLOC versions. 100 lumens



PIXA 2

Headlamp suitable for proximity lighting and movement. Available in ATEX or HAZLOC versions. 80 lumens



PIXA 1

Headlamp for proximity lighting. Available in ATEX or HAZLOC versions. 60 lumens



Accessories



PIXADAPT



RUBBER



Rechargeable battery for PIXA 3R



POCHE PIXA and SWIFT RL PRO



- **Guaranteed lighting over time**



CONSTANT LIGHTING

CONSTANT LIGHTING technology allows lighting to remain stable as the batteries drain. When the batteries are almost drained, the headlamp switches automatically to low-level reserve lighting, to extend burn time (except PIXA Z1).

- **Lamps for use in hazardous areas: ATEX or HAZLOC certification**



ATEX

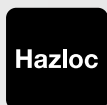

HAZLOC

Designed to withstand the harshest environments, PIXA headlamps can be used in explosive atmospheres. Depending on the model, they are certified ATEX or HAZLOC.

Learn about choosing the ATEX or HAZLOC headlamp that best meets your needs, page 166.

- **Rugged, durable construction**



Lockable rotary switch

Easy to use, even when wearing gloves. May be locked to prevent inadvertently turning on the light, with a storage position that protects the lens.



Great mechanical strength

Shocks, falls, crushing: these lamps endure the daily rigors of a professional work site.



Waterproof and chemical resistant

PIXA headlamps are waterproof (IP67) and have been tested for resistance to various chemicals.

- **For close-range work, movement, and long-range vision**



LARGE



MIXED



FOCUSED

- **For close-range work and movement**



MIXED

- **For close-range work**



LARGE



100 lm

MAX BRIGHTNESS



95 m

MAX DISTANCE



56 h

MAX BURN TIME

PIXA® Z1

Headlamp for use in ATEX hazardous areas, suitable for proximity lighting, movement and long-range vision. 100 lumens

The PIXA Z1 headlamp is durable and versatile. The multi-beam adapts to all situations: close-range work, movement, and long-range vision. It meets ATEX zone 1/21 (II 2 GD Ex ib IIB T4 Gb IIIB T135° C Db) certification requirements for work in hazardous areas.



90 lm

MAX BRIGHTNESS



90 m

MAX DISTANCE



11 h 30

MAX BURN TIME

PIXA® 3R

Rechargeable headlamp for use in ATEX hazardous areas, suitable for proximity lighting, movement and long-range vision. 90 lumens

The PIXA 3R headlamp is a durable, rechargeable headlamp suitable for frequent use by professionals. The multi-beam adapts to all situations: close-range work, movement, and long-range vision. CONSTANT LIGHTING technology: brightness does not gradually decrease as the batteries are drained. It meets ATEX zone 2/22 (II 3 GD Ex ic IIB T4 Gc IIIC T135° C Dc) certification requirements for work in hazardous areas.



100 lm

MAX BRIGHTNESS



90 m

MAX DISTANCE



26 h

MAX BURN TIME

PIXA® 3

Headlamp for proximity lighting, movement and long-range vision. Available in ATEX or HAZLOC versions. 100 lumens

The PIXA 3 headlamp is durable and versatile. The multi-beam adapts to all situations: close-range work, movement, and long-range vision. CONSTANT LIGHTING technology: brightness does not decrease gradually as the batteries are drained. Available in two versions: ATEX zone 2/22 (II 3 GD Ex nA ic IIB T4 Gc tc, IIIC T135° C Dc) or HAZLOC (Class I Div 2 Groups C, D and Class II Div 2 Group G, T4).



80 lm

MAX BRIGHTNESS



55 m

MAX DISTANCE



26 h

MAX BURN TIME

PIXA® 2

Headlamp suitable for proximity lighting and movement. Available in ATEX or HAZLOC versions. 80 lumens

The PIXA 2 is a durable headlamp offering lighting that allows the user to work comfortably on tasks close at hand or to move around safely. CONSTANT LIGHTING technology: brightness does not decrease gradually as the batteries are drained. Available in two versions: ATEX zone 2/22 (II 3 GD Ex nA ic IIB T4 Gc tc, IIIC T135° C Dc) or HAZLOC (Class I Div 2 Groups C, D and Class II Div 2 Group G, T4).



60 lm

MAX BRIGHTNESS



15 m

MAX DISTANCE



16 h

MAX BURN TIME

PIXA® 1

Headlamp for proximity lighting. Available in ATEX or HAZLOC versions. 60 lumens

The PIXA 1 is a durable headlamp offering lighting that allows the user to work comfortably on tasks close at hand. CONSTANT LIGHTING technology: brightness does not decrease gradually as the batteries are drained. Available in two versions: ATEX zone 2/22 (II 3 GD Ex nA ic IIB T4 Gc tc, IIIC T135° C Dc) or HAZLOC (Class I Div 2 Groups C, D and Class II Div 2 Group G, T4).



Compact, durable headlamps

Accessories



PIXADAPT

Accessory for mounting a PIXA or SWIFT RL PRO headlamp on a helmet

The PIXADAPT is a part that allows the user to mount or unmount a PIXA or SWIFT RL PRO headlamp on a helmet anytime, while retaining the ability to tilt the lamp. PIXADAPT is compatible with Petzl helmets with or without eye shield. For other helmets, verify compatibility with the helmet manufacturer.



RUBBER

Rubber headband for PIXA or SWIFT RL PRO headlamp, compatible with all helmet types

The RUBBER headband adapts to all helmets on the market and holds a PIXA or SWIFT RL PRO headlamp securely in position.



Rechargeable battery for PIXA® 3R

930 mAh Lithium-Ion Polymer rechargeable battery

Rechargeable Lithium-Ion polymer battery, 930 mAh, recharges separately or on the headlamp, for quick charge.



POCHE PIXA® & SWIFT® RL PRO

Carry pouch for PIXA and SWIFT RL PRO headlamps

Accessories		Weight
PIXADAPT	E78005	20 g
RUBBER	E78002	-
Rechargeable battery for PIXA 3R	E78003	37 g
POCHE PIXA & SWIFT RL PRO	E78001	44 g

				ANSI/PLATO FL 1				
				Lighting modes			WEIGHT	
				MAX BRIGHTNESS	MAX DISTANCE	MAX BURN TIME		
		CONSTANT LIGHTING						
 PIXA Z1	E78DHB 2	CE ATEX zone 1/21 II 2 GD Ex ib IIB T4 Gb IIIB T135° C Db Ambient temperature: -20° C to +40° C (1)	-	Close-range work	30 lm	15 m	56 h	170 g
				Movement	70 lm	50 m	23 h	
				Distance vision	100 lm	95 m	16 h	
				Reserve lighting	5 lm for 20 h			
 PIXA 3R	E78CHR 2 E78CHR 2UK	CE ATEX zone 2/22 II 3 GD Ex ic IIB T4 Gc IIIC T135° C Dc Ambient temperature: -30° C to +40° C	•	STANDARD setting				145 g
				Close-range work	20 lm	15 m	11 h 30	
				Movement	55 lm	45 m	5 h	
				Distance vision	90 lm	90 m	3 h 30	
				Reserve lighting	10 lm for 1 h 30			
				MAX AUTONOMY setting				
				Close-range work	20 lm	15 m	11 h 30	
				Movement	20 lm	30 m	11 h 30	
				Distance vision	20 lm	50 m	11 h 30	
				Reserve lighting	10 lm for 1 h 30			
				MAX POWER setting				
				Close-range work	90 lm	25 m	3 h	
			Movement	90 lm	55 m	3 h		
			Distance vision	90 lm	90 m	3 h 30		
			Reserve lighting	10 lm for 1 h 30				
 PIXA 3	E78CHB 2	CE ATEX zone 2/22 II 3 G Ex nA ic IIB T4 Gc, II 3 D Ex tc IIIC T135° C Dc Ambient temperature: -30° C to +40° C (1)	•	Close-range work	20 lm	15 m	26 h	160 g
				Movement	60 lm	45 m	6 h 30	
				Distance vision	100 lm	90 m	3 h 30	
				Reserve lighting	10 lm for 13 h			
	E78CHB 2UL	CE HAZLOC Class I Div 2 Groups C, D Class II Div 2 Group G Temperature code T4 Ambient temperature: -30° C to +40° C (1)						
 PIXA 2	E78BHB 2	CE ATEX zone 2/22 II 3 G Ex nA ic IIB T4 Gc, II 3 D Ex tc IIIC T135° C Dc Ambient temperature: -30° C to +40° C (1)	•	Close-range work	20 lm	25 m	26 h	160 g
				Movement	80 lm	55 m	3 h 30	
				Reserve lighting	10 lm for 13 h			
		E78BHB 2UL	CE HAZLOC Class I Div 2 Groups C, D Class II Div 2 Group G Temperature code T4 Ambient temperature: -30° C to +40° C (1)					
 PIXA 1	E78AHB 2	CE ATEX zone 2/22 II 3 G Ex nA ic IIB T4 Gc, II 3 D Ex tc IIIC T135° C Dc Ambient temperature: -30° C to +40° C (1)	•	Close-range work	20 lm	10 m	16 h	160 g
				Movement	60 lm	15 m	3 h 30	
				Reserve lighting	10 lm for 6 h 30			
		E78AHB 2UL	CE HAZLOC Class I Div 2 Groups C, D Class II Div 2 Group G Temperature code T4 Ambient temperature: -30° C to +40° C (1)					

(1) Certifications guaranteed only with alkaline batteries

Lighting specifications are subject to change: check www.petzl.com



ULTRA-COMPACT HEADLAMPS

Practical, lightweight headlamps, for occasional to frequent use, for professionals working at concerts and shows, in workshops, on small maintenance jobs...



Maintenance inside excavated underground galleries © 2020 Petzl Distribution - Rémi Flament - SAS MICHEL BESSON

SWIFT RL PRO

Ultra-powerful, lightweight rechargeable headlamp with multi-beam and REACTIVE LIGHTING® technology for proximity and distance vision. White lighting, or red to ensure stealth. 900 lumens



TACTIKKA CORE

Compact rechargeable headlamp with multi-beam, for proximity and distance vision. White lighting, or red to ensure stealth. 450 lumens



TACTIKKA +RGB

Compact headlamp with mixed beam for proximity and distance vision. White or red/green/blue lighting to ensure stealth. 350 lumens



TACTIKKA +

Compact headlamp with mixed beam for proximity and distance vision. White lighting, or red to ensure stealth. 350 lumens



TACTIKKA

Compact headlamp with flood beam for proximity lighting. White lighting, or red to ensure stealth. 300 lumens



TACTIKKA ADAPT

TACTIKKA headlamp without headband and with mounts for use on any type of helmet. 300 lumens



e+LITE

Ultra-compact emergency headlamp. 30 lumens



Accessories



ACCU SWIFT RL PRO



POCHE PIXA & SWIFT RL PRO



PIXADAPT



RUBBER



CORE



FIXATION TACTIKKA



KIT ADAPT



SHELL L





SWIFT® RL PRO

Ultra-powerful, lightweight rechargeable headlamp with multi-beam and REACTIVE LIGHTING® technology for proximity and distance vision. White lighting, or red to ensure stealth. 900 lumens

Designed for the workshop, small maintenance jobs, or concerts and shows, the SWIFT RL PRO rechargeable headlamp provides 900-lumen brightness. With its REACTIVE LIGHTING® technology, a sensor analyzes the ambient light and automatically adjusts brightness to user requirements. It also has red lighting to ensure stealth. SWIFT RL PRO is intuitive, with a single button for easy control over all lamp functions. The five-level gauge allows precise monitoring of the battery charge level. The lamp is compatible with Petzl helmets, and mounting accessories allow it to be attached to any kind of helmet.



Longer burn time, greater visual comfort and less manual operation with REACTIVE LIGHTING® mode: the light sensor automatically adjusts brightness and beam pattern, optimizing battery life.



Ultra-bright and lightweight: 900 lumens for a weight of only 123 g.



SWIFT RL PRO is compatible with Petzl helmets. Mounting accessories allow the lamp to be attached to any kind of helmet.

Accessories



ACCU SWIFT® RL PRO

Rechargeable battery for SWIFT RL PRO headlamp

High-capacity Lithium-Ion 2350 mAh rechargeable battery for the SWIFT RL PRO headlamp. It guarantees excellent lighting performance, even at low temperatures. It charges directly via built-in micro USB port and has a charging indicator light.



POCHE PIXA® & SWIFT® RL PRO

Carry pouch for PIXA and SWIFT RL PRO headlamps



PIXADAPT

Accessory for mounting a PIXA or SWIFT RL PRO headlamp on a helmet

The PIXADAPT is a part that allows the user to mount or unmount a PIXA or SWIFT RL PRO headlamp on a helmet anytime, while retaining the ability to tilt the lamp. PIXADAPT is compatible with Petzl helmets with or without eye shield. For other helmets, verify compatibility with the helmet manufacturer.



RUBBER

Rubber headband for PIXA or SWIFT RL PRO headlamp, compatible with all helmet types

The RUBBER headband adapts to all helmets on the market and holds a PIXA or SWIFT RL PRO headlamp securely in position.



• Lighting technologies



STANDARD LIGHTING

STANDARD LIGHTING

STANDARD LIGHTING technology offers an ideal compromise between power and burn time. Brightness decreases gradually as the batteries are drained.

• Simple to use



Ultra-compact headlamps are simple to use, thanks to the single ergonomic button that allows quick and easy access to functions: ON/OFF, lighting modes, levels and colors.

• Several beam types and lighting levels



Ultra-compact headlamps have different beam types: flood for close-range work, mixed for moving around or focused for distance vision. The lighting levels allow brightness and burn time to be adjusted as needed.

• Red lighting



RED LIGHTING

Ultra-compact headlamps have red lighting to preserve night vision and stealth.

• Choose your energy source



HYBRID CONCEPT

Ultra-compact headlamps work equally well with the CORE rechargeable battery and with three AAA/LR03 batteries, without an adapter. A practical and flexible solution for managing energy requirements.

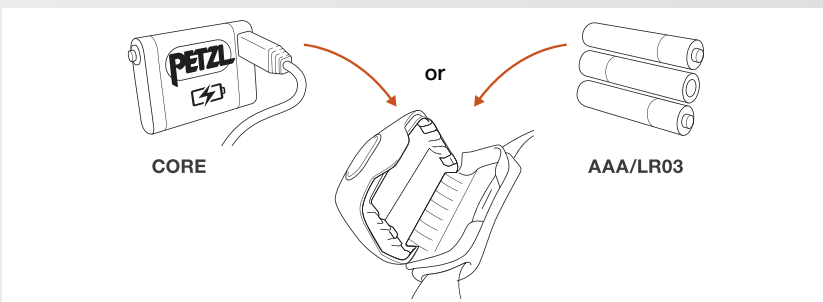

• For frequent use

• For occasional use



RGB LIGHTING

With red, green, blue lighting



RED LIGHTING

With red lighting



TACTIKKA® CORE

Compact rechargeable headlamp with multi-beam, for proximity and distance vision. White lighting, or red to ensure stealth. 450 lumens

Designed for the workshop, small maintenance jobs, or concerts and shows, the TACTIKKA CORE headlamp provides 450-lumen brightness. It is multi-beam, guaranteeing comfortable proximity lighting and strong performance lighting for rapid movement and distance vision. It also has red lighting to ensure stealth. Thanks to its HYBRID CONCEPT design, TACTIKKA CORE comes with the CORE rechargeable battery and is also compatible with three AAA/LR03 batteries (not included). Mounting accessories allow the lamp to be attached to any kind of helmet.



TACTIKKA® +RGB

Compact headlamp with mixed beam for proximity and distance vision. White or red/green/blue lighting to ensure stealth. 350 lumens

Designed for the workshop, small maintenance jobs, or concerts and shows, the TACTIKKA +RGB headlamp provides 350-lumen brightness and a mixed beam, for comfortable proximity lighting and rapid movement. It also has red, green or blue lighting to ensure stealth. TACTIKKA +RGB comes with 3 standard batteries and is also compatible with the CORE rechargeable battery, thanks to its HYBRID CONCEPT design. Mounting accessories allow the lamp to be attached to any kind of helmet.



TACTIKKA® +

Compact headlamp with mixed beam for proximity and distance vision. White lighting, or red to ensure stealth. 350 lumens

Designed for the workshop, small maintenance jobs, or concerts and shows, the TACTIKKA + headlamp provides 350-lumen brightness and a mixed beam, for comfortable proximity lighting and rapid movement. It also has red lighting to ensure stealth. TACTIKKA + comes with 3 standard batteries and is also compatible with the CORE rechargeable battery, thanks to its HYBRID CONCEPT design. Mounting accessories allow the lamp to be attached to any kind of helmet.



TACTIKKA®

Compact headlamp with flood beam for proximity lighting. White lighting, or red to ensure stealth. 300 lumens

Designed for the workshop, small maintenance jobs, or concerts and shows, the TACTIKKA headlamp provides 300-lumen brightness and a flood beam for comfortable proximity lighting. It also has red lighting to ensure stealth. TACTIKKA comes with 3 standard batteries and is also compatible with the CORE rechargeable battery, thanks to its HYBRID CONCEPT design. Mounting accessories allow the lamp to be attached to any kind of helmet.



TACTIKKA® ADAPT

TACTIKKA headlamp without headband and with mounts for use on any type of helmet. 300 lumens

TACTIKKA ADAPT is a ready-to-go lighting solution for use on any type of helmet. It consists of a TACTIKKA headlamp without a headband, a FIXATION TACTIKKA clip mount, and a KIT ADAPT adhesive mount.



Ultra-compact headlamps

Ultra-compact backup headlamp





30 lm
MAX
BRIGHTNESS



7 m
MAX
DISTANCE



15 h
MAX
BURN TIME

e+LITE®
Ultra-compact emergency headlamp. 30 lumens

Ultra-lightweight and highly compact, the e+LITE emergency headlamp is the one to always have with you. Thanks to its carry case, it is always ready to use and can be stored with its batteries for ten years in a backpack, a vest, or an emergency kit, or used as a back-up headlamp. Its white or red, 30-lumen fixed lighting or strobe lighting helps you to be seen. The whistle integrated in the elastic headband allows the user to signal an emergency. Weighing only 26 grams, e+LITE is an ideal emergency headlamp.



Its white or red, continuous or strobe lighting allows you to be seen and to signal an emergency.

Accessories



CORE

Rechargeable battery compatible with Petzl HYBRID headlamps

High-capacity 1250 mAh Lithium-Ion rechargeable battery for Petzl headlamps featuring the HYBRID CONCEPT design: TACTIKKA CORE, TACTIKKA, TACTIKKA + and TACTIKKA +RGB. It guarantees excellent lighting performance, even at low temperatures. It recharges directly with the integrated USB port. The CORE rechargeable battery offers an economical solution as the main power supply, or as a back-up battery.



FIXATION TACTIKKA®

Kit for mounting a TACTIKKA, TACTIKKA +, TACTIKKA +RGB or TACTIKKA CORE type headlamp on a STRATO or VERTEX helmet

FIXATION TACTIKKA is a kit that allows the user to mount or unmount a TACTIKKA, TACTIKKA +, TACTIKKA +RGB and TACTIKKA CORE headlamp on a helmet anytime, while retaining the ability to tilt the lamp. The system is especially resistant to impacts and moisture.



KIT ADAPT

Kit for mounting a TACTIKKA type headlamp onto a helmet

The KIT ADAPT allows the user to mount or unmount a TACTIKKA headlamp on a helmet anytime, while retaining the ability to tilt the lamp.



SHELL L

Carrying case for ultra-compact headlamps

The SHELL L case is for transport and protection of TACTIKKA, TACTIKKA +, TACTIKKA +RGB and TACTIKKA CORE headlamps in any situation. The headlamp is thus always readily accessible on the waistbelt.

Accessories		Weight			Weight
ACCU SWIFT RL PRO	E810BA00	50 g	CORE	E99ACA	23 g
POCHE PIXA & SWIFT RL PRO	E78001	44 g	FIXATION TACTIKKA	E093CA00	12 g
PIXADAPT	E78005	20 g	KIT ADAPT	E93001	30 g
RUBBER	E78002	-	SHELL L	E93990	41 g

						ANSI / PLATO FL 1					
		STANDARD LIGHTING	REACTIVE LIGHTING®	Lighting color	Lighting mode	MAX BRIGHTNESS	MAX DISTANCE	MAX BURN TIME	WEIGHT		
<p>SWIFT RL PRO</p> <p>E810AA00</p>	CE	●	-	white	Close-range work	10 lm	12 m	100 h	123 g		
					Proximity	200 lm	55 m	5 h			
					Movement	550 lm	110 m	2 h			
					Distance vision	250 lm	95 m	4 h			
				red	-	Visible at 700 m for 30 h					
				white	Close-range work	100 lm	35 m	10 - 50 h			
					Proximity	300 lm	55 m	5 - 40 h			
					Movement	900 lm	150 m	2 - 30 h			
Distance vision	550 lm	150 m	4 - 50 h								
<p>TACTIKKA CORE</p> <p>E099HA00</p>	CE	●	-	white	Proximity	6 lm	8 m	130 h	77 g		
					Movement	100 lm	45 m	8 h			
					Distance vision	450 lm	90 m	2 h			
				red	Proximity	2 lm	5 m	60 h			
					Strobe	Visible at 700 m for 400 h					
				white	Reserve lighting	5 lm for 3 h					
<p>TACTIKKA +RGB</p> <p>E089FA00 (black) E089FA01 (camouflage) E089FA02 (desert)</p>	CE	●	-	white	Proximity	6 lm	10 m	160 h	85 g		
					Movement	100 lm	45 m	30 h			
					Distance vision	350 lm	90 m	60 h			
				red green blue	Proximity	2 lm	5 m	60 h			
					Strobe	Visible at 700 m for 400 h					
				<p>TACTIKKA +</p> <p>E089EA00 (black) E089EA01 (camouflage) E089EA02 (desert)</p>	CE	●	-	white			Proximity
Movement	100 lm	45 m	30 h								
Distance vision	350 lm	90 m	60 h								
red	Proximity	2 lm	5 m					60 h			
	Strobe	Visible at 700 m for 400 h									
<p>TACTIKKA</p> <p>E093HA00 (black) E093HA01 (camouflage) E093HA02 (desert)</p>	CE	●	-					white	Proximity	6 lm	10 m
				Movement	100 lm	40 m	30 h				
				Distance vision	300 lm	65 m	40 h				
				red	Proximity	2 lm	5 m	60 h			
					Strobe	Visible at 700 m for 400 h					
				<p>TACTIKKA ADAPT</p> <p>E094AA00 (black)</p>	CE	●	-	white	Proximity	13 lm	6 m
Movement	30 lm	7 m	3 h								
red	Strobe	Visible at 100 m for 95 h									
	Strobe	Visible at 100 m for 70 h									



Product index

Product	Reference	Page
A		
ABSORBICA	L010AA00	88
ABSORBICA-I	L011AA00 / L013AA01	87
ABSORBICA-I VARIO	L016AA00	87
ABSORBICA-Y	L012AA00 / L014AA01	87
ABSORBICA-Y FALL ARREST KIT <small>NEW 2021</small>	K095AC00/01	154
ABSORBICA-Y MGO	L012BA/CA / L014BA/CA	24/44/87
ABSORBICA-Y TIE-BACK	L015AA00 / L015BA00	87
ACCU 2	E80002	176
ACCU 2 DUO Z1	E80001	176
ACCU SWIFT RL PRO	E810BA00	186
AIRLINE	R02Y 060/300	147
Am'D	M34A	101
Am'D PIN-LOCK	M34A PL	103
AMPOULE BAT'INOX	G103AA00	130
AMPOULE COLLINOX	G101AA00	130
ANNEAU	C40	132
ASAP	B070AA00	95
ASAP'AXIS 11mm	R074DA00/01/02/03/04/05	96
ASAP FALL ARREST KIT	K093AB00/01/02/03	153
ASAP VERTICAL LIFELINE	K091AB00/01	152
ASAP LOCK	B071BA00	95
ASAP LOCK FALL ARREST KIT	K094AA00/01/02/03	153
ASAP LOCK VERTICAL LIFELINE	K092AA00/01	152
ASAP'SORBBER	L071AA00 / L071AA01	96
ASAP'SORBBER AXESS	L071CB00	96
ASCENSION	B17ALA/LN/RA/RN	118
ASCENTREE	B19AAA	119
ASTRO BOD FAST	C083AA / C083BA	58
ASTRO SIT FAST	C085AA00/01/02	58
AVAO BOD	C071AA/CA	56
AVAO BOD FAST	C071BA/DA	
AVAO SIT	C079AA	56
AVAO SIT FAST	C079BA	
AXIS 11 mm	R074AA / R074BA	96/139
B		
BALACLAVA	A016CA00/01	78
BASIC	B18BAA	120
BAT'INOX	G102AA00	130
BEANIE	A016BA00/01	78
BERMUDE	C80	64
Bm'D	M032AA00/01	102
BOLTBAG	C11 A	65
BUCKET	S41AY / S41AR	147
C		
CAPTIV	M093AA00	104
CAPTIV ADJUST	M095AA00	104
CAPTIVO	M094AA00	104
CARITOOOL	P042AA00/01	65
CHEST'AIR	C98A	63
CHICANE	D022CA00	113
COEUR	P36AA / P36AS / P36AH	130
COEUR BOLT	P36BA / P36BS / P36BH	130
COEUR PULSE	P37S 12	130
COLLINOX	G100AA00	130
CONNEXION FIXE	G010AA00/01/02	132
CONNEXION VARIO	G011AA00/01	132
CONTROL 12.5 mm	R080AA	139
CORDEX	K52	148

Product	Reference	Page
CORDEX PLUS	K53	148
CORE	E99ACA	190
CRAB 6	64160	148
CROLL S / L	B16BAA / B016AA00	119
D		
DELTA	P11	104
DEMI ROND	P18	104
DUFFEL 65 <small>NEW 2021</small>	S045AA00	146
DUFFEL 85 <small>NEW 2021</small>	S045AA01	146
DUO S	E80CHR	175
DUO RL <small>NEW 2021</small>	E103AA00	172
DUO Z1	E80BHR	175
DUO Z1 (x5)	E80DHR	
DUO Z2	E80AHB	175
E		
e+LITE	E02 P4	190
EASHOOK OPEN	M043AA00/01	90/103
ECLIPSE	S03Y	147
EJECT <small>NEW 2021</small>	G001AA00	134
EXO AP HOOK	D031DA00	34/114
F		
FALCON	C038AA00/01/02/03/04	63
FALCON ASCENT	C038BA00/01	63
FALCON MOUNTAIN	C038CA00/01	63
FALL ARREST AND WORK POSITIONING KIT	K096AB00/01	154
FIXATION TACTIKKA	E093CA00	190
FIXE	P05W / P05WN	126
FLOW 11.6 mm	R079AA	139
FOOTAPE	C47A	118
FOOTCORD	C48A	118
FREINO Z	M042BA00	103
G		
GEMINI	P66A	125
GO	P15	104
GRILLON	L052AA	85/133
GRILLON HOOK	L052BA / L052CA	85
GRILLON MGO	L052DA00/01	85
GRILLON PLUS	L052EA00/01	85
H		
HUIT	D02	114
I		
I'D EVAC	D020CA00/01	109
I'D L	D020BA00/01	109
I'D S	D020AA00/01	109
IGUANE	L001AA00/01	90
J		
JAG	P45	126
JAG RESCUE KIT	K090AA00/01/02	36/156
JAG SYSTEM	P044AA00/01/02	126
JAG TRAXION	P54	126
JANE-I <small>NEW 2021</small>	L050BA00/01/02	88
JANE-Y <small>NEW 2021</small>	L051AA00/01/02	88
JET	S02Y 250/300/350	147
K		
KIT ADAPT	E93001	190
KNEE ASCENT CLIP	D022EA00	119
KNEE ASCENT LOOP	D022DA00	119
KOOTENAY	P67	126

Product	Reference	Page
L		
LEZARD	L01	90
LIFT	L54	65
LINER	A016AA00/01	78
LOOPING	C25	118

M		
MAESTRO S / L	D024AA00 / D024BA00	111
MAMBO 10.1 mm <small>NEW 2021</small>	R32AC	140
MGO OPEN	MG00 60 / M080XAA00	90 / 103
MICRO SWIVEL	P58 XSO	131
MICRO TRAXION	P53	125
MICROFLIP	L33 025/040/055	89
MICROGRAB	B53A	89
MINDER	P60A	125
MINI	P59A	125
MOBILE	P03A	126

N		
NEST	S061AA00	64
NEWTON <small>NEW 2021</small>	C073AA / BA	50/52
NEWTON EASYFIT <small>NEW 2021</small>	C073CA / DA	50/52
NEWTON FAST <small>NEW 2021</small>	C073EA / FA	50/52

O		
OK	M33A	101
OMNI	M37	103
OXAN	M72A	102

P		
PANTIN	B02CLA / B02CRA	119
PARALLEL 10.5 mm	R077AA	139
PARTNER	P52A	124
PAW <small>NEW 2021</small>	G063AA / BA / CA	131
PERSONNEL 15L	S44Y 015	146
PITAGOR	C80 BR	64
PIXA 1	E78AHB 2/2UL	181
PIXA 2	E78BHB 2/2UL	181
PIXA 3	E78CHB 2/2UL	181
PIXA 3R	E78CHR 2	181
PIXADAPT	E78005	182/186
PIXA Z1	E78DHB 2	181
POCHE PIXA & SWIFT RL PRO	E78001	182/186
PODIUM	S071AA00	59
PORTAGE 30L	S43Y 030	146
PORTO	C33	65
PRO ADAPT	E80004	176
PRO TRAXION	P51A	125
PROGRESS ADJUST-I	L044BA00/ 01/02/ 03	88/89/133
PROGRESS ADJUST-Y	L044AA00	88/118
PROTEC	C45 N	141
PUR'ANNEAU	G006AA00/01/02	132

R		
RACK	D11	114
RAY 11 mm <small>NEW 2021</small>	R100AA / R100BA	96 / 140
RESCUCENDER	B50A	120
RESCUE	P50A / P50AN	124
RIG	D021AA00/01	109
RING	C04620 / C04630	131
RING OPEN	P28	65/104/131
ROLL MODULE	P49	141
ROLLCAB	P47	126
ROLLCLIP A	P74 TL / P74	125
ROLLCLIP Z	P75 TL / P75 SL	125

Product	Reference	Page
RUBBER	E78002	182/186

S		
SECUR	C74A	119
SEGMENT 8 mm	R076AA00/03/06	140
SEQUOIA	C069AA00/01/02	60
SEQUOIA SRT	C069BA00/01/02	60
SET CATERPILLAR	P68	141
SHELL L	E93990	190
Sm'D	M39A	102
SPATHA	S92AN	148
SPIKY PLUS	79510 / 79520 / 79530	148
SPIN L1 <small>NEW 2021</small>	P001BA00 / P001BA01	124
SPIN L1D <small>NEW 2021</small>	P001AA00	124
SPIN L2 <small>NEW 2021</small>	P001CA00 / P001CA01	124
ST'ANNEAU	C07 24/60/120	132
STEF	S059AA00 / S059BA00	64
STRATO	A020AA00/01/02/03	75
STRATO HI-VIZ	A020CA00/01	75
STRATO VENT	A020BA00/01/02/03	75
STRATO VENT HI-VIZ	A020DA00/01	14 / 75
STRING	M090AA00/01	104
STUART	M096AA00	104
SWIFT RL PRO	E810AA00	186
SWIVEL S / L	P58 S / P58 L	131
SWIVEL OPEN	P58 SO	131

T		
TACTIKKA	E093HA00/01/02	189
TACTIKKA ADAPT	E094AA00	189
TACTIKKA +	E089EA00/01/02	189
TACTIKKA +RGB	E089FA00/01/02	189
TACTIKKA CORE	E099HA00	189
TANDEM / TANDEM SPEED	P21 / P21 SPE	126
TANGA	M92000	104
TIBLOC	B01BN	120
TOOLBAG	S047AA00 / S47Y S / S47Y L	65
TOP	C081AA00 / 01	56
TOP CROLL S / L	C081BA00 / C081CA00	58
TRANSPORT 45L	S42Y 045	147
TREESBEE	C04110	134
TREESBEE SCREWLINK	C04110 M	134
TWIN	P65A	125

V		
VECTOR 12.5 mm	R078AA	139
VERTEX	A010AA00/01/02/03/04/05/06	75
VERTEX HI-VIZ	A010DA00/01	75
VERTEX VENT	A010CA00/01/02/03/04/05/06	75
VERTEX VENT HI-VIZ	A010EA00/01	75
VERTIGO TWIST-LOCK	M40A RLA	90/103
VIZEN	A014AA00	76
VIZEN MESH	A021AA00	76
VIZIR	A015AA00	76
VIZIR SHADOW	A015BA00	76
VOLT / VOLT WIND	C72AA/CA / C72BA/DA	24/54
VULCAN	M073	102

W		
WILLIAM	M36A	101
WIRE STROP <small>NEW 2021</small>	G200AA00/01/02/03/04	132

Z		
ZIGZAG / ZIGZAG PLUS	D022AA00 / D022BA00	113
ZILLON	L22A 025/040/055	89



Climbing

Whether climbing at a crag or on an indoor wall, Petzl is constantly imagining new solutions for dedicated climbers, or for those simply seeking a moment to recreate and be social.



Caving

Petzl's roots are in subterranean exploration! For over 50 years, since the development of our very first headlamps, rope clamps and descenders, we have shared a profound connection with explorers of the deep.



Ice climbing

Ice climbing is very technical and requires highly specialized equipment. Gullies, couloirs, icefalls: climbing these ephemeral formations always brings an extra bit of adventure.

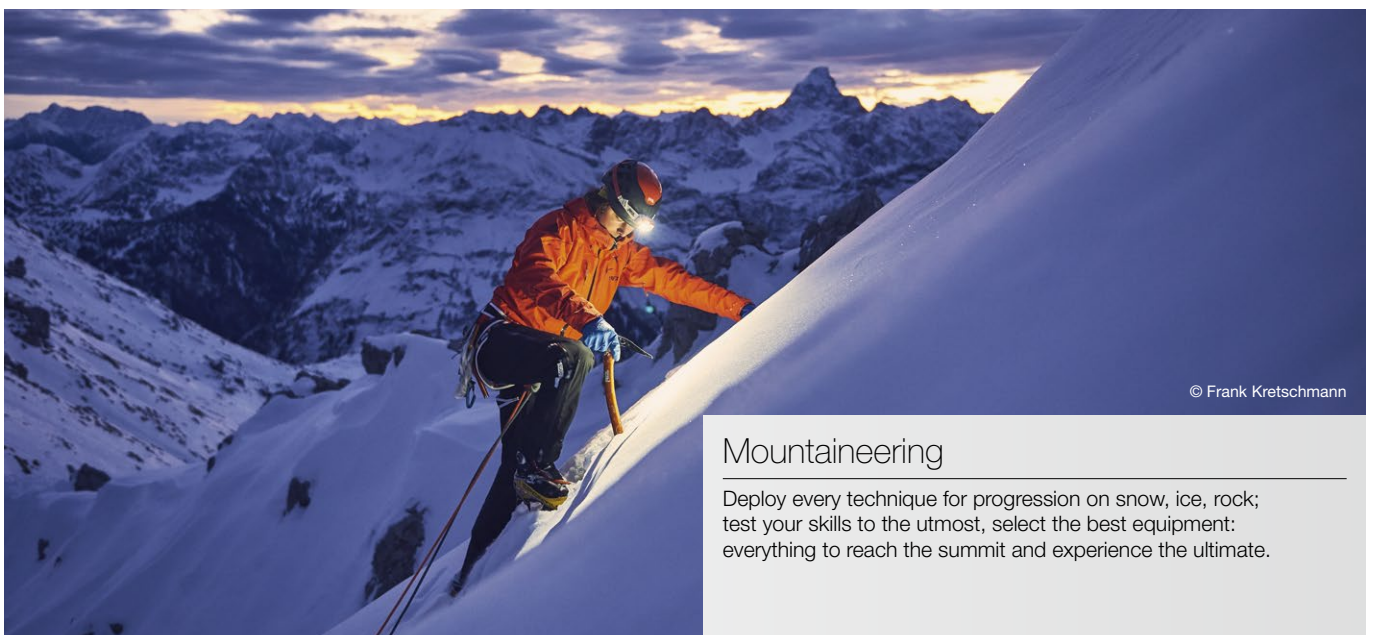

Mountaineering

Deploy every technique for progression on snow, ice, rock; test your skills to the utmost, select the best equipment: everything to reach the summit and experience the ultimate.



Canyoning

A combination of hiking, climbing and swimming in whitewater, canyoning has become a major outdoor activity in recent years, even outside the summer season.



Via ferrata

Via ferrata is the most affordable way to discover the vertical environment, via a route made up of cables, ladders and steps on a rock wall. A wonderful introduction to more technical pursuits...

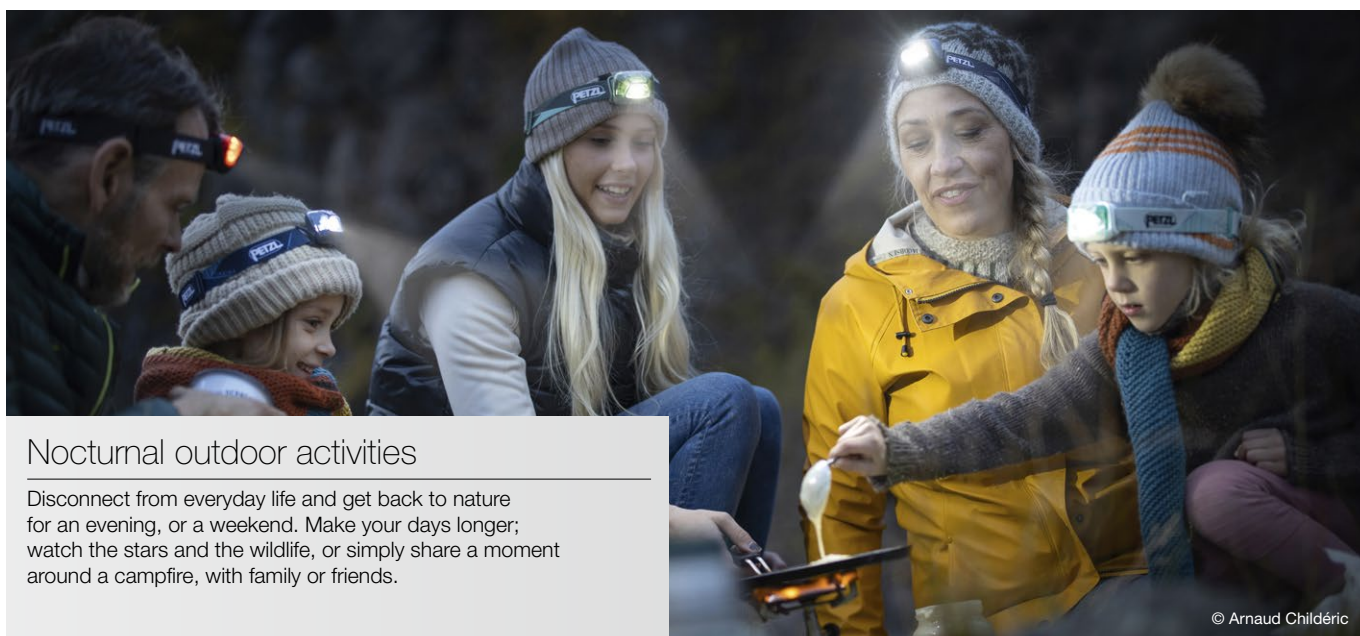

Nocturnal outdoor activities

Disconnect from everyday life and get back to nature for an evening, or a weekend. Make your days longer; watch the stars and the wildlife, or simply share a moment around a campfire, with family or friends.



Night running

Get out of the house, tread the city streets or the trails; run for a different perspective on your daily life, to get closer to nature, or to train.

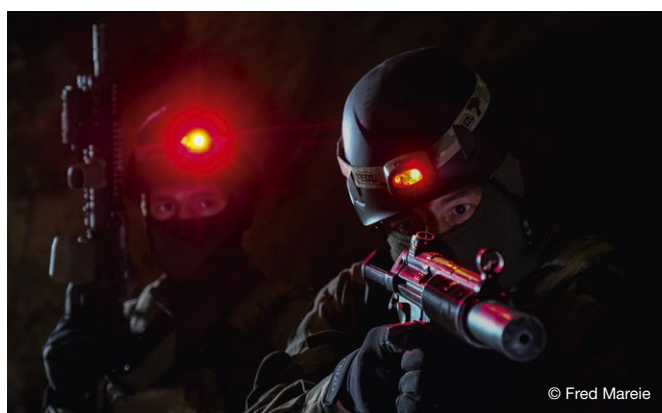

Tactical, special forces

Tactical operations in a hostile environment require maximum safety in every situation, so being able to count on the quality and performance of the equipment is essential.



Exploring new horizons

Reaching a summit or progressing in the vertical world gives rise to enduring passions that help women and men grow, thrive and dream. For over 15 years, the Petzl Foundation's mission has been to support and initiate public interest projects through its activities in mountainous and vertical domains, projects that help bring balance to humankind's place in our natural, cultural, and economic environments.



© Serge-Caillault

Encouraging learning and risk management to avoid accidents.



© Gonzalo Ignazi

Promoting the preservation of hard-to-access ecosystems.



© Sarah Del Ben, Fondation UGA

Contributing to enhanced understanding of best practices in the vertical world.



© Philippe Psaila

Fauna inventory in the Guianese forest canopy

The CAFOTROP association organizes scientific expeditions around the world to study the biodiversity of forest canopies. It is developing tree climbing techniques derived from the tree care industry to make the canopy accessible to scientists. The Petzl Foundation has helped finance one of its field missions in the Guianese forest canopy. Accompanied by tree climbers, scientists from the National Museum of Natural History set up photo traps in fruit trees, southeast of Cayenne, along the edge of National Highway 2. The first results revealed an unexpected visitation of the canopy by fruit-eating vertebrates, who contribute to seed dispersal, thus ensuring forest regeneration.

Supported partner: CAFOTROP

Location: French Guiana

Financial support: 2,500 €

Photo: Installing an automatic camera in the crown of a yayamadu (virola) tree on the side of National Highway 2 in French Guiana, between Régina and Saint-Georges-de-l'Oyapock.

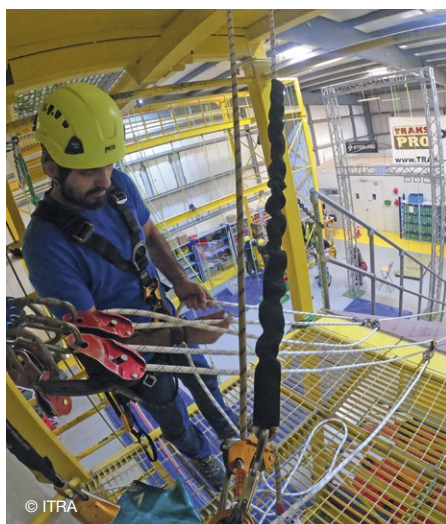

© ITRA

Technical rescue gets organized

Created in 2018 in the United States by technical rescue experts, the International Technical Rescue Association (ITRA) aims to promote best practices and the dissemination of rescue training standards. Through its actions, it works to ensure better recognition of technical rescue professionals. ITRA trains its own instructors, then provides technical rescue training in environments as diverse as whitewater, earthquake-damaged buildings, verticality or confined spaces. The nonprofit organization receives broad support from companies specializing in the rescue sector, as well as a global network of rescue experts. It operates mainly in North America, the United Kingdom and New Zealand.

Supported partner: International Technical Rescue Association (ITRA)

Location: United States

Financial support: 4,500 €

See all Petzl Foundation projects

www.petzl.com

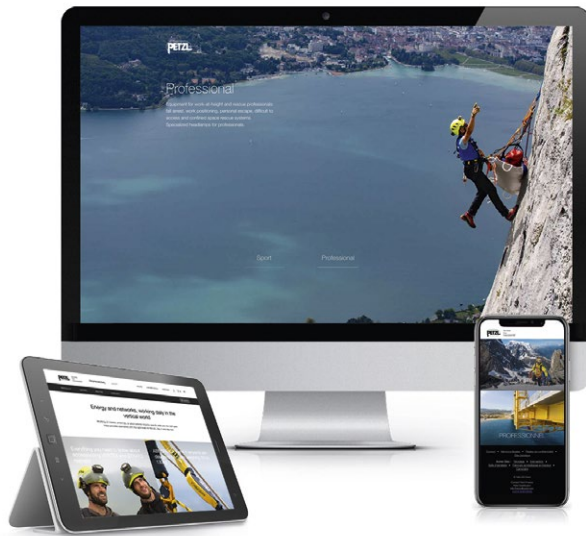

The site for professionals working at height and in dark environments.

- Discover Petzl's solutions for verticality and lighting
- Check out tips and technical information on best practices for using Petzl products
- Find all the Petzl news and reports on various trades: videos, news, portraits, events...

Pages to explore

Beyond our product offerings, Petzl offers a wide range of technical information: Instructions for Use, technical advice, PPE inspection records... Discover all the content pages on our website. Whether you are novice or expert in your field, Petzl shares its technical expertise to help you work more safely and efficiently.

- On our product pages, you will find:
- Instructions for Use: they are the base of our technical information and provide the essentials for using your products. Remember to read them before using your products
 - Technical advice, "by Petzl". They contain information complementary to the Instructions for Use: test results, feedback, technical videos... Documents with all you need to know about your products!
 - Records and procedures for PPE inspection: use them to inspect your PPE

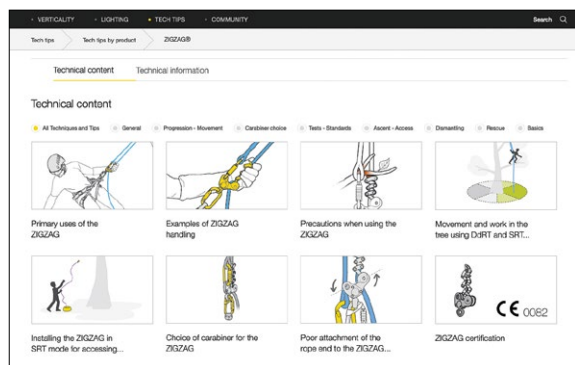

Also find us at:



© Petzl 2020



Petzl headquarters: PETZL INTERNATIONAL. Z.I. Crolles, 38920 CROLLES, FRANCE

Graphic design: Pierre Bena design - www.pierrebenadesign.com
Product photos (non-contractual photos): © Petzl
 Kalice - www.kalice.fr
 Aurélie Jeannette Photographe - www.aureliejeannette.com
 Yannick Siegel
Digital publishing: Fluidbook.com

The activities depicted are inherently dangerous. All users must be trained and competent in the use of the equipment for these activities.

Access the inaccessible[®]



Subscribe to the newsletter
and stay connected to our news

Find a dealer

Cover

Rock fall protection works near Marseille, France
© 2020 Petzl Distribution - Vuedici.org - Profil - DDTM 13

Ancient mine inspection and measurements, France
© 2020 Petzl Distribution - Lafouche