



generating confidence

maxlogic & mavigard  
fire and gas detection systems



**M I S S I O N**  
**M A N U F A C T U R I N G**  
**I N N O V A T I O N**  
**C O N F I D E N C E**  
**D E V E L O P M E N T**  
**Q U A L I T Y**



**M**avili Elektronik A.S. has been **GENERATING CONFIDENCE** since 1987 with Mavili, Mavigard, Maxlogic, Maxlogic & Mavigard brand names.

The company which is improving continuously its service network infrastructure; has offices in Ankara, Izmir, Antalya, Diyarbakir, Samsun, Bursa, Istanbul (European side), Russian central office in Moscow and authorized dealer in Istanbul Perpa Trade Center.

Mavili products are exported to more than 70 countries in different regions of the world, in addition we always provide pre-sales and after sales support for our **CUSTOMERS AND DISTRIBUTORS.**

Mavili continues manufacturing high quality products and maintaining services with its dynamic staff of more than 250 people, composed of technicians and engineers, working hard for **CUSTOMER SATISFACTION.**

**mavili**

## Our Mission

Being a “high technology” company which is respectful to society, environment, ethical values; which researches, learns and improves itself continuously; which realizes the market realities and gets the right decisions.

## Our Vision

Effective and professional global manufacturing of high technology products.



## Certificates and Licenses

- \* The **ISO 9001:2015** Quality Management System of Mavili Elektronik A.S has been audited and conformed by LPCB (Loss Prevention Certification Board) / ENGLAND.
- \* Our Fire Detection and Alarm System products were **EN 54** and **CPR** certified by **LPCB** and **Dedal**, thus approving our quality by internationally accredited institutions.
- \* **TS EN ISO / IEC 27001: 2017** Information Security Management System that we are implementing, inspected by by VeriCert Belgelendirme ve Gözetim Hizmetleri Ltd. Şti." and its compliance has been documented with **TS EN ISO / IEC 27001: 2017** certificate.
- \* TSE / TURKEY (Turkish Standards Institute) entitled us to get **TS EN 54** certificates for Intelligent Addressable and Conventional Fire Alarm System products, **TS EN 50194** certificate for our gas detectors.
- \* OUR SERVICES are awarded with **TS 12849** for Place of Service and Sales Service Qualification certificate.
- \* Our marine series products have **TURK LLOYD** (SOLAS 74 and FSS), **WHEELMARK** which is an indication of **MED** conformity, and "**Russian Maritime Register of Shipping**" type approval certificate, a member of IACS (International Association of Classification Societies Ltd.).
- \* We were entitled to receive the **Zero Waste** Certificate for our Gebze factory.
- \* Our products have Licenses for Usage from Ministries of many countries.



Company Presentation  
Certificates and Licenses

3



References



Intelligent Addressable  
Fire Detection and Alarm Systems



Beam Type Smoke Detectors



Conventional Fire Detection  
and Alarm Systems



GD2R Series Gas Detector,  
Conventional Gas Alarm  
Control Panel



Gas Alarm Control Panel,  
4 Channel



Conventional Fire  
Extinguishing Control Panel



LLOYD Certified Marine Type  
Fire Alarm Control System

# References

Porta Batumi / Georgia



Claremont Group  
Apartments  
Erbil / Iraq



Somali Mogadishu  
Airport



Wagagen Bank  
Headquarter  
Ethiopia



Novotel Next  
Almaty / Kazakhstan



Azadi Tower / Iran



Caves Beach  
Resort / Egypt



Primorskiy Hotel  
Sochi / Russia





More than **70.000** sites around the world are protected By **Mavigard & Maxlogic** fire and gas alarm systems.







## Smart Solutions for Buildings...

# Intelligent Addressable Fire Detection And Fire Systems

MAXLOGIC series fire alarm control panels, offering high performance by the VIP communication protocol, provide solutions to projects.

- ▶ Protection from electromagnetic interference
- ▶ 'Soft' addressable by use of address programmer
- ▶ User friendly
- ▶ Programmable remote control inputs
- ▶ Addressable detectors, call points, loop-powered addressable sounder interface modules (monitor and control modules) and analogue addressable gas detectors can be programmed, in order to operate in cause-effect scenarios and the fire automation can be built in this manner.
- ▶ LCD with 260x64 adjustable blue backlight indicates fire alarm, fault and other information in details
- ▶ Day and night mode, pre alarm, contamination warning
- ▶ Top priority of fire alarm indication, different buttons for fire and other events, categorical classification of events
- ▶ All outputs have silenceable/non-silenceable and latching/non-latching and options
- ▶ Supervised sounder, fire relay, alarm relay and fault relay outputs
- ▶ Possibility to select event type for all input/output devices
- ▶ Panel and input-outputs can be programmed with the loop manager software
- ▶ Panels can be monitored and controlled remotely via Sprvsr+ for short distance with cable, for long distance as wireless
- ▶ Four language options for menu, software and silkscreen: Turkish, English, Russian and French
- ▶ Communication interrupt for fast fire alarm detection in 1.5 seconds



In **cause-effect scenario**, below functions etc. are done completely by the system

- ▶ Stopping ventilation panels in related zones,
- ▶ Operating emergency announce system,
- ▶ Operating smoke evacuation system,
- ▶ Commanding fire / smoke dampers,
- ▶ Closing protective doors that between various zones,
- ▶ Operating pressurization fans that located in main ladder hall and fire ladder,
- ▶ Routing elevator to related floors,
- ▶ Activation of emergency lighting systems

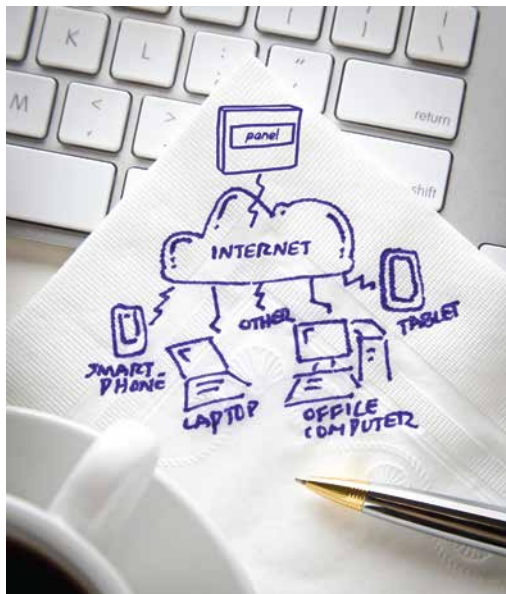

- ▶ Activation of gas cutting system,
- ▶ Activation of extinguishing systems,
- ▶ Sending voice mail, SMS or e-mail, alarm and fault signals to the nearest fire fighter panel and other authorized units
- ▶ Graphical monitoring and remote control with RS-232/485, TCP/IP, GPRS protocols

Intelligent addressable detectors, call points and control modules that create the system to be programmable according to cause/effect logics and they are able to respond to comprehensive fire scenarios. According to cause/effect logics between panels that operate as network; for each panel at up to 1000, within the network up to **64.000** scenarios can be defined.

Maxlogic series intelligent analogue addressable fire alarm panels may operate as network via **fiber optic** cable infrastructure.

Compatible with **Modbus** or **BACnet** protocols that provide direct information exchange with other building control and automation systems.

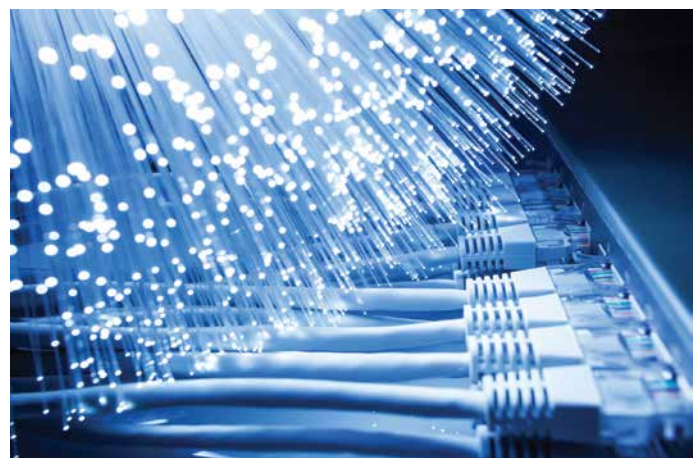



8

## Smart Solutions for Buildings...

Four different methods are used for remote access of fire detection and alarm system:

- For short distance with cable, RS-232
- For long distance with cable, RS-485 communication module
- Via LAN, WAN and internet for remote access **TCP/IP** communication module
- Using GPRS via internet, GPRS communication module is used for remote access



Up to 64 panels can be operated within network and thus occurred fire alarms, fault etc. in any panels can be monitored and can be controlled (alarm silence, buzzer silence, reset etc.) from each panel.

Network communication between fire panels is provided via **CAN** communication protocol that prevents loss of data.



Maxlogic intelligent analogue addressable fire detection system is graphically monitored and managed from 16 different monitoring centers.

With **Sprvsr+** software fire detection system can be monitored and controlled via Android and IOS telephones.



In case of fire or an emergency, a competent person's live **announcements** are provided through public announcement module integrated in intelligent fire alarm system.

The pre-recorded message of voice evacuation of the available announcement system found in the building in which fire detection system will be installed are activated on fire scenario of the building.

In case of fire or emergency situation, safe and uninterrupted communication can be made between authorized people, security center, intelligent addressable fire panels and portable or fixed firefighter **telephones**.





Each fire alarm control panel; working as one or as network can be accessed and monitored from 16 different locations from the same or different communication modules.



To city information...



In case of fire and fault; geographical location where the event occurred, building and floor information, floor plans and device details can be monitored easily.



City details to address information...



Address details to building information...



Building details to floor plans and the devices in alarm are monitored.



The control and monitoring operations related fire detection system can be performed remotely via Sprvsr+.



**Device Information**  
 Network Address: 3  
 Panel Address: 1  
 Loop Address: 1  
 Device Address: 123  
 Zone: 4  
 Device Type: ML-9100.00  
 Device Description: Optical Smoke Detector  
 Location Information: Location Information 123  
 Its Map: 1st Floor

CLOSE





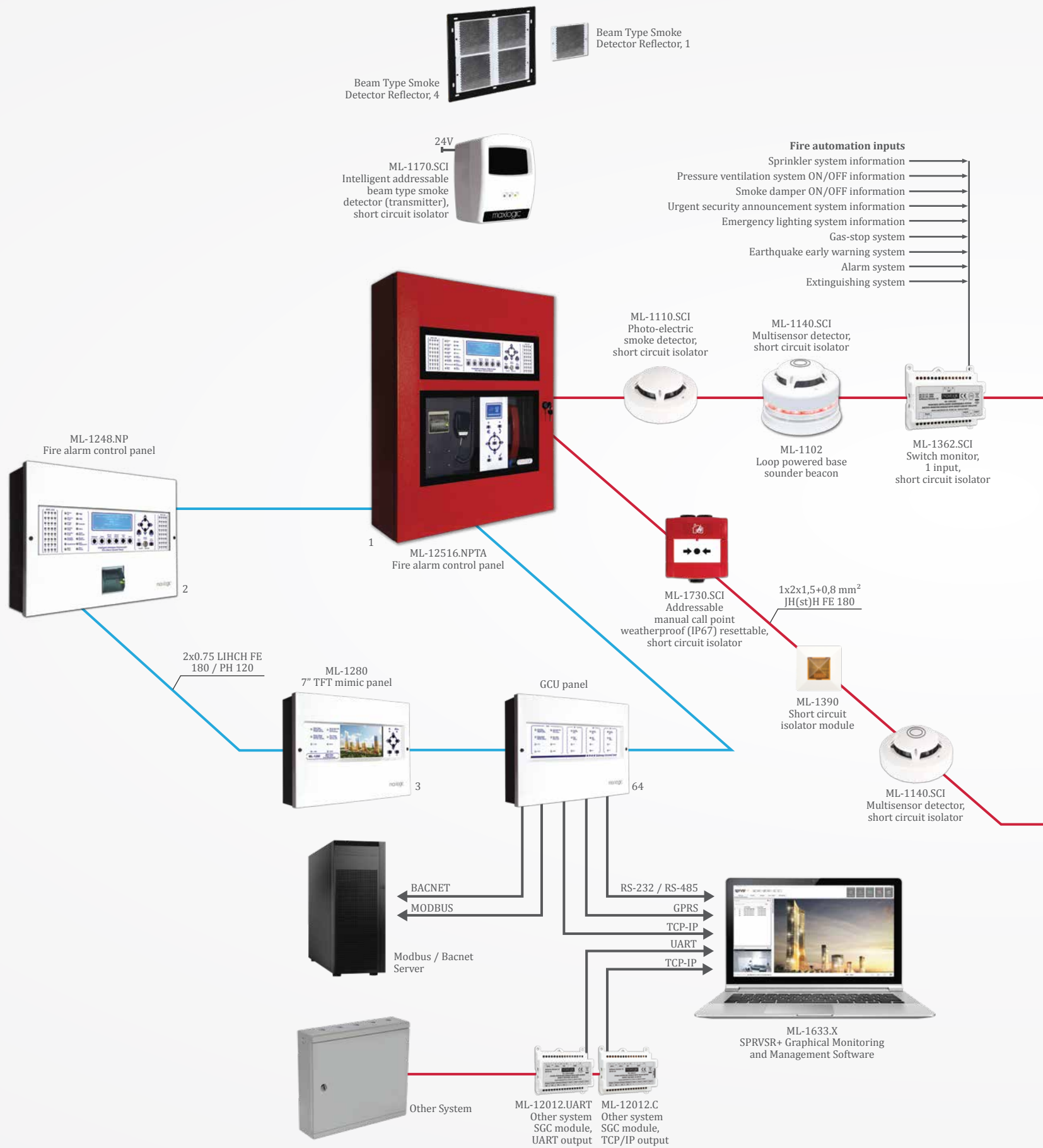

- ▶ Up to 64 panels and/or repeater panels can be assembled with CAN protocol into a network.
- ▶ By the help of this feature, Maxlogic & Mavigard system is used easily in big buildings, hospitals, universities etc. projects.
- ▶ Max. 130.048 devices can be used in Maxlogic Addressable Fire Detection System.



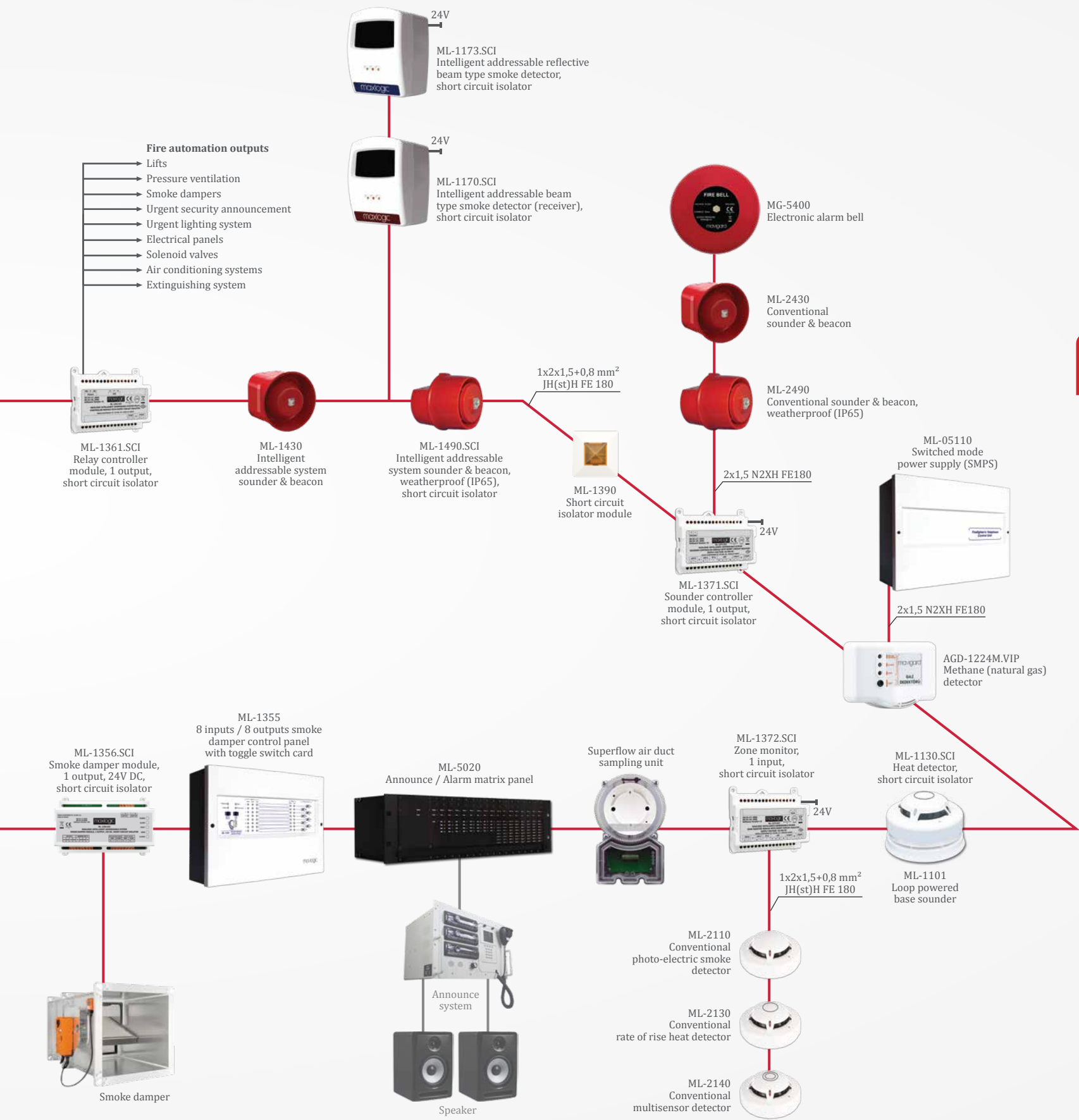

- ▀ Events can be monitored from any panel in Network.
- ▀ Controlling all other panels from any panel.
- ▀ Creating cause-effect scenarios between devices that is connected to panels in network.

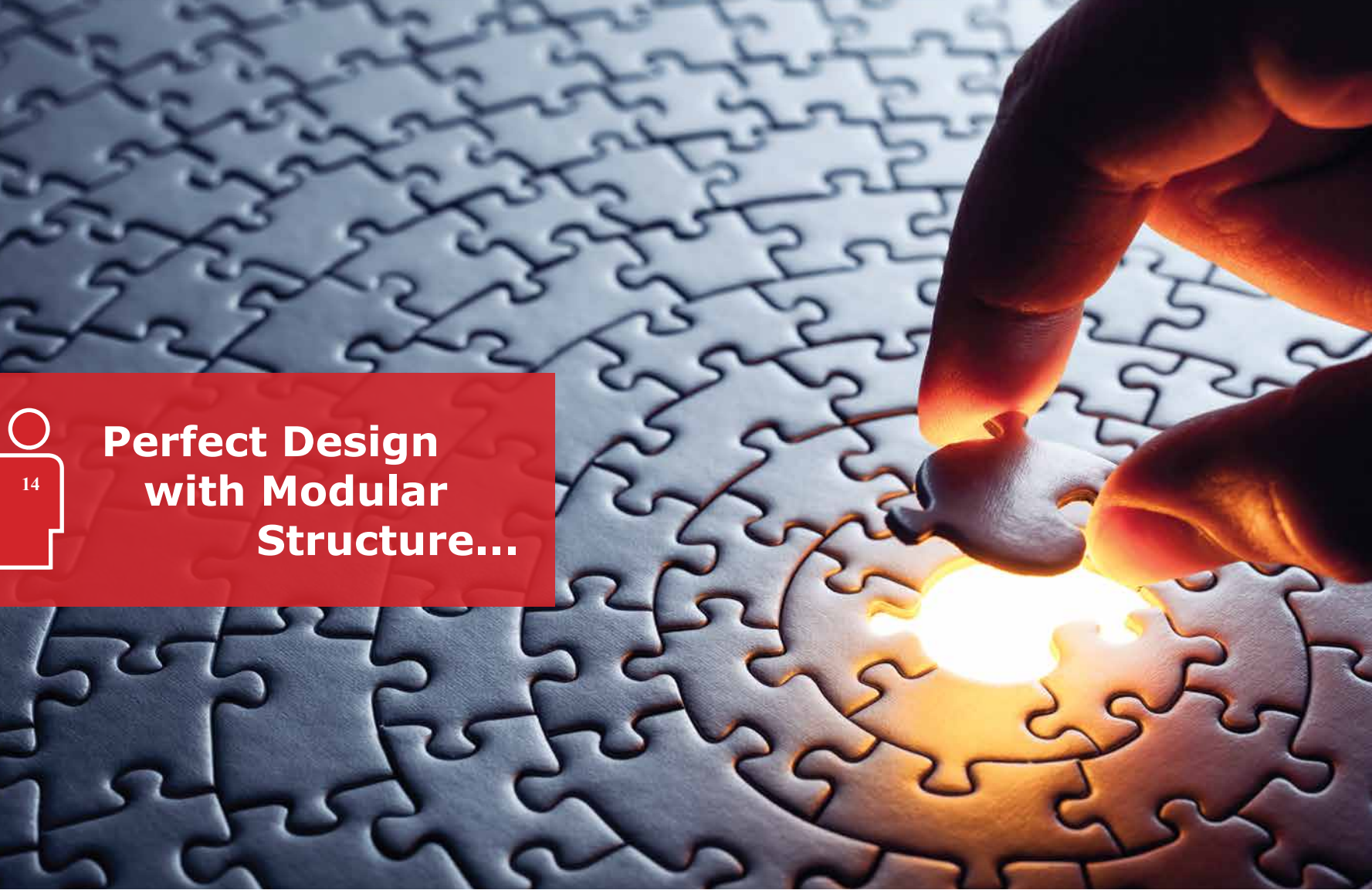

**Perfect Design  
with Modular  
Structure...**

# Intelligent Addressable Fire Alarm Panels



ML-12516  
Fire Alarm Control Panel

- Surface mount technology
- Protection from electromagnetic interference
- Real time clock

Maxlogic series fire alarm control panels which have aesthetic design and user friendly features, offering high performance by the VIP communication protocol.



ML-12516.NPTA  
Fire Alarm Control Panel  
Network, Printer, Telephone  
/Announce Control Unit

- ▶ Compatible with EN 54-2 and EN 54-4
- ▶ Expandable loops up to 16 loops, max. 2032 address capacity for each panel

#### Printer Module

Event logs can be printed instantaneously or collectively by the printer module. Since the printer is thermal type, running out of ink is no longer a problem.

#### Telephone Module

In case of fire or emergency events, communication can be provided between security center, firefighter's telephones and telephones on the other panels via firefighter's telephone control unit.

#### Announce Module

In case of fire and emergency events, Announce module can be integrated to all kinds of present announce systems (all brands and models) via alarm announce matrix panel, it provides to live announcement to determined areas via panel.

#### Telephone / Announce Control Unit

The use of telephone module and public announce module Over the panel is realized with the LCD designed control unit.

#### PANEL MODELS

Product code	Loop	Address	Product code	Loop	Address
ML-1250.N	0	0	ML-1259	9	1143
ML-1251	1	127	ML-12510	10	1270
ML-1252	2	254	ML-12511	11	1397
ML-1253	3	381	ML-12512	12	1524
ML-1254	4	508	ML-12513	13	1651
ML-1255	5	635	ML-12514	14	1778
ML-1256	6	762	ML-12515	15	1905
ML-1257	7	889	ML-12516	16	2032
ML-1258	8	1016			

#### PANEL MODELS

Product code	Loop	Address	Product code	Loop	Address
ML-1250.NPTA	0	0	ML-1259.NPTA	9	1143
ML-1251.NPTA	1	127	ML-12510.NPTA	10	1270
ML-1252.NPTA	2	254	ML-12511.NPTA	11	1397
ML-1253.NPTA	3	381	ML-12512.NPTA	12	1524
ML-1254.NPTA	4	508	ML-12513.NPTA	13	1651
ML-1255.NPTA	5	635	ML-12514.NPTA	14	1778
ML-1256.NPTA	6	762	ML-12515.NPTA	15	1905
ML-1257.NPTA	7	889	ML-12516.NPTA	16	2032
ML-1258.NPTA	8	1016			



## Simple and Functional...

# Intelligent Addressable Fire Alarm Control Panels

Maxlogic series fire alarm control panels which have aesthetic design and user friendly features, offering high performance by the VIP communication protocol.



ML-1248.P  
Fire Alarm Control Panel

- ▶ Compatible with EN 54-2 and EN 54-4
- ▶ Expandable up to 8 loops, max. 1016 addresses capacity for each panel.
- ▶ Event logs can be printed instantly or collectively by the printer module.





ML-1238  
Fire Alarm Control Panel

- ▶ Compatible with EN 54-2 and EN 54-4
- ▶ Expandable up to 8 loops, max 1016 address capacity of each panels
- ▶ Real time clock

- ▶ Surface mount technology
- ▶ The key is needed for entry to panel menu
- ▶ Protection from electromagnetic interference
- ▶ Supervised peripheral devices, extension cards (power supply, loop extensions, printer..)
- ▶ 4 programmable supervised remote control inputs
- ▶ Input/output modules can be connected to panel
- ▶ 1000 event log and programmable zones memory
- ▶ User friendly and aesthetic design and easy installation
- ▶ Advanced parametric arrangement options for input/output devices
- ▶ Top priority of fire alarm indication, different buttons for fire and other events, categorical classification due to events
- ▶ Communication interrupt for fast fire detection in 1.5 sec
- ▶ 1000 automation scenarios can be created for each panel
- ▶ Up to 64 panels and/or repeater panels can be assembled with CAN protocol
- ▶ Day and night mode, pre-alarm, contamination warning into a network

PANEL MODELS		
Product code	Loop	Address
ML-1230.N	0	0
ML-1231	1	127
ML-1232	2	254
ML-1233	3	381
ML-1234	4	508
ML-1235	5	635
ML-1236	6	762
ML-1237	7	889
ML-1238	8	1016

PANEL MODELS		
Product code	Loop	Address
ML-1240.N	0	0
ML-1241.P	1	127
ML-1242.P	2	254
ML-1243.P	3	381
ML-1244.P	4	508
ML-1245.P	5	635
ML-1246.P	6	762
ML-1247.P	7	889
ML-1248.P	8	1016

Service is in your authorization...



# ML-122X Series Maxlogic Intelligent Addressable Fire Alarm Control Panels

In ML-122X series intelligent addressable panel and system; detectors, manual call points, loop-powered sounders, intelligent addressable loop-powered base sounder/sounder beacon, zone control modules and gas detectors can be programmed to work in cause&effect scenarios and fire automation can be done.



- ▶ Complies with EN 54-2 and EN 54-4 standards
- ▶ Supervised peripheral devices
- ▶ Advanced parametric arrangement options for input/output devices
- ▶ Top priority of fire alarm indication, different buttons for fire and other events, categorical classification due to events
- ▶ 1000 event log and 64 programmable zones memory
- ▶ Expandable up to 2 loops and 254 address capacity with modular structure

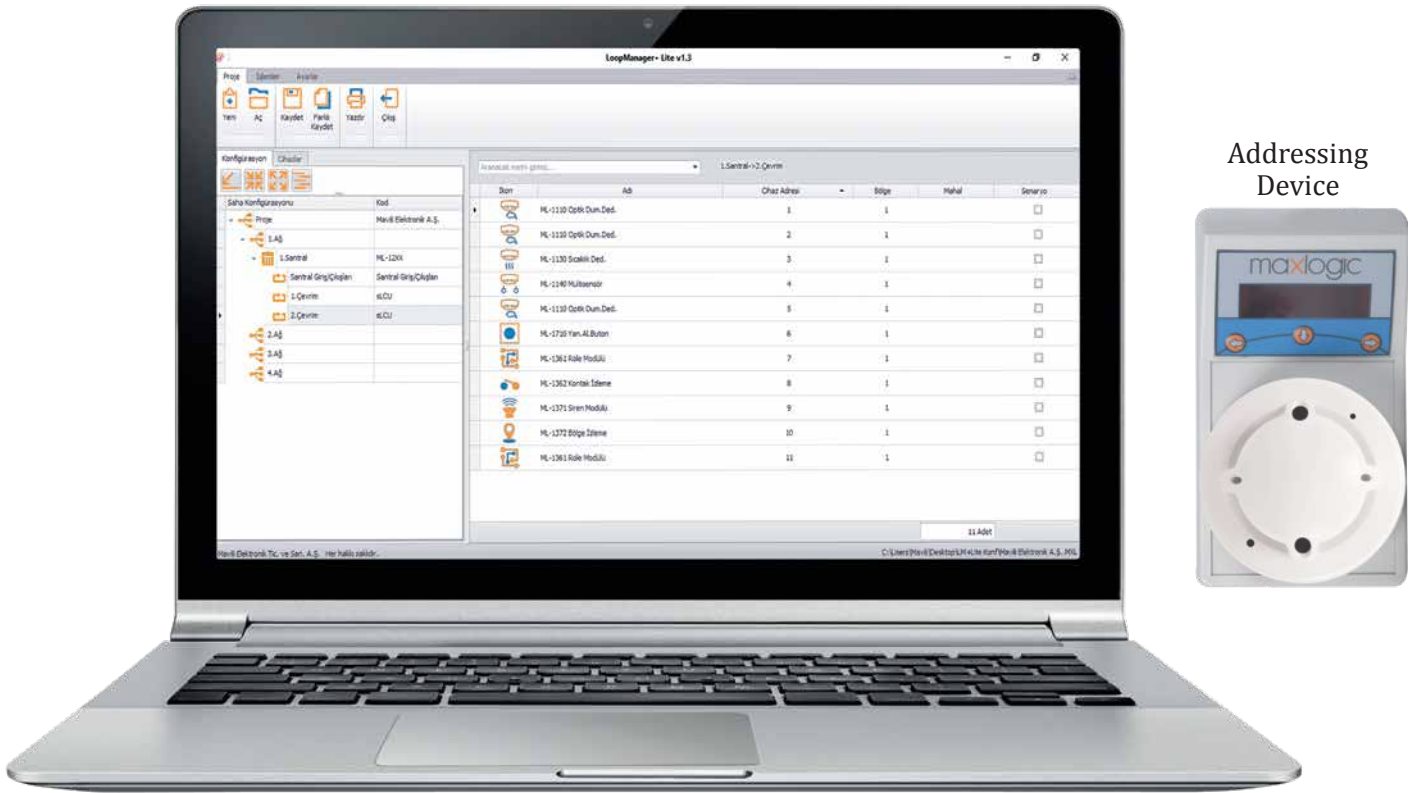

# Commissioning, Service and Maintenance Authorization for ML-122X Series

With Maxlogic intelligent addressable system ML-122X series fire alarm control panels, configuration software (LoopManager + Lite) and **Addressing Device**, you can easily commission, service and maintain.

- ▶ 4 different languages option (Turkish, English, Russian, French)
- ▶ User friendly, easy installation and use with aesthetic design
- ▶ Communication interrupt for fast fire detection in 1.5 sec
- ▶ The key is needed for entry to panel menu
- ▶ Day and night mode, pre-alarm, contamination warning

## PANEL MODELS

Product Code	Description
ML-1221	Fire alarm panel, 1 loops, 127 address
ML-1222	Fire alarm panel, 2 loops, 254 address

## ACCESSORIES and OPTIONS

Product Code	Description
ML-1613	Intelligent addressable system LoopManager + Lite software
ML-1010	Addressing device



## Graphic Monitoring and Control...

20

# 7" TFT Mimic Panel

Maxlogic Intelligent Addressable System Mimic Panel is connected as a repeater panel to a network created from the Maxlogic panels, shows graphically the location of fire incidents on the maps previously uploaded by user and send commands, such as "reset", "alarm", "cancel alarm" to networked panels. It is easy to use and has an aesthetic design.

- ▶ Mimic Manager Software for easy programming via PC
- ▶ Integration of building projects into the ML-1280 7" TFT Mimic Panel via SD card
- ▶ Possible monitoring fire events graphically via Mimic Manager software
- ▶ Layered monitoring for each device
- ▶ Several display data for each device





Ability to monitor graphically for all Maxlogic fire alarm system small site and big site applications. 7" TFT Mimic Panel contains stylish exterior design and Surface Mount Technology (SMT) production techniques.

- ▶ Automatic or manual navigation between the maps in case of fire
- ▶ Possible sending information Alarm / Alarm Silence / Reset to all panels in network
- ▶ Visual fire location information via 7" TFT screen
- ▶ Intervention to right place
- ▶ Quick intervention

**PANEL MODELS**

Product Code	Description
ML-1280	Intelligent Addressable System 7" TFT Mimic Panel

**ACCESSORIES AND OPTIONS**

Product Code	Description
ML-1621	ML-1280 7" TFT Mimic Panel Software

## Perfect Software Communication...

# Intelligent Addressable System GCU Panel

GCU panel provides communication between Maxlogic intelligent addressable fire detection system and Sprvsr+ and/or building management systems.



ML-1207.CGK  
GCU Panel

- ▶ For the communication with Sprvsr+, GCU panel uses RS-232, RS-485 for close access, IP based communication like GPRS and TCP/IP communication modules for longer distance.
- ▶ Interaction to building management systems via Modbus/Bacnet protocol.
- ▶ Connecting options of advanced modular structure with up to 16 expandable communication modules.
- ▶ GCU uses the same network with up to 63 panels.
- ▶ Through back-up working based structure, uninterrupted communication is provided.

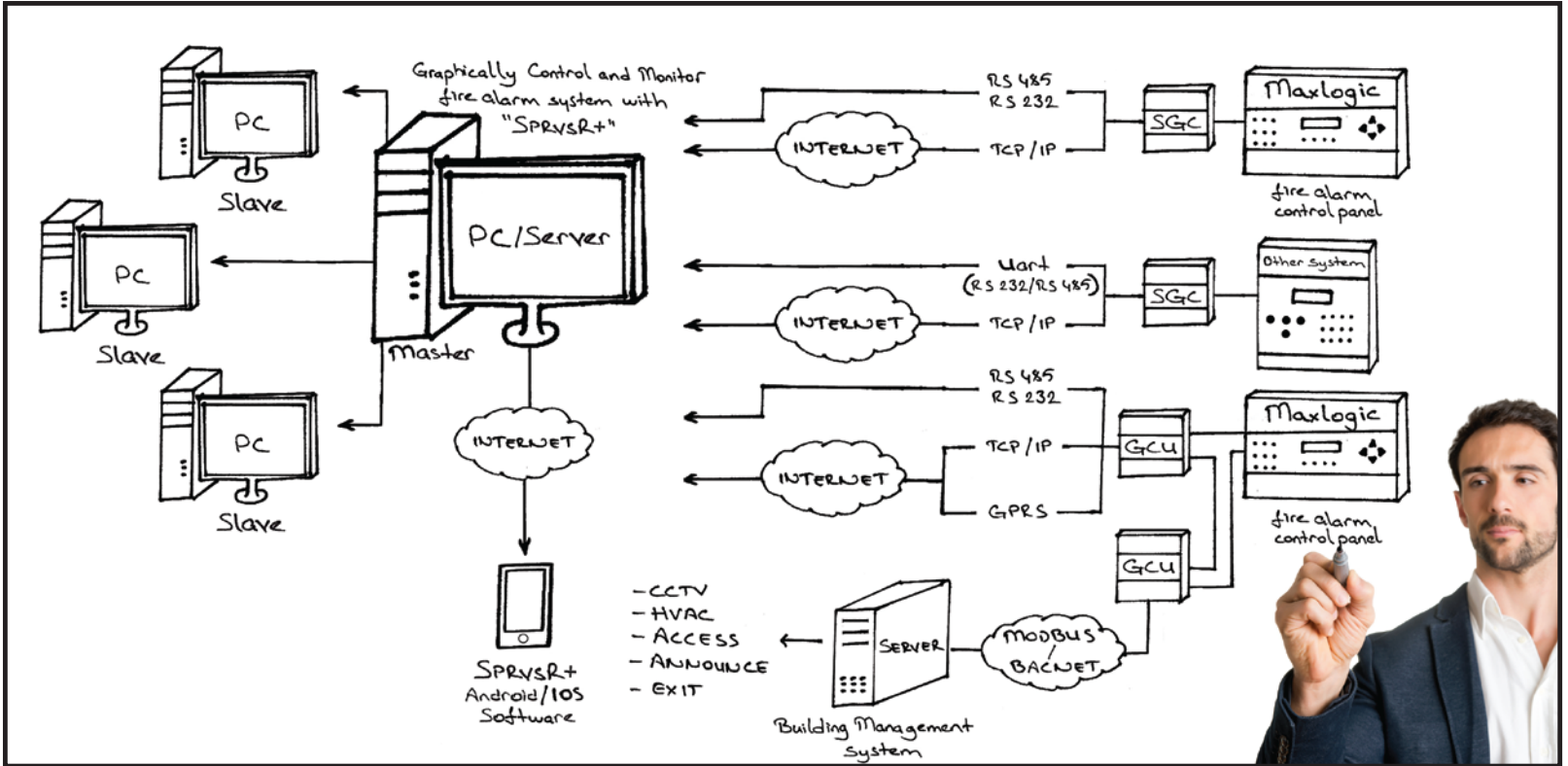

# Intelligent Addressable System Communication

- ▶ SGC Module is designed to monitor and control other systems (Maxlogic series intelligent addressable systems are excluded).
- ▶ 4 inputs (“System Fault”, “Alert”, “Fault”, “Fire”) and 4 outputs (“Alarm Silence”, “Reset”, “Alarm”, “Evacuation”) for monitoring and controlling via Sprvsr+
- ▶ With UART connection cable for short distance access, with TCP/IP via internet for long distance TCP/IP can be connected to Sprvsr+
- ▶ Through advanced redundancy structure ensure reliable and continuous communication
- ▶ Sprvsr+ Android software enables monitoring and control of fire alarm system without the user's need to be at the computer



ML-12012.UART  
Other System SGC  
Module, UART Output

ML-12012.C  
Other System SGC Module,  
TCP/IP Output

## GCU MODELS

Product Code	Description
ML-1207.K	Intelligent Addressable System GCU Panel, RS232/RS485 module included
ML-1207.C	Intelligent Addressable System GCU Panel, TCP/IP module included
ML-1207.G	Intelligent Addressable System GCU Panel, GPRS module included

## GCU MODELS

Product Code	Description
ML-1207.MX	Intelligent Addressable System GCU Panel, Modbus module included
ML-1207.B	Intelligent Addressable System GCU Panel, BACnet module included
ML-1207.CGK	Intelligent Addressable System GCU Panel, TCP/IP, GPRS, RS-232 / RS-485 modules included

## SGC MODELS

Product Code	Description
ML-12011.KU	Intelligent Addressable System SGC module, RS-232 output
ML-12011.KB	Intelligent Addressable System SGC module, RS-485 output
ML-12011.C	Intelligent Addressable System SGC module, TCP/IP output
ML-12012.UART	Other systems SGC module, UART output
ML-12012.C	Other systems SGC module, TCP/IP output





## Key Of Remote Control...

# Maxlogic SPRVSR+ Graphical Monitoring and Management Software

Sprvsr+; it is a user-friendly software, developed for remote monitoring and management of Maxlogic addressed systems and other systems.

Sprvsr+; is provides various methods for analysis with event filters by keeping records of all activities (fires, faults, user interventions, etc.) related to the fire alarm system.

- ▶ At the time of the event; the type of event, date, time, etc. can be sent by SMS or e-mail with instant or daily reporting containing information.
- ▶ 1000 networks, each consisting of 64 panels, can be monitored.
- ▶ Event log viewing, recording and printing options
- ▶ Devices can be controlled manually on the map
- ▶ Thanks to the "Easy Indicator" screen in the Sprvsr+ program, it is possible to perform control operations such as follow-up, reminder creation, database backup and restore.
- ▶ Contamination control can be activated/deactivated. Measurement periods can be determined.
- ▶ Using the simulation option; control of maps, devices and system operation can be achieved with an unreal fire event

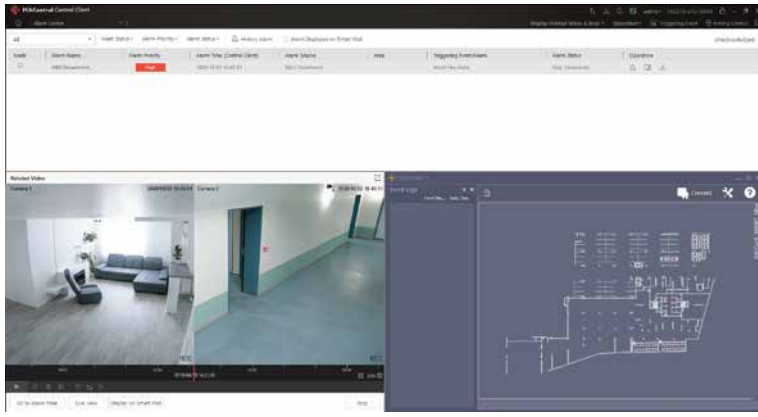

SPRVSR+ software works **software-integrated** with rooftop software and Building Management Systems (BMS).

Thanks to the **Android / IOS** software, the user does not need to be at the computer to control and monitor the fire alarm system.



# Maxlogic SPRVSR + Graphical Monitoring and Management Android / IOS Software

Thanks to SPRVSR+ Android / IOS applications, fire events occurring in the fire alarm system can be monitored and controlled graphically via mobile devices. It is possible to switch between maps during the fire alarm.

- ▶ Sending automatic or manual notification messages to LAN or remote computers defined in IP address in case of fire with Android / IOS software
- ▶ With user-based filtering feature, the user can choose to see the fire events in the network structured panels and devices connected to the panels partially or completely.
- ▶ Via the Android / IOS software, the warning message can be displayed automatically as a map at the time of the event.

## SPRVSR+ MODELS

Product code	Description
ML-1633.1.01	SPRVSR+ Master Graphical Monitoring and Management Software for 1 panel
ML-1633.1.02	SPRVSR+ Master Graphical Monitoring and Management Software for 2 panel
ML-1633.1.04	SPRVSR+ Master Graphical Monitoring and Management Software for 4 panel
ML-1633.1.08	SPRVSR+ Master Graphical Monitoring and Management Software for 8 panel
ML-1633.1.16	SPRVSR+ Master Graphical Monitoring and Management Software for 16 panel
ML-1633.1.32	SPRVSR+ Master Graphical Monitoring and Management Software for 32 panel
ML-1633.1.64	SPRVSR+ Master Graphical Monitoring and Management Software for 64 panel
ML-1633.1.128	SPRVSR+ Master Graphical Monitoring and Management Software for 128 panel
ML-1633.1.256	SPRVSR+ Master Graphical Monitoring and Management Software for 256 panel
ML-1633.1.512	SPRVSR+ Master Graphical Monitoring and Management Software for 512 panel
ML-1633.1.1024	SPRVSR+ Master Graphical Monitoring and Management Software for 1024 panel
ML-1633.1.2048	SPRVSR+ Master Graphical Monitoring and Management Software for 2048 panel
ML-1633.1.4096	SPRVSR+ Master Graphical Monitoring and Management Software for 4096 panel
ML-1633.1.8192	SPRVSR+ Master Graphical Monitoring and Management Software for 8192 panel

## SPRVSR+ MODELS

Product code	Description
ML-1633.2.01	SPRVSR+ Slave Graphical Monitoring and Management Software for 1 panel
ML-1633.2.02	SPRVSR+ Slave Graphical Monitoring and Management Software for 2 panel
ML-1633.2.04	SPRVSR+ Slave Graphical Monitoring and Management Software for 4 panel
ML-1633.2.08	SPRVSR+ Slave Graphical Monitoring and Management Software for 8 panel
ML-1633.2.16	SPRVSR+ Slave Graphical Monitoring and Management Software for 16 panel
ML-1633.2.32	SPRVSR+ Slave Graphical Monitoring and Management Software for 32 panel
ML-1633.2.64	SPRVSR+ Slave Graphical Monitoring and Management Software for 64 panel
ML-1633.2.128	SPRVSR+ Slave Graphical Monitoring and Management Software for 128 panel
ML-1633.2.256	SPRVSR+ Slave Graphical Monitoring and Management Software for 256 panel
ML-1633.2.512	SPRVSR+ Slave Graphical Monitoring and Management Software for 512 panel
ML-1633.2.1024	SPRVSR+ Slave Graphical Monitoring and Management Software for 1024 panel
ML-1633.2.2048	SPRVSR+ Slave Graphical Monitoring and Management Software for 2048 panel
ML-1633.2.4096	SPRVSR+ Slave Graphical Monitoring and Management Software for 4096 panel
ML-1633.2.8192	SPRVSR+ Slave Graphical Monitoring and Management Software for 8192 panel

## IOS MODELS

Product code	Description
ML-1635.1	SPRVSR+ Graphical Monitoring and Management IOS Software, 1 Users
ML-1635.5	SPRVSR+ Graphic Monitoring and Management IOS Software, 5 Users
ML-1635.10	SPRVSR+ Graphic Monitoring and Management IOS Software, 10 Users

## ANDROID MODELS

Product code	Description
ML-1634.1	SPRVSR+ Graphic Monitoring and Management Android Software, 1 Users
ML-1634.5	SPRVSR+ Graphic Monitoring and Management Android Software, 5 Users
ML-1634.10	SPRVSR+ Graphic Monitoring and Management Android Software, 10 Users

# SPRVSR+ Software Features

## SPRVSR+ Master - Slave Functioning

- ▶ There must be at least one Sprvsr + master in the system in order to perform important operations such as starting connections with all GCUs from a single channel and to perform remote control and control operations.
- ▶ While operations such as communication, monitoring and control with all GCU connections can be done on the computer with the Master Sprvsr + software, monitoring and some restricted control operations can be done on the computer with the Slave Sprvsr + software installed.
- ▶ In situations requiring intervention, Silence Alarm, Alarm etc. commands can also be sent via Sprvsr+.
- ▶ Maxlogic Sprvsr+ Graphical Monitoring and Management Software; Maxlogic addressed panels are point-based, and other brands of panels are panel-based; It allows remote monitoring, control and storage of event logs.

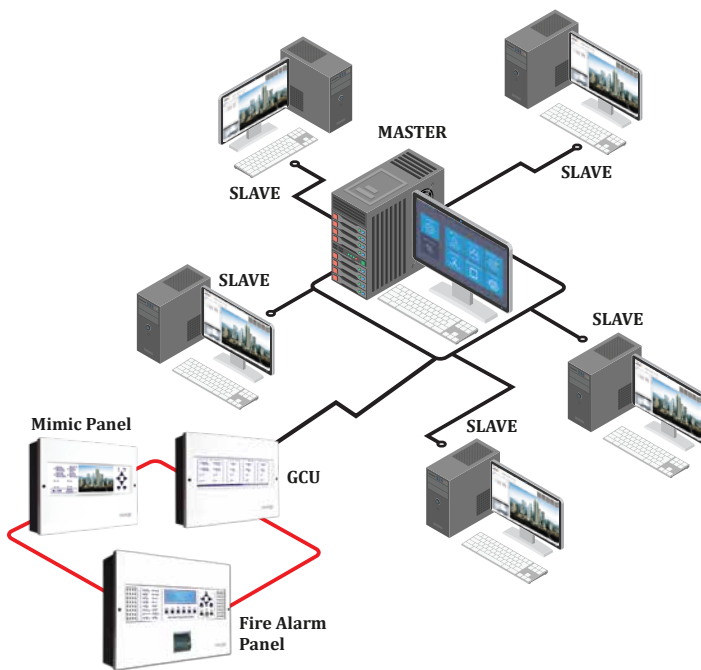

**Overall Status:** It shows the events of fire, fault etc. in the fire alarm system in detail.

**Connections:** It shows the connection status of the modules connected to the panel.

**Event Logs:** It shows the events of fire, fault etc. in the fire alarm system.

**Cameras:** It shows the connection status of the cameras connected with the devices in the fire alarm system.

**System Status:** It shows the monitoring status of the fire alarm system has started or not.

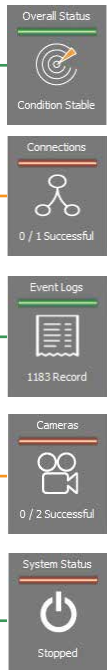



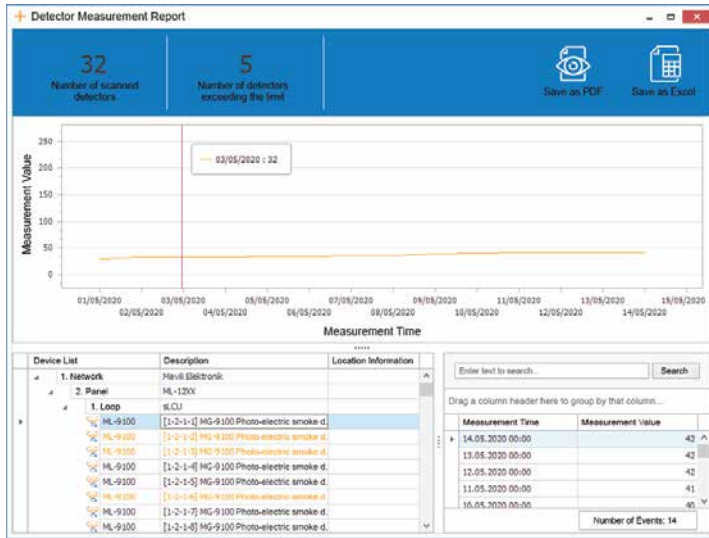

Contamination control periods can be determined for the detectors.

At the time of the event; SMS or E-mail can be sent with instant or daily reporting including the type, date, time, etc. of the event.

The screenshot shows an 'Event Logs' window with a table of events. The table has columns for Event Name, Event Date, Network Address, Panel Address, Loop Address, Device Address, Zone, Location Text, Device Type, Included Map, Event Description, and User. The events include Silence Button, Silence Alarm, Alarm Active, Fire Alarm, Reset Button, and Device Output.

Event Name	Event Date	Network Address	Panel Address	Loop Address	Device Address	Zone	Location Text	Device Type	Included Map	Event Description	User
Silence Button	06.08.2020 14:...	1	1								
Silence Alarm	06.08.2020 14:...	1	1								
Alarm Active	06.08.2020 14:...	1	1								
Fire Alarm	06.08.2020 14:...	1	1				1. KAT KIRISDI - ML-1730-SC2 B.	2. Kat		Genel alarm	
Reset Button	06.08.2020 14:...	1	1				1. KAT KIRISDI - ML-1730-SC2 B.	3. Kat			
Silence Button	06.08.2020 14:...	1	1								
Silence Alarm	06.08.2020 14:...	1	1								
Alarm Active	06.08.2020 14:...	1	1								
Fire Alarm	06.08.2020 14:...	1	2	1	7		1. KAT ACIL OK - ML-1730-SC2 B.	1. Kat		Genel alarm	
Device Output	06.08.2020 14:...	1	2	1	8		1. KAT DAMPER - ML-1396SC2 Da.	1. Kat		Genel alarm	
Alarm Active	06.08.2020 14:...	1	2	1	8		1. KAT DAMPER - ML-1396SC2 Da.	1. Kat			
Device Output	06.08.2020 14:...	1	2	1	6		1. KAT DAMPER - ML-1396SC2 Da.	1. Kat			
SCU-Modül Co.	06.08.2020 14:...	1	1								
SCU-Modül Co.	06.08.2020 14:...	1	1								
Reset Button	06.08.2020 13:...	1	1								
Device Output	06.08.2020 13:...	1	2	1	8		1. KAT DAMPER - ML-1396SC2 Da.	1. Kat			
Danger Active	06.08.2020 13:...	1	2	1	8		1. KAT DAMPER - ML-1396SC2 Da.	1. Kat			
Danger Active	06.08.2020 13:...	1	2	1	8		1. KAT DAMPER - ML-1396SC2 Da.	1. Kat			
Device Output	06.08.2020 13:...	1	2	1	8		1. KAT DAMPER - ML-1396SC2 Da.	1. Kat			
Reset Button	06.08.2020 13:...	1	1								



In the event of a fire, the location of fire can be monitored via the IP camera system.

By adding the maps where the devices are located on maps in the Sprvsr+ software, it is possible to monitor the location graphically at the time of the event. It can be determined point by point on which device the alarm signal comes from.

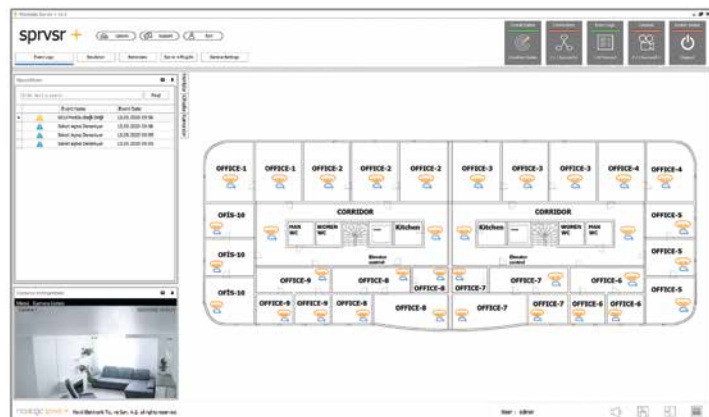

## Advanced Technology Smart Solutions...



# Maxlogic Intelligent Addressable Smoke Damper Modules

Developed by Mavili Electronics, Smoke Damper Module provides optimum and integrated operation of ventilation systems and fire alarm systems. Maxlogic Smoke Damper Module eliminates the need to manage a smoke damper with **multiple relays and switch monitoring modules**. Maxlogic Smoke Damper Module can perform multiple tasks with a single address in intelligent addressable fire alarm systems.



- LEDs that give the operating information of the module: **Green LED** for power, **Yellow LED** for fault, **Red LED** for alarm, green LED lighting up continuously when damper is open or close (green led flashing when damper is opened/closed)

- Comply to **EN 54-18**, models with short circuit isolators comply with **EN 54-17** standards.
- 220V AC, 24V DC and 24V AC operating voltage options to suitable for all smoke dampers
- On / Off** buttons for manually opening and closing the damper, **On / Off** inputs for switching on and off with remote control
- Open / Short circuit** monitoring of damper remote control inputs
- Damper Fault** shows when opening the damper module cover as designed
- Damper output line, remote control input, position monitoring input, detection of **open / short** circuit faults
- Open, Closed** and **Damper Fault** locations of the dampers can be seen from the panel event logs and the screen of the panel
- Damper opening and closing times can be set to **30, 60, 120, 240 seconds**, for **Position Monitoring** inputs



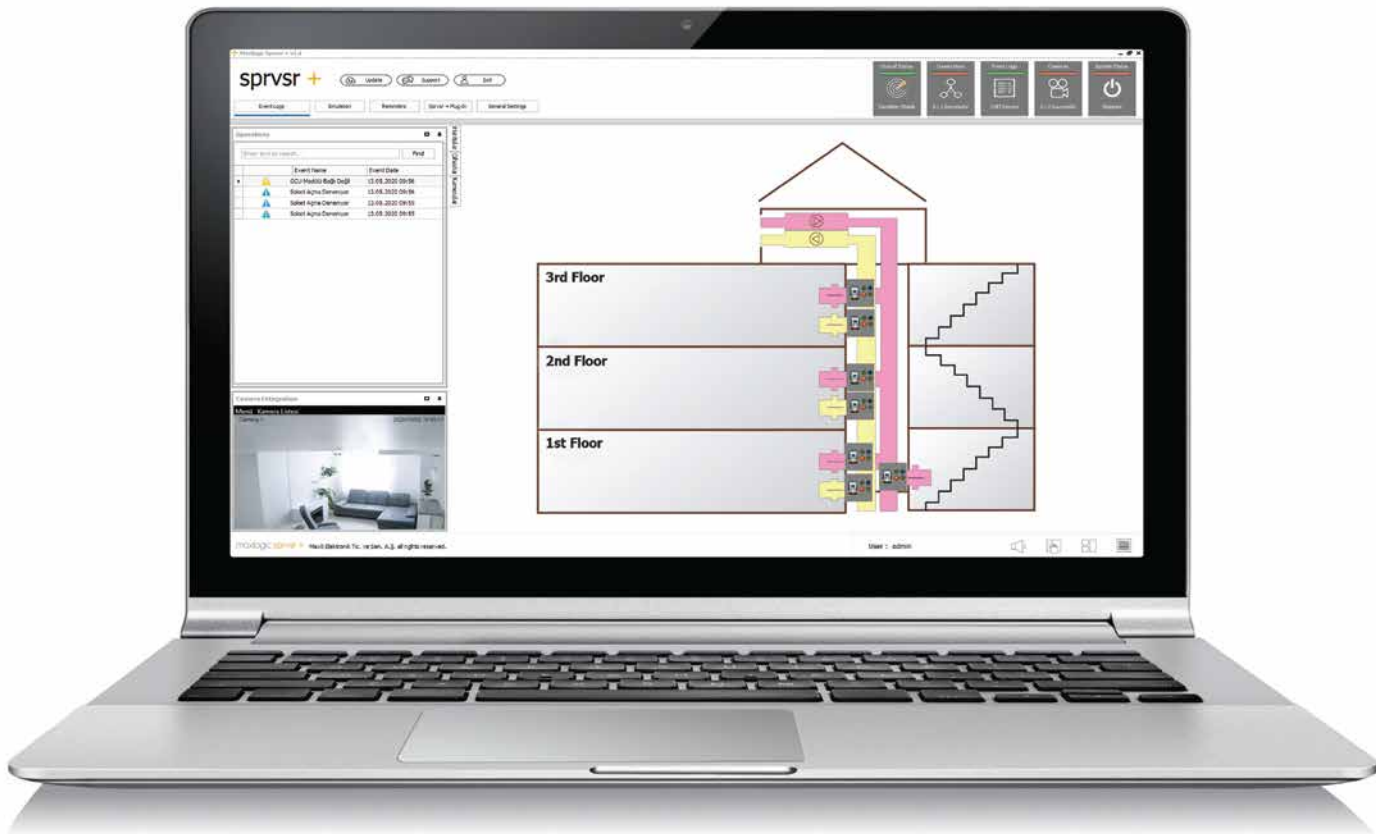

## Smoke Damper Control with Sprvsr+ Software

- ▶ **Damper Fault** can be seen on the screen if the damper that does not change position within the delay time
- ▶ **Controlling damper motors with one address and monitoring position switches**
- ▶ Monitoring of **Open, Closed and Damper Fault** positions of Smoke Dampers
- ▶ **Open / Closed** commands can be send to Smoke Dampers
- ▶ Smoke Dampers can be monitored for “**Fault**” conditions
- ▶ **Loop Manager +** software configuration can provide module **Zone Numbers** and **Location Information**
- ▶ Inclusion of scenarios to enable **Smoke Dampers** to be opened and smoke evacuation at the location of a fire. Also, the **Smoke Dampers** can be turned off in other rooms connected to the channel to prevent smoke from entering other rooms.
- ▶ Scenario to prevent the entry of smoke into escape routes such as stairs by operating the **Pressurized Damper** in case of fire
- ▶ If required for security reasons, **1st Level** and **2nd Level Delay** assignments can be made to enable **Smoke Dampers** to be opened and closed in a delayed mode.





### MODELS

Product Code	Description
ML-1353	16 Way I/O Panel (8 input / 8 output)
ML-1354	Intelligent addressable system smoke damper control panel, 16 way I/O module
ML-1355	Intelligent addressable system smoke damper control panel with toggle switch, 16 way I/O module
ML-1356	Maxlogic intelligent addressable system smoke damper module, 1 output, 24V DC
ML-1356.SCI	Maxlogic intelligent addressable system smoke damper module, 1 output, 24V DC, with short circuit isolator
ML-1357	Maxlogic intelligent addressable system smoke damper module, 1 output, 24V AC
ML-1357.SCI	Maxlogic intelligent addressable system smoke damper module, 1 output, 24V AC, with short circuit isolator
ML-1358	Maxlogic intelligent addressable system smoke damper module, 1 output, 220V AC
ML-1358.SCI	Maxlogic intelligent addressable system smoke damper module, 1 output, 220V AC, with short circuit isolator



# Normal Condition





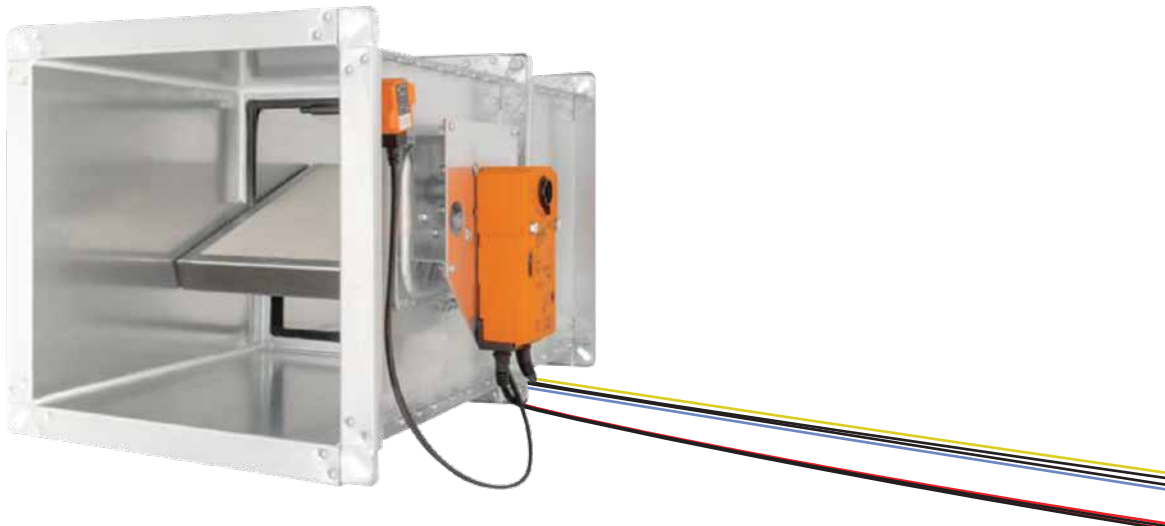
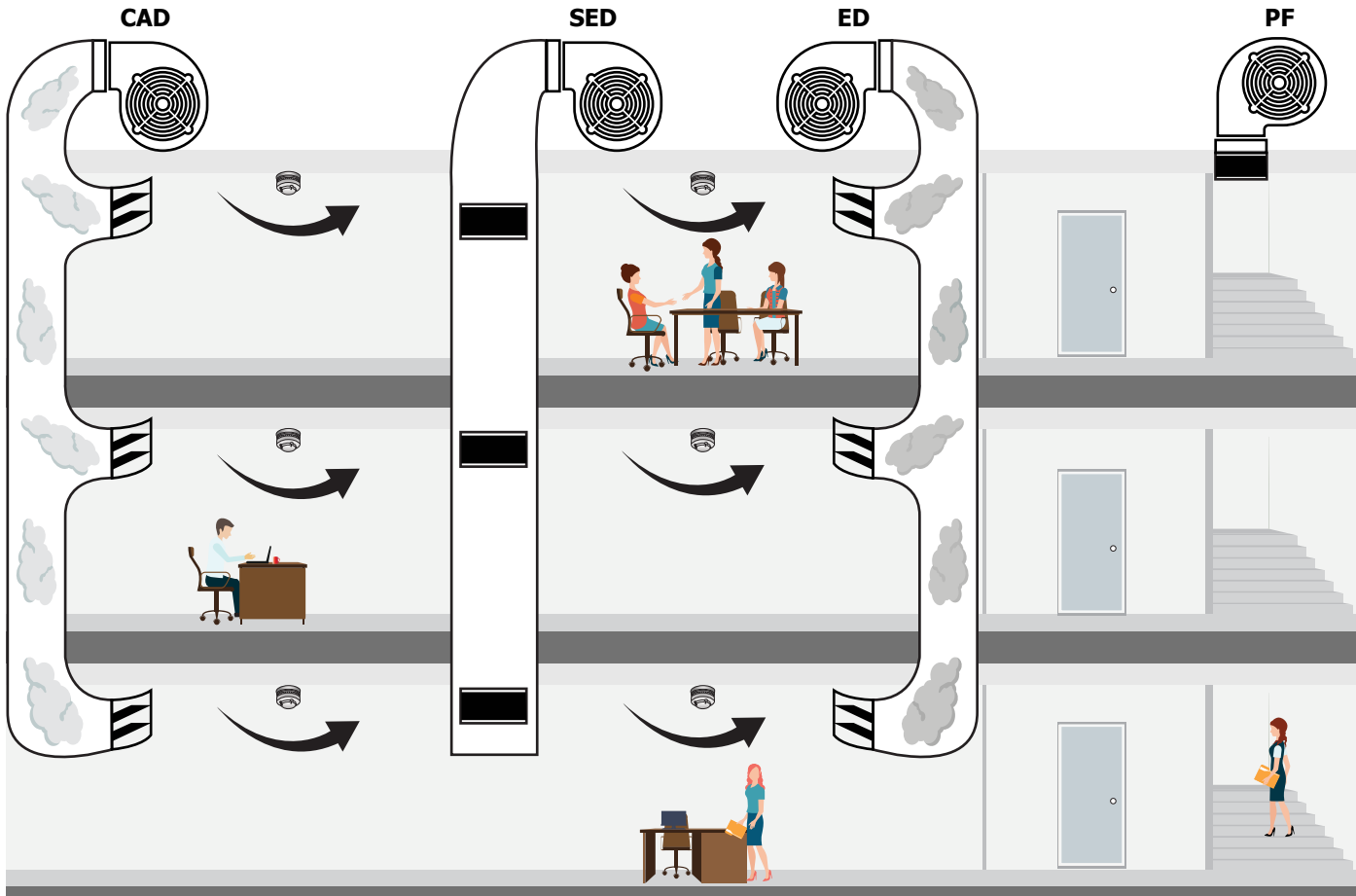

In buildings, fresh air is supplied to the environment through **Clean Air Ducts (CAD)**. The dirty air is discharged through the **Exhaust Ducts (ED)**.

CHANNEL	DESCRIPTION	NORMAL STATUS
CAD	Clean Air Ducts	ALL OPEN 
SED	Smoke Exhaust Ducts	ALL CLOSED 
ED	Exhaust Ducts	ALL OPEN 
PF	Pressurization Fans	CLOSED 



# Fire Condition

In case of fire in the buildings, the **Clean Air Ducts (CAD)** in the area they are located are closed to extinguish the fire. **Smoke Exhaust Ducts (SED)** and **Exhaust Ducts (ED)** are used to discharge smoke from the environment. To ensure the use of the stairs, compressed air is supplied to the stairs using the **Pressurization Fans (PF)**, thus limiting the passage of smoke.

CHANNEL	DESCRIPTION	FIRE ZONE STATUS	STATUS OF OTHER ZONES
CAD	Clean Air Ducts	CLOSED 	OPEN 
SED	Smoke Exhaust Ducts	OPEN 	CLOSED 
ED	Exhaust Ducts	OPEN 	CLOSED 
PF	Pressurization Fans	OPEN 	

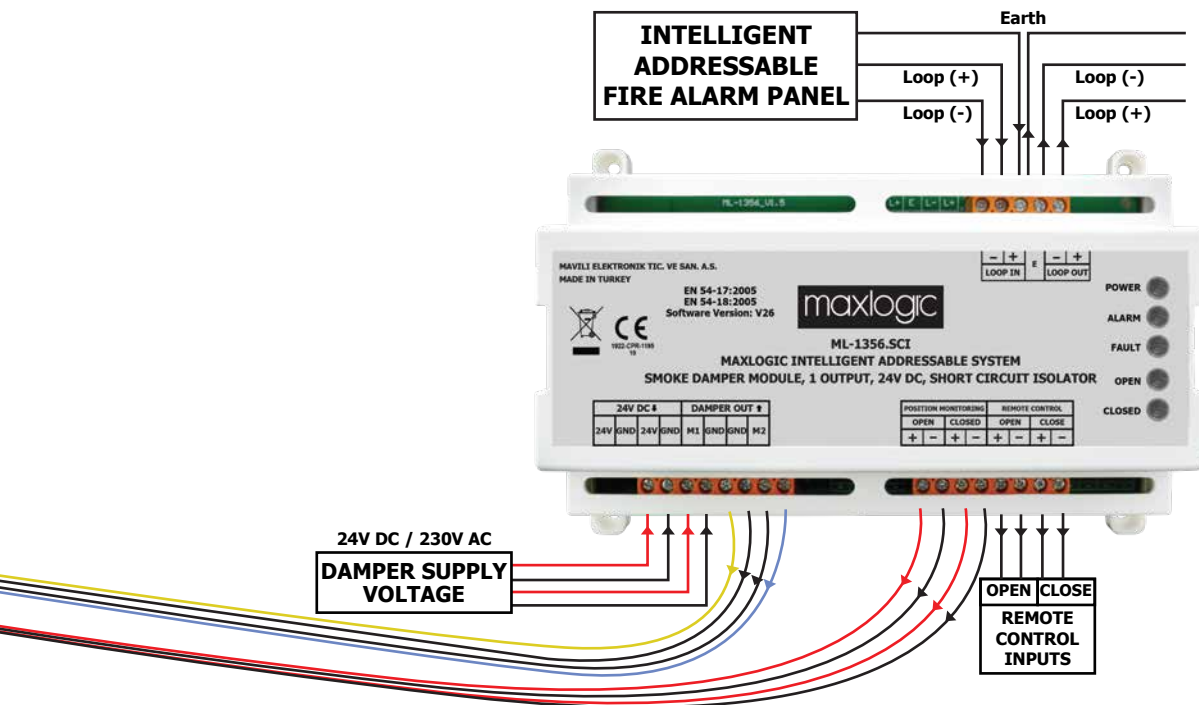
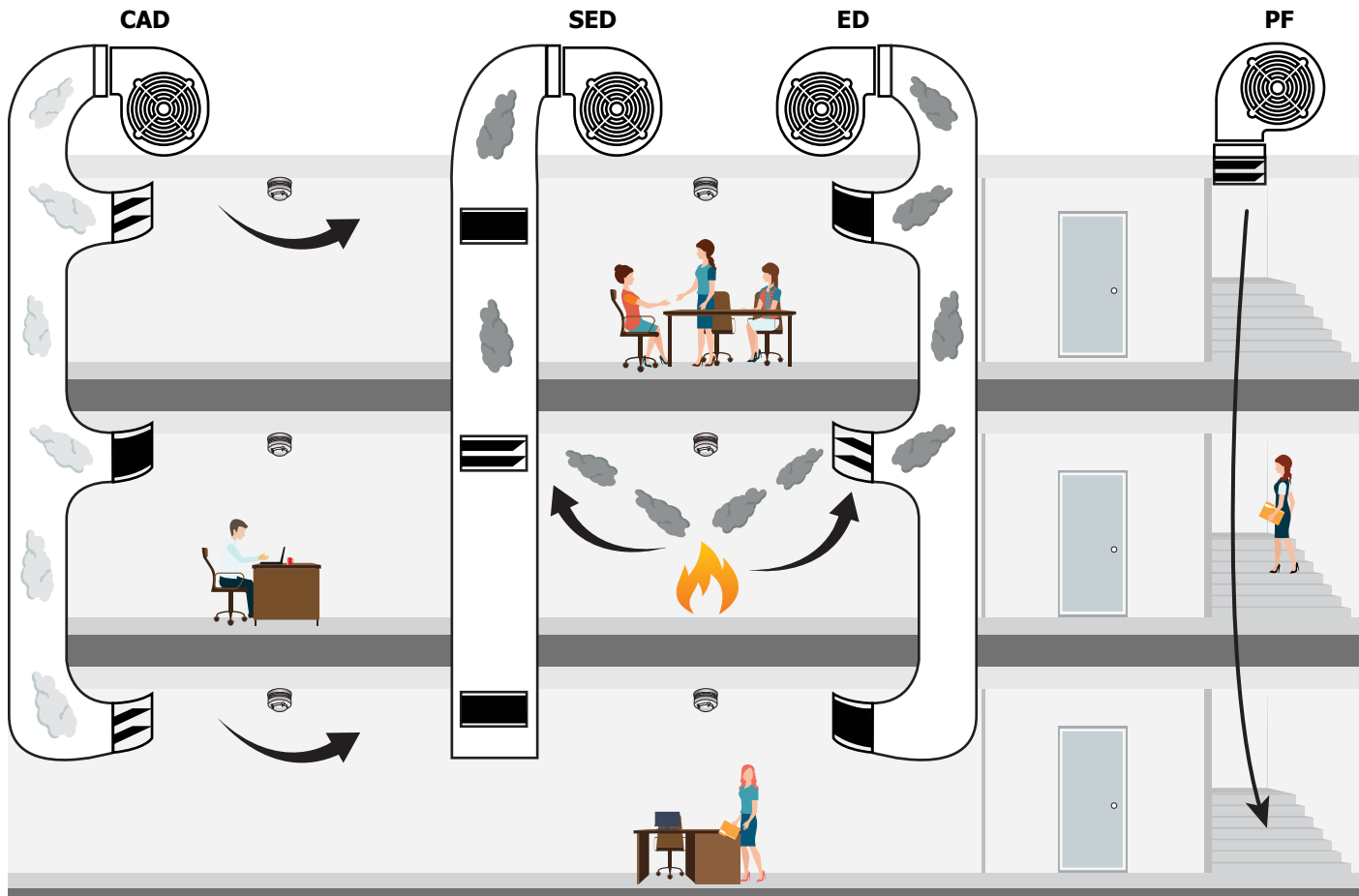



32

## Safe and Fast Communication...

# Firefighter's Telephone Control Unit

Firefighter's telephone control unit; in case of an emergency, allows the communication of authorized people with the security center or other of firefighter's telephone units.



Firefighter's Telephone Control Unit

Firefighter's Telephone Unit

### Firefighter's Telephone Control Unit

Through Firefighter's telephone unit, no need to dial for calling the fire telephones on panels and security center of firefighter's telephones. When any user call the security center, other users can be involved automatically by picking-up the handset and conference call can be done without any intervention of operator.

### Firefighter's Telephone Unit

Firefighter's Telephone Unit can be applied in a different location from the panel and can be integrated into communication with the system.



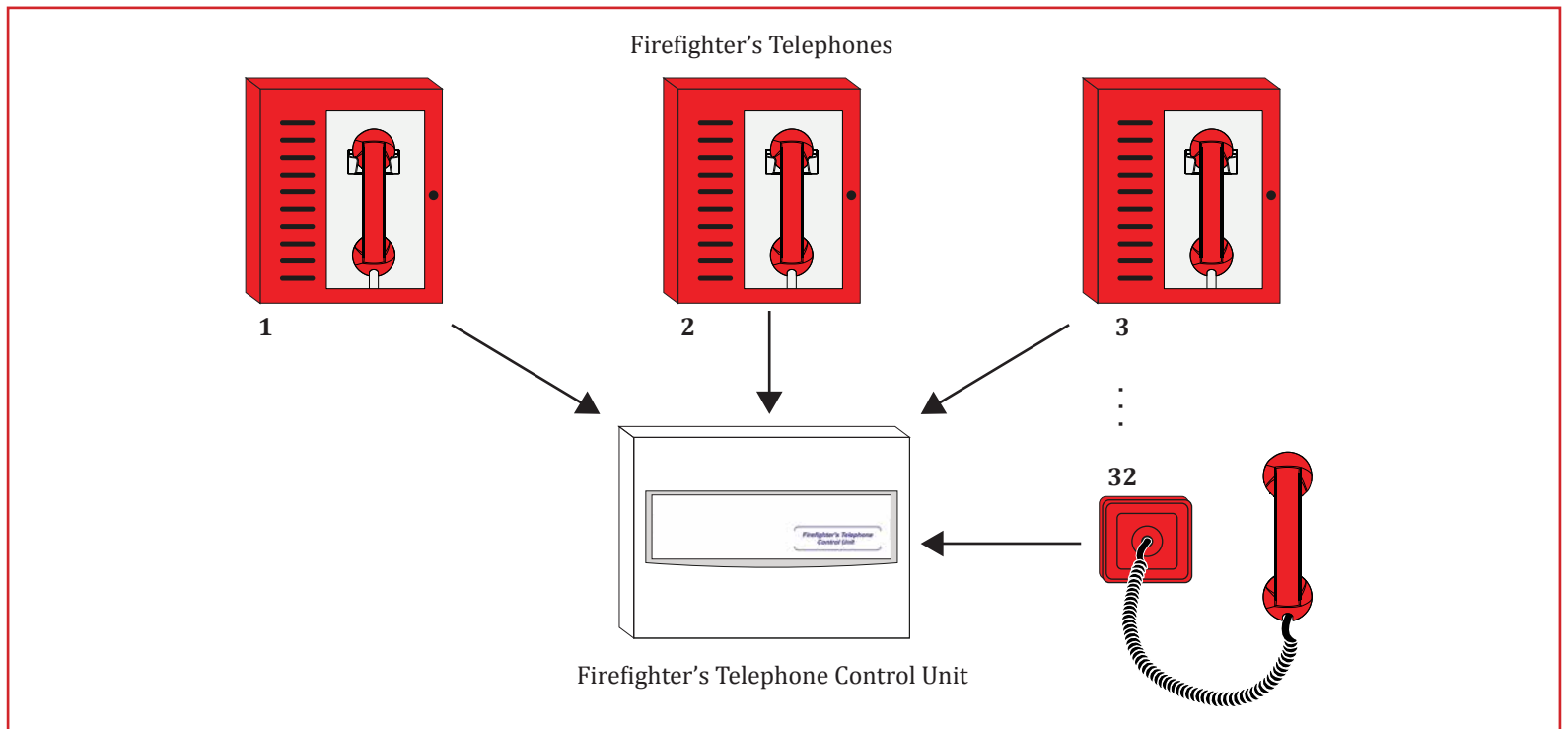

In case of an emergency, lifting a handset of firefighter's telephone or inserting a portable firefighter's telephone handset in the socket and without the need of dialing any number automatically calls the security center by "hot line" feature.





## Intelligent Integration of Advanced Systems...

# Announce / Alarm Matrix Panel

Announce / Alarm matrix panel provides the integration with announcement system.



ML-5020  
Maxlogic Announce / Alarm Matrix Panel,  
19", 3U Rack Structure

- ▶ Compatible with 19", 3U rack
- ▶ Modular structure expandable up to 16 modules
- ▶ Modules can be selected as announce microphone input and / or programmable alarm / warning output
- ▶ Up to 32 units of announce module connection inputs
- ▶ Ability perform announcement in 8 zone with the help of 60 announce microphone
- ▶ Possibility to perform announcement with pre-recorded messages in required zones
- ▶ Led indicators for communication and fault events
- ▶ LED indicators for active announce modules and active relay outputs
- ▶ Internal power supply

# Announce System

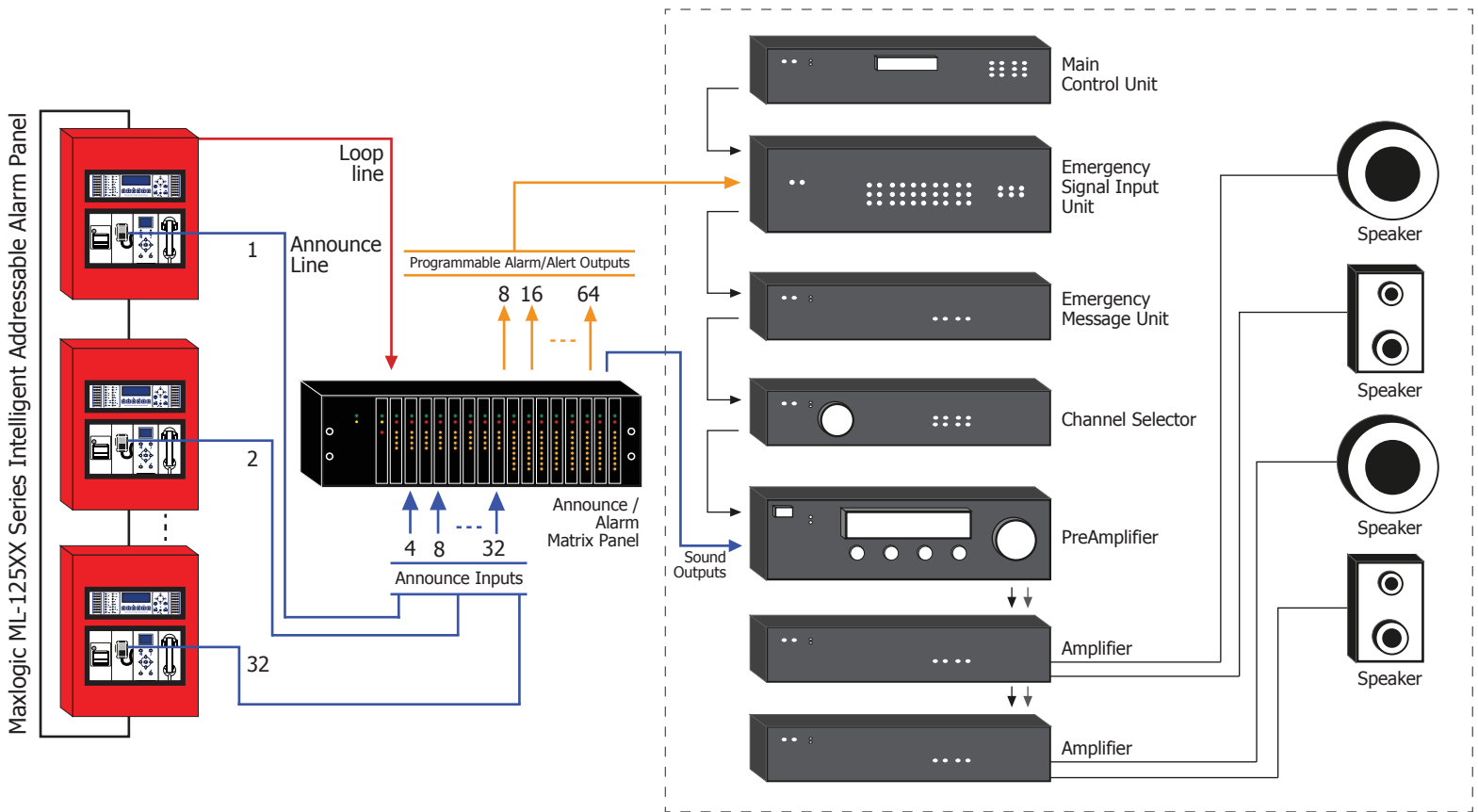

- ▶ Live announcement feature via present announce system to the determined areas by authorized people is provided with using internal announce module on Intelligent addressable fire panels.
- ▶ When fire and/or emergency situation occurs; with using Alarm/Alert output modules, it provides an automatic announce with pre-recorded messages or sound records via present announce system to the determined areas.

## MODELS

Product code	Description
ML-5020	Maxlogic announce/alarm matrix panel, 19", 3U Rack, announce power module and internal power output
ML-5020.AI	Maxlogic announce input module
ML-5020.PO	Maxlogic programmable alarm/alert output module
MLY-5001	Maxlogic announce/alarm matrix blank panel





36

## Managing and Control in Your Hands...

# Intelligent Addressable System Input / Output Modules

Monitor and control modules, offering high performance by the VIP communication protocol, can be configured to operate in cause-effect scenario and fire automation can be performed.



ML-1373.SCI  
Intelligent Addressable System  
2/1 I/O Module  
(2 Inputs / 1 Output),  
with Short Circuit Isolator

ML-1366.SCI  
Intelligent Addressable System  
4/2 I/O Module (4 Inputs / 2 Outputs),  
with short circuit isolator

- ▶ Compatible with EN 54-17 and EN 54-18
- ▶ Optional short circuit isolator models
- ▶ LED-indicated activation, fault, and communication status
- ▶ Easy mounting with rail system
- ▶ 2/1 I/O module with 2 zone monitoring inputs  
1 sounder output option or 2 dry contact monitoring inputs  
1 dry contact relay output option
- ▶ 4/2 I/O module with 4 dry contact monitoring inputs  
2 dry contact relay outputs option

# Dry Contact Input / Output Modules

Modules are loop-powered and can be programmed to operate in cause-effect scenarios. External systems can be monitored by switch monitor inputs and can be controlled by relay outputs within fire automation.

Switch monitor inputs are used for monitoring external dry switch relay output. Switches have normally open and normally close operate features. In case of changing of switch position, event type that is detected by panels can be determined by users.

The module has one relay output with voltage-free, bipolar contact max. load of 30V DC, 1A. The relay can operate as normally open or normally close.

The models have SCI, internal short circuit isolator, in case of short circuit events, isolates the line.



# Energy Input / Output Modules

Energy Input/Output needs 18V-30V DC external power supply and that can be monitored in case of fault event and programmable for cause-effect scenarios.

Zone monitoring Inputs are used to monitor the conventional type detectors and manual call points. In case of change of Input status, events type that are detected by panel can be determined by users.

24V DC 500mA sounder output can be activated within fire automation as required. 24V DC 500mA sounder output can be arranged according to event type that is determined by users.

With SCI models, internal short circuit isolator, in case of short circuit events, isolates the line.

## MODELS

Product Code	Description
ML-1361	Maxlogic intelligent addressable system relay control module, 1-way output
ML-1361.SCI	Maxlogic intelligent addressable system relay control module, 1-way output, with short circuit isolator
ML-1362	Maxlogic intelligent addressable system switch monitor module, 1-way input
ML-1362.SCI	Maxlogic intelligent addressable system switch monitor module, 1-way input, with short circuit isolator
ML-1363	Maxlogic intelligent addressable system 2/1 I/O module (2 inputs / 1 output)
ML-1363.SCI	Maxlogic intelligent addressable system 2/1 I/O module (2 inputs / 1 output), with short circuit isolator
ML-1366	Maxlogic intelligent addressable system 4/2 I/O module (4 inputs / 2 outputs)
ML-1366.SCI	Maxlogic intelligent addressable system 4/2 I/O module (4 inputs / 2 outputs), with short circuit isolator
ML-0320	Maxlogic intelligent addressable system 2-I/O module protection box

## MODELS

Product Code	Description
ML-1371	Maxlogic intelligent addressable system sounder control module, 1-way output
ML-1371.SCI	Maxlogic intelligent addressable system sounder control module, 1-way output, with short circuit isolator
ML-1372	Maxlogic intelligent addressable system zone monitor module, 1-way input
ML-1372.SCI	Maxlogic intelligent addressable system zone monitor module, 1-way input, with short circuit isolator
ML-1373	Maxlogic intelligent addressable system 2/1 I/O module (2 inputs / 1 output)
ML-1373.SCI	Maxlogic intelligent addressable system 2/1 I/O module (2 inputs / 1 output), with short circuit isolator
ML-1380	Maxlogic intelligent addressable system short circuit isolator module
ML-1390	Maxlogic intelligent addressable system short circuit isolator module
ML-0320	Maxlogic intelligent addressable system 2-I/O module protection box





# Aesthetic and Technologic Genius...

## Intelligent Addressable Loop-powered Base Sounder / Sounder Beacon / Mounting Base c/w Buzzer

Maxlogic Intelligent addressable loop-powered base sounder is designed for indoor use, in case of fire, user is warned by audible and visible warnings. Sounders are microprocessor controlled and outputs can be programmed to work within cause-effect scenarios. Mounting base c/w buzzer, in case of detector alarm, the internal buzzer of mounting base is activated.



- ▶ Compatible with EN 54-3 and EN 54-23
- ▶ Specially designed for indoor use
- ▶ Loop-powered
- ▶ 85 dB sound output, 8 tones and volume control
- ▶ It can be used as a stand alone sounder/sounder beacon
- ▶ Its primary application is to be installed under intelligent analogue addressable smoke and heat detectors to provide both detection and alarm at the same point, reducing wiring and installation costs

### MODELS

Product Code	Description
ML-1101	Addressable loop powered base sounder
ML-1102	Addressable loop-powered base sounder beacon
ML-0141	Mounting base c/w buzzer



# Intelligent Addressable System Sounder / Beacon / Sounder & Beacon / Weatherproof

Intelligent addressable sounder, beacon, sounder & beacon / weatherproof; designed for intelligent addressable system, with full VIP communication protocol compatibility.



ML-1430.SCI  
Intelligent addressable system sounder & beacon with short circuit isolator

ML-1410.SCI  
Intelligent addressable system sounder with short circuit isolator



ML-1490.SCI  
Intelligent Addressable System Sounder & Beacon, Weatherproof (IP65), Short Circuit Isolator

ML-1440.SCI  
Intelligent Addressable System Sounder, Weatherproof (IP33), Short Circuit Isolator

- ▶ Compatible with EN 54-3 / EN 54-23
- ▶ Short circuit isolator models compatible with EN 54-17
- ▶ 'Soft' addressable by use of address programmer
- ▶ Easily programmable by Loop Manager
- ▶ Able to integrate into the cause effect scenarios
- ▶ Stable sensitivity
- ▶ Suitable for outdoor use
- ▶ Compatible with all addressable fire alarm control panels
- ▶ PCB protected by metal case
- ▶ Aesthetic design
- ▶ Production by surface mount technology
- ▶ Adjustable different 32 voice tone options
- ▶ IP33 / IP65 high protection class options

## MODELS

Product Code	Description
ML-1410	Intelligent addressable system sounder
ML-1410.SCI	Intelligent addressable system sounder with short circuit isolator
ML-1420	Intelligent addressable system beacon
ML-1420.SCI	Intelligent addressable system beacon with short circuit isolator
ML-1430	Intelligent addressable system sounder & beacon
ML-1430.SCI	Intelligent addressable system sounder & beacon with short circuit isolator
ML-1440	Intelligent addressable system sounder, weatherproof (IP33)
ML-1440.SCI	Intelligent addressable system sounder, weatherproof (IP33), short circuit isolator
ML-1450	Intelligent addressable system beacon, weatherproof (IP33)
ML-1450.SCI	Intelligent addressable system beacon, weatherproof (IP33), short circuit isolator

## MODELS

Product Code	Description
ML-1460	Intelligent addressable system sounder & beacon, weatherproof (IP33)
ML-1460.SCI	Intelligent addressable system sounder & beacon, weatherproof (IP33), short circuit isolator
ML-1470	Intelligent addressable system sounder, weatherproof (IP65)
ML-1470.SCI	Intelligent addressable system sounder, weatherproof (IP65), short circuit isolator
ML-1480	Intelligent addressable system beacon, weatherproof (IP65)
ML-1480.SCI	Intelligent addressable system beacon, weatherproof (IP65), short circuit isolator
ML-1490	Intelligent addressable system sounder & beacon, weatherproof (IP65)
ML-1490.SCI	Intelligent addressable system sounder & beacon, weatherproof (IP65), short circuit isolator

# Intelligent Addressable Manual Call Point

Design according to the EN 54-11 standards, with easy to install and easy to use features and useful accessories, the addressable fire alarm manual call points offer advanced and stable working performance.



ML-1730.SCI  
Intelligent addressable system manual call point weatherproof (IP67) resettable, short circuit isolator

ML-1710  
Intelligent addressable system manual call point, resettable

ML-1710.SCI  
Intelligent addressable system manual call point, resettable, short circuit isolator

- ▶ Compatible with EN 54-11 / EN 54-17
- ▶ Surface mount or flush mount
- ▶ Compatible with all addressable fire alarm control panels
- ▶ Microprocessor controlled
- ▶ Short circuit isolator models
- ▶ LED indicated activation
- ▶ Transparent protection cover
- ▶ Easy resettable
- ▶ Stable sensitivity
- ▶ Communication interrupt for fast fire alarm detection in 1.5 sec.
- ▶ Production by surface mount technology

## MODELS

Product Code	Description
ML-1710	Intelligent addressable system manual call point, resettable
ML-1710.SCI	Intelligent addressable system manual call point, resettable, short circuit isolator
ML-1730	Intelligent addressable system manual call point, weatherproof (IP67), resettable
ML-1730.SCI	Intelligent addressable system manual call point, weatherproof (IP67), resettable, short circuit isolator
ML-0710	Transparent protection cover





**Fast  
and Stable  
Detection...**

41

## Superflow Air Duct Sampling Unit

Superflow air duct sampling unit is used to detect smoke in ventilation ducts and combines a smoke detector and an adaptor system where both venturi pipe and housing are specially designed for optimum airflow through the smoke detector.

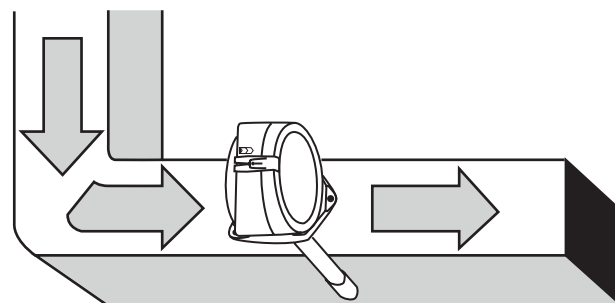

- ▶ The system fulfills all the requirements for safe fire detection with airflow speeds from 0.2 m/s to 20 m/s
- ▶ Air sampling tube: Material aluminum and the length is 0.6 m (dia)
- ▶ Foolproof pipe mounting, cannot be fitted incorrectly
- ▶ Test hole in cover
- ▶ ABS constructed with IP 54 rating



## Excellent Compatibility of Hardware and Software...

42

# Intelligent Addressable Fire Detectors

Intelligent addressable fire detectors, offering high performance by the VIP communication protocol, provide a high level of reliability as a result of stable detection feature.

- ▶ Compatible with EN 54-5, EN 54-7 and EN 54-17
- ▶ Microprocessor controlled
- ▶ Twin fire alarm indicators for 360° viewing
- ▶ Remote indicator output
- ▶ Optional short circuit isolator module
- ▶ Easy mounting and dismantling
- ▶ RY LED glows Red in case of fire, Yellow in case of pollution and fault conditions
- ▶ Compatible with ML-0121 series surface mounting back box
- ▶ Compatible with ML-0150 series recessed mounting base



ML-1110.SCI  
Optical smoke detector  
with short circuit isolator

ML-1130.SCI  
Heat detector  
with short circuit isolator

ML-1140.SCI  
Multisensor detector  
with short circuit isolator



**Intelligent Addressable Optical Smoke Detector, with short circuit isolator**

Photo electric smoke detectors utilize the IR light scatter principle. The chamber is designed for protection from dust, insects and other external interferences. Through short circuit isolator, the line is isolated in case of short circuit.

**Intelligent Addressable Heat Detector, with short circuit isolator**

Heat detector detects temperature change by temperature-sensitive thermistors. The detector can work either as a fixed heat or rate of rise heat detector. Through Short circuit isolator, the line is isolated in case of short circuit.



**Intelligent Addressable Multisensor Detector, With Short circuit isolator**

The multi-sensor detectors have a photo-electric smoke detection chamber and a temperature-sensitive thermistor. The chamber is designed for protection from dust, insects and other external interferences. Through short circuit isolator, the line is isolated in case of short circuit.

**MODELS**

Product Code	Description
ML-1110	Optical smoke detector
ML-1130	Heat detector
ML-1130BS	Class BS heat detector with mounting base
ML-1140	Multi-sensor detector
ML-1110.SCI	Optical smoke detector, with short circuit isolator
ML-1130.SCI	Heat detector, with short circuit isolator
ML-1140.SCI	Multi-sensor detector, with short circuit isolator
ML-0140	Detector mounting base
ML-0141	Mounting base c/w buzzer
ML-0144	Detector mounting base (B class)
ML-0150	Recessed mounting base
ML-0121	Weatherproof surface mounting back box



# Stable Detection and Architectural Integrity...



## Recessed Mounting Base & Address Numerators

Recessed mounting base is used for mounting conventional and addressable detectors on false ceilings of various types (like metal, plaster etc.). The base allows creating more aesthetic architectural applications. Bases are produced from ABS and have the same color as detectors. Bases are mounted into ceiling material with minimum two clamps and stainless steel screws.

They have an ergonomic design and easy in implementing. In usual ceilings where placed addressable devices, they can be installed directly under the mounting bases of the detectors, and in false ceilings - under the false ceiling unit. Address numerators are designed to provide great convenience in finding the right device, in case of fault, malfunction, contamination, etc. Compatible with all mounting bases of MaxLogic / MaviGuard detectors and ceiling additions.



ML-0150  
Recessed  
Mounting Base



ML-0101  
Address Numerator and  
Labels (for 127 devices)

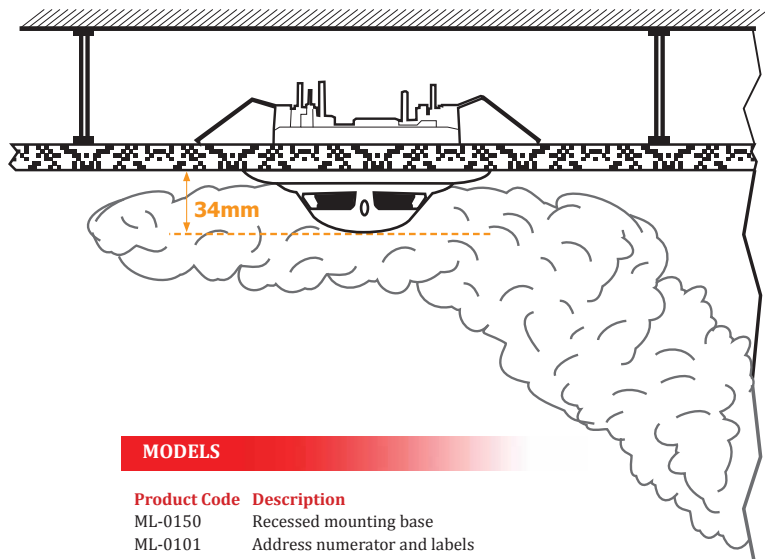

### MODELS

Product Code	Description
ML-0150	Recessed mounting base
ML-0101	Address numerator and labels (for 127 devices)
MLY-0102	Address numerator and label (for 1 device)



Designed  
for Harsh  
Environment  
Conditions...

45

## Surface Mounting Back Box



ML-0121  
Surface Mounting  
Back Box



MG-3700  
Weatherproof back  
box for fire detectors

Surface mounting back box is designed for Protection from harsh weather conditions.

### MODELS

Product Code	Description
ML-0121	Surface mounting back box
MG-3700	Weatherproof back box for fire detectors





## No More Explosion and Poisoning...

46

# Gas Detectors

User-friendly Mavigard gas detectors provide wide applicability and reliable gas detection.



Gas Detectors

- ▶ Compatible with EN 50194-1
- ▶ System normal operation condition, faults on detector and gas alarm events can be followed via LEDs
- ▶ LEDs and buzzer can be tested via test button
- ▶ 5 years sensor life under normal operating conditions
- ▶ Max. 127 gas detectors per loop
- ▶ Relay output models that work with fire and security alarm control panels
- ▶ Models with external 24V DC / 230V AC power supply
- ▶ Can be directly connected to loop
- ▶ Built-in buzzer



### LPG and Natural-gas detectors

LPG (buthane + propane) and natural-gas (methane) are hidrocarbon derivative explosive gases. The detectors respond audible and visually, before the leakage reaches %10 LEL (lower explosive limit).

### Carbon-Monoxide Detectors

Carbon-monoxide is a toxic gas with explosion risk. The detectors respond audible and visual, when the gas concentration reaches to 50 ppm (parts per million).



### Surface mounting back box

Surface mounting back box is compatible with all Maxlogic and Mavigard single field control modules and gas detectors.

### TGDR Series Ceiling Type Natural-Gas Detectors

Ceiling type gas detectors have same size and appearance with smoke detectors. Ceiling type gas detectors require mounting base.

## ADDRESSABLE GAS DETECTORS

Product code	Description
AGD-1224L.VIP	Intelligent addressable LPG detector, 24V DC
AGD-1224M.VIP	Intelligent addressable natural-gas (methane) detector, 24V DC
AGD-1224EC.VIP	Intelligent addressable carbon-monoxide detector, 24V DC, electrochemical
AGD-220L.VIP	Intelligent addressable LPG detector, 230V AC
AGD-220M.VIP	Intelligent addressable natural-gas (methane) detector, 230V AC
AGD-220EC.VIP	Intelligent addressable carbon-monoxide detector, 230V DC, electrochemical
ML-0120	Surface mounting back box

## CONVENTIONAL GAS DETECTORS

Product code	Description
GDR-1224L	LPG (buthane+propane) detector, 12/24V DC with relay
GDR-1224M	Methane (natural gas) detector, 12/24V DC with relay
GDR-220L	LPG (buthane+propane) detector, 230V AC with relay
GDR-220M	Methane (natural gas) detector, 230V AC with relay
GD2R-12EC	Carbon monoxide gas detector (CO), 12V DC, 2-level alarm output, electrochemical
GD2R-24EC	Carbon monoxide gas detector (CO), 24V DC, 2-level alarm output, electrochemical
GD2R-220EC	Carbon monoxide gas detector (CO), 230V AC, 2-level alarm output, electrochemical
TGDR-1224M	Methane (natural gas) detector, 12/24V DC with relay





Keep Your  
Eyes On The  
Heights...

48

## Intelligent Addressable Beam Type Smoke Detectors

Designed with surface mounting Technologies to detect smoke through infrared beams in places that have high and wide areas (warehouse, malls, etc.)



Beam Type Smoke Detector  
Receiver



Beam Type Smoke Detector  
Transmitter

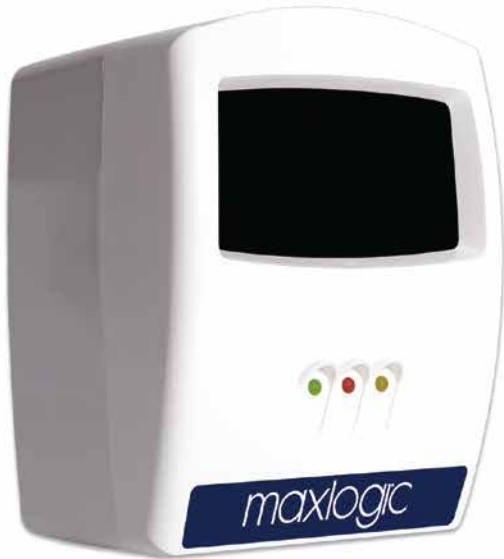

Reflective Beam Type Smoke Detector



Beam Type  
Smoke Detector Reflector  
with 1 reflector



Beam Type  
Smoke Detector Reflector  
with 4 reflector

Maxlogic beam type smoke detector consists of 2 parts; receiver and transmitter. They should be installed as facing each other between the distance of 5-100m.

Reflective beam type smoke detector consists 2 parts as a receiver/transmitter unit and reflector. Unit and reflector should be mounted as facing each other, distance is 5-35 meters with 1 reflector and 5-50 meters with using 4 reflectors.

Detectors detect the light obstruction percentage caused by the smoke created by fire.

- ▶ Intelligent addressable and conventional models
- ▶ Short circuit isolator models
- ▶ Receiver-Transmitter or reflective models
- ▶ 2 digit numerical screen for easy commissioning and setup

- ▶ With beam type smoke detector 1500 m<sup>2</sup>, with reflective beam type smoke detector 750 m<sup>2</sup> protection area
- ▶ Easy programming buttons
- ▶ LED indicators for power, fire and fault conditions

- ▶ Ability to adjust itself to polluted and dirty environment
- ▶ Three sensitivity levels can be easily adjusted
- ▶ Continuous control of communication against the faults

#### DETECTOR MODELS

##### Product code Description

ML-1170	Intelligent addressable beam type smoke detector (included receiver-transmitter)
ML-1170.SCI	Intelligent addressable beam type smoke detector (included receiver-transmitter) with short circuit isolator
ML-1173	Intelligent addressable reflective beam type smoke detector
ML-1173.SCI	Intelligent addressable reflective beam type smoke detector, with short circuit isolator
ML-2170	Conventional beam type smoke detector (receiver and transmitter is included)
ML-2173	Conventional reflector beam type smoke detector
ML-0171	Beam type smoke detector reflector, with 1 reflector
ML-0174	Beam type smoke detector reflector, with 4 reflector





## Conventional System That Can Work In a Network...

50

# Conventional Fire Detection and Alarm System

- ▶ Ability to monitor multi panels with single repeater panel through Network
- ▶ Compatible with standard all conventional fire detectors and call points
- ▶ Optional zone capacity according to application
- ▶ 32 detectors or MCP capacity for each zone
- ▶ Supervised zone and sounder lines controlled against short circuit and open circuit
- ▶ Application specific solutions via optional modules
- ▶ Easy to use with few buttons on the front panel
- ▶ All LED indicators can be tested with one button
- ▶ Aesthetic design
- ▶ PCB protection against to humidity and corrosion
- ▶ Easy to install and user friendly
- ▶ Microprocessor control
- ▶ Surface mount production technology



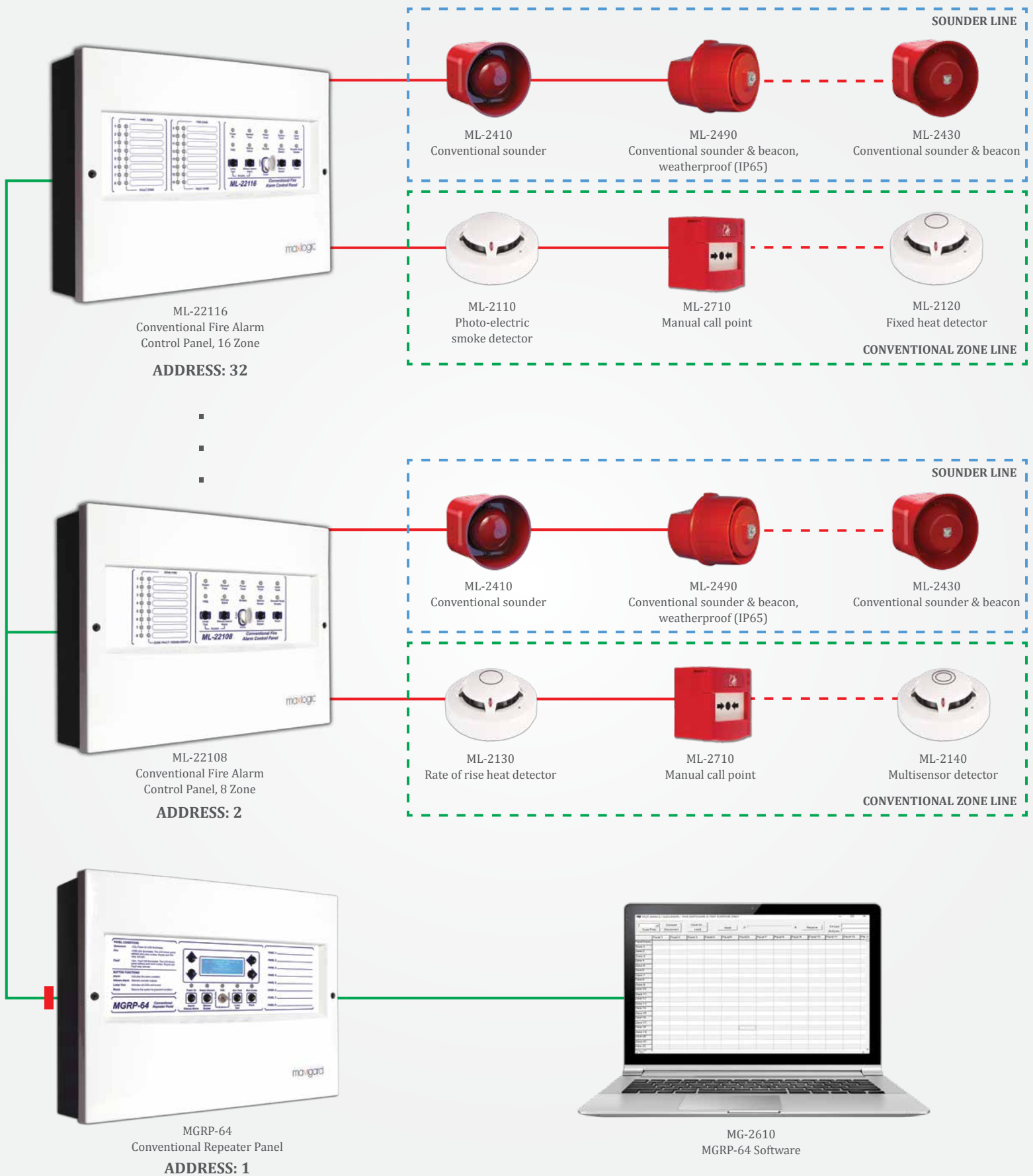

- ▶ Fire and fault are monitored through zone LEDs and piezoelectric buzzer
- ▶ Sounder, fault and fire relay outputs
- ▶ Zones can be tested with one-man, through zone test feature
- ▶ Specific zones and/or sounder outputs can be disabled through zone disable and sounder disable features
- ▶ Stable sensitivity
- ▶ Protection from electromagnetic interferences

## Reliable and Expandable Structure...

52

# Conventional Fire Alarm Control Panels

Designed to provide economical solutions for small and medium applications with modern exterior design and SMT (Surface Mount Technology) production technology.



ML-2228  
Conventional  
Fire Alarm Panel, 8 Zone

- ▶ Compatible with EN 54-2 and EN 54-4
- ▶ 2, 4 and 8 zones
- ▶ 1 sounder output, fire and fault relay outputs
- ▶ Fire and fault events can be monitored via zone fire LEDs, zone fault LEDs and piezoelectric buzzer
- ▶ User friendly with few button on front of the panel
- ▶ Stable sensitivity
- ▶ All LEDs can be tested via one button
- ▶ Zonal testing feature with one person
- ▶ Determined zones and/or sounder output can be disabled via Disable zone and disable sounder function
- ▶ Easy entrance for cable from up and back of panel
- ▶ Surface mounting technology
- ▶ Aesthetic design

# Conventional Fire Alarm Control Panels

The ML-221XX series conventional fire alarm control panels are designed to provide economical solutions for medium and big applications with modern exterior design and Surface mount technology production technology.



ML-22116  
Conventional  
Fire Alarm Panel, 16 Zone

- ▶ Compatible with EN 54-2 and EN 54-4
- ▶ 2, 4, 8 and 16 zones
- ▶ Up to 32 repeater panels and/or fire panels assembled into a network with using repeater panel
- ▶ 230V AC 50 Hz power supply input
- ▶ Delay can be assigned to zones and sounders
- ▶ Up to 1000 events log memory
- ▶ Relay module 8-way (provides zonal relay output)
- ▶ Sounder module 8-way (provides zonal sounder output)
- ▶ Panel status can be monitored via PC. reset, alarm, alarm silence commands can be sent to panel, zone test and disable features can be performed
- ▶ Easy event log transfer by RS-485 port with computer program
- ▶ 2 sounder outputs, fire alarm and fault relay

## MODELS

### Product code Description

ML-22102	Conventional fire alarm control panel, 2 zone
ML-22104	Conventional fire alarm control panel, 4 zone
ML-22108	Conventional fire alarm control panel, 8 zone
ML-22116	Conventional fire alarm control panel, 16 zone

## MODELS

### Product code Description

ML-2222	Conventional fire alarm control panel, 2 zone
ML-2224	Conventional fire alarm control panel, 4 zone
ML-2228	Conventional fire alarm control panel, 8 zone

## MODELS

### Product code Description

MGRP-64	Conventional repeater panel
MG-2610	MGRP-64 software



## New Perspective at Detection Technology...

# Conventional Fire Alarm Detectors

Ergonomic and user friendly conventional fire alarm detectors are designed for maximum protection with their stability and sensitivity.

- ▶ Compatible with EN 54-5 and EN 54-7 standards
- ▶ Twin LED indicators for 360° view
- ▶ Microprocessor controlled
- ▶ Compatible with ML-0140 series mounting base c/w relay
- ▶ Compatible with ML-0141 series mounting base c/w buzzer
- ▶ Remote indicator output
- ▶ Compatible with ML-0150 series recessed ceiling mounting back box
- ▶ Compatible with ML-0121 series surface mounting back box
- ▶ 2 pcs red LEDs (the light flashes continuously in case of fire-situation, the light flashes once per 8 second in case of normal-status, the light flashes twice per 8 second in case of fault-status)



### Detector Mounting Base

Compatible with Maxlogic conventional fire detectors.

Contact metals of ML-0140 mounting base have 301 quality and stainless type metals. These contacts are with clips in order to prevent intermittent contact.



### Detector Mounting Base c/w Buzzer

When the detector alarms, at the same time internal buzzer is activated. Compatible with all conventional system detectors.

The mounting base c/w Buzzer is powered from detector line.



### Conventional Photo-Electric Smoke Detector

Photo-electric smoke detector has an infrared photoelectric smoke detection chamber which utilizes the infrared light scatter sensing principle. The detection chamber is protected from dust, insects and other external interferences.

### Conventional combined heat detector

The detector can work either as a fixed heat or rate of rise heat detector. Fire alarm signal is generated in case of 30°C/min or higher heat rise and/or on reaching the threshold of 60°C.

### Conventional Fixed Heat Detector

The fire alarm signal generated on reaching the threshold of 60°C. For special orders, fixed heat detectors with different threshold levels can also be manufactured.



### Conventional Multi-sensor Detector

Multi-sensor has an infrared photoelectric smoke detection chamber utilizing the infrared light scatter sensing principle and a temperature-sensitive thermistor. The detection chamber is protected from dust, insects and other external interferences.

#### MODELS

Product Code	Description
ML-2110	Optical smoke detector
ML-2120	Fixed heat detector
ML-2130	Rate of rise heat detector
ML-2130BS	Class BS heat detector with mounting base
ML-2140	Multi-Sensor detector
ML-0140	Detector mounting base
ML-0141	Mounting base c/w buzzer
ML-0144	Detector mounting base (B class)
ML-0150	Recessed mounting base
ML-0121	Surface mounting back box

## Perfect Compatibility between System and Accessories...

56

# Conventional Sounder / Sounder & Beacon, Conventional Sounder / Beacon / Sounder & Beacon, Weatherproof



### Conventional Sounder

Maxlogic series conventional sounders provide stable performance in indoor applications and are compatible with all conventional panels.

- ▶ Compatible with EN 54-3
- ▶ Surface mount or flush mount
- ▶ Adjustable different 32 voice tone options
- ▶ Low or high voice power control
- ▶ Microprocessor controlled



### Conventional Sounder & Beacon

Maxlogic series conventional sounder beacon generates audible and visual signal, in addition to these features.

- ▶ Compatible with EN 54-3 and EN 54-23
- ▶ Adjustable different 32 voice tone options
- ▶ Adjustable flash frequency and coverage area
- ▶ White, strong LED flasher



### Conventional Sounder, Beacon, Sounder & Beacon, Weatherproof

Maxlogic series conventional sounders are weather-proof audible warning devices and suitable for outdoor use.

- ▶ Compatible with EN 54-3 and EN 54-23
- ▶ Adjustable different 32 voice tone options
- ▶ Adjustable flash frequency and coverage area
- ▶ IP33 / IP65 high protection class options
- ▶ Suitable for outdoor use
- ▶ White, strong LED flasher



# Sounder Expansion Panel

Compatible with all Intelligent addressable and conventional panels.



ML-0314  
Sounder expansion panel

- ▶ Compatible with EN 54-18 and EN 54-4 standards
- ▶ 4 supervised sounder output, each are 1A, 24 V DC
- ▶ Sounder outputs are supervised and continuously monitor for open and short circuit
- ▶ Direct connection to addressable and conventional systems
- ▶ Continuous control against power supply failure
- ▶ Direct supply from the batteries when the power supply is cut
- ▶ Battery charge voltage is automatically adjusted according to ambient temperature

# Conventional Manual Call Points

Designed according to the EN 54-11 standards, with easy to install and easy to use features and useful accessories, the conventional fire alarm manual call points offer superior and stable working performance.



## Conventional Manual Call Point, Resettable

The MCP is activated by manual pressing on the flexible plastic cover. The switch, normally resting on flexible plastic cover, changes position and retains it until it is brought into its initial position.

- ▶ Easy resettable
- ▶ Compatible with EN 54-11 standards
- ▶ Surface mount or flush mount
- ▶ Compatible with all conventional fire alarm panels
- ▶ Transparent protection cover



## Smoke Detector Tester / Sabre

Smoke detector tester is a functional testing product for ionization and optical smoke detectors.

- ▶ UL listed
- ▶ Non-flammable
- ▶ Non-toxic
- ▶ Easy to use

- ▶ Does not damage the detector
- ▶ High speed draft
- ▶ Doesn't damage plastic surface and internal structure
- ▶ No silicon content, ozone friendly with no CFCs

### MODELS

Product code	Description
ML-2710	Manual call point, resettable
ML-0710	Transparent protection cover
ML-0314	Sounder expansion panel
SMOKE	Smoke detector tester / sabre
SABRE 01-001	

### MODELS

Product code	Description
ML-2410	Conventional sounder
ML-2420	Conventional beacon
ML-2430	Conventional sounder & beacon
ML-2440	Conventional sounder, weatherproof (IP33)
ML-2450	Conventional beacon, weatherproof (IP33)
ML-2460	Conventional sounder & beacon, weatherproof (IP33)
ML-2470	Conventional sounder, weatherproof (IP65)
ML-2480	Conventional beacon, weatherproof (IP65)
ML-2490	Conventional sounder & beacon, weatherproof (IP65)

## The Right Choice for CO Detection and Automation...

# GD2R Series Gas Detector



Conventional carbon-monoxide gas detectors detect gas leakage in closed areas like home, garage etc. Gas detectors with electrochemical sensor have stable sensitivity and high performance.

Gas detectors have 2 level threshold. When the gas in the ambient reaches 50ppm, the gas detector goes into 1st level alarm. If gas concentration reaches 200ppm, the gas detector goes into 2nd level alarm. When the gas concentration in the ambient reaches below 50 ppm, the gas detector automatically turns back to its normal operating condition.

# Conventional Gas Alarm Control Panel

Conventional Gas Alarm Control Panels, offering stable performance are produced by use of surface mount technology with modern exterior design and programmability.

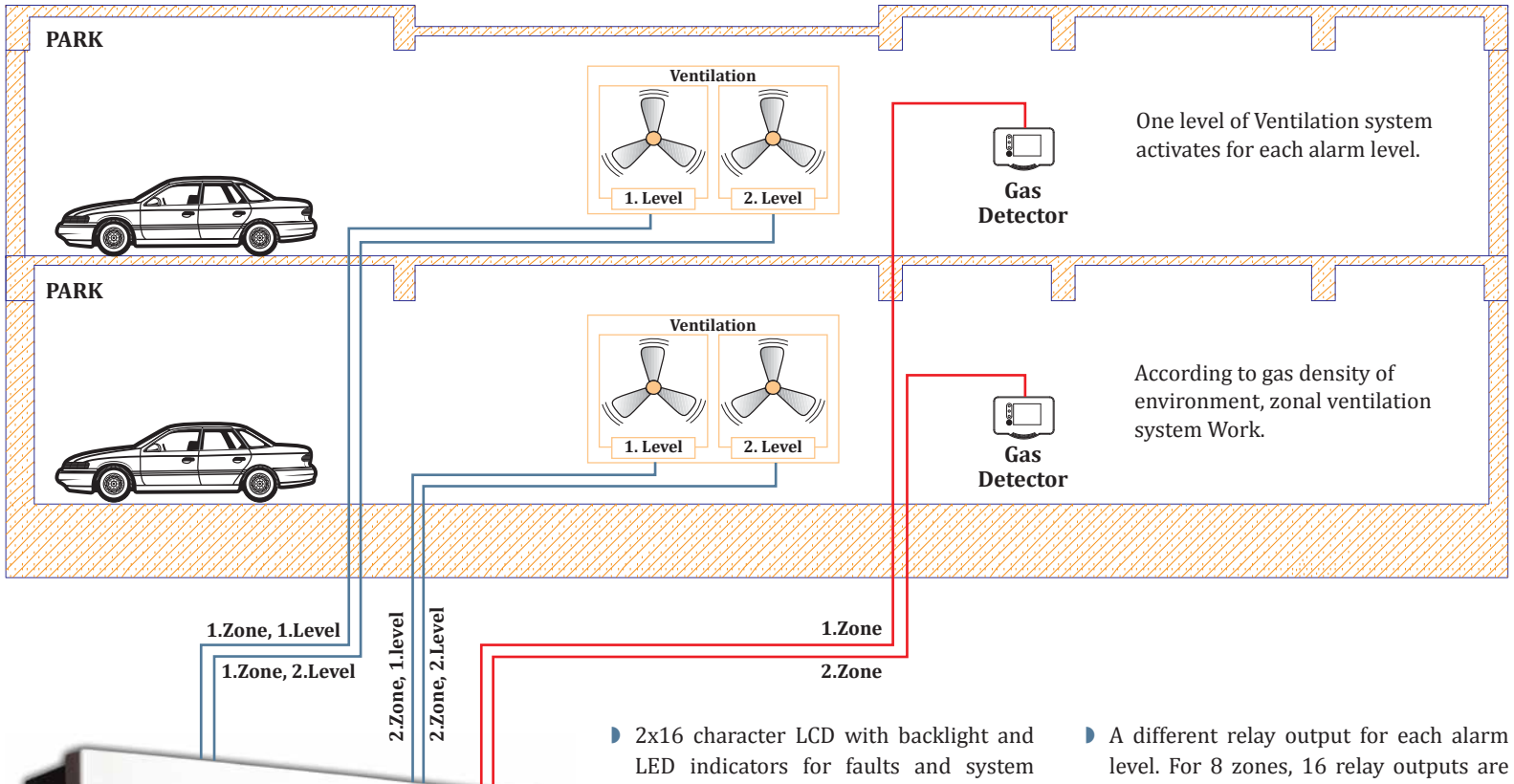

ML-4218  
Gas Alarm Control Panel

- ▶ 2x16 character LCD with backlight and LED indicators for faults and system conditions.
- ▶ Possibility to easily use via few buttons on the panel
- ▶ Supervised conventional zone inputs and sounder outputs
- ▶ 2-level alarm that gas detectors detect can be shown
- ▶ 2 alarm relays (for alarm level 1 and 2) and 1 fault relay output for controlling other devices and sending signal to other systems
- ▶ Zones can be tested and disabled.
- ▶ Input delay can be assigned to zones
- ▶ A different relay output for each alarm level. For 8 zones, 16 relay outputs are available in total.
- ▶ The panel has two sounder outputs, each rated 24V DC 500 mA
- ▶ Adjustable sounder delay
- ▶ Password-protected Access levels
- ▶ Some features of panel can be controlled by remote control inputs. System can be switched into alarm and fault mode, alarm mode can be deactivated and system can be reset by using the remote control inputs.
- ▶ 8 zone inputs
- ▶ Configurable latching gas alarm outputs

## DETECTOR MODELS

Product Code	Description
GD2R-12EC	Carbon monoxide gas detector (CO), 12V DC, 2-level alarm output, electrochemical
GD2R-24EC	Carbon monoxide gas detector (CO), 24V DC, 2-level alarm output, electrochemical
GD2R-220EC	Carbon monoxide gas detector (CO), 230V AC, 2-level alarm output, electrochemical

## PANEL MODELS

Product Code	Zone Capacity
ML-4218	8



Reliable Choice  
for Industrial  
Applications...



## Gas Alarm Control Panel, 4 Channel

The modern design panel, offering advanced programmability and high performance with its 4 channels, is widely applicable for industrial use. Panels offer many features to integrate to automations applications.



MG-400  
Gas Alarm Control Panel,  
4 Channel

- ▶ The panel has 4 channels, each capable of hosting 1 industrial type gas detector or 20 conventional fire detectors.
- ▶ Large graphic 240x64 pixels LCD with adjustable backlight displays system information, including gas detector measurements, alarms and faults.
- ▶ Adjustable high and low alarm thresholds
- ▶ Sending signals to different systems via high and low alarm relays, high level fault relay, and general fault relay

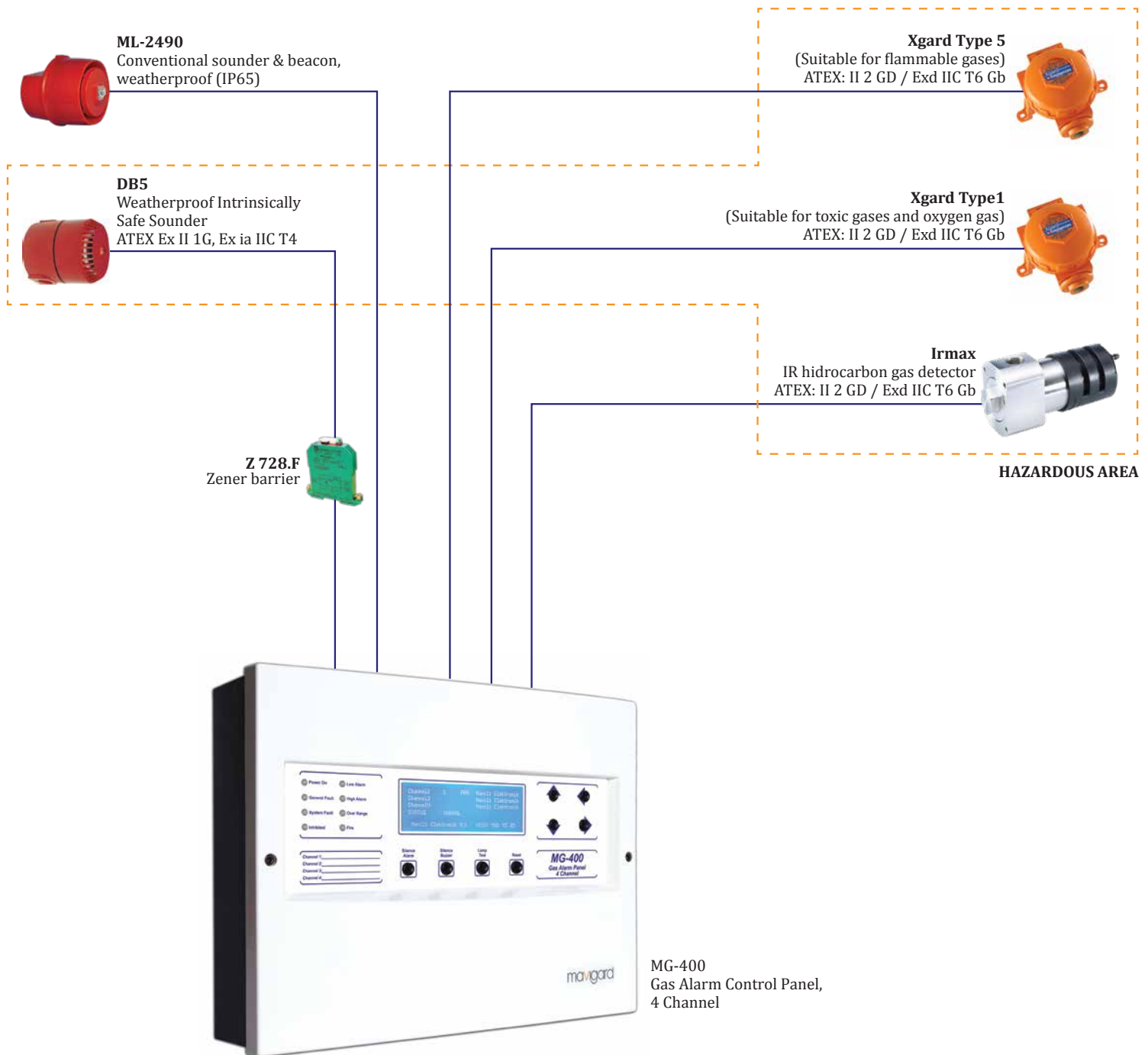

- ▶ Compatible with Industrial gas detectors and 4-20 mA converter
- ▶ Channel measurement unit can be chosen from “%LEL”, “PPB”, “PPM”, “%VOL” or “GAS”
- ▶ Latching/non-latching sounder outputs
- ▶ Desired channels can be disabled, sounder outputs and relays can be tested, gas detectors can be zeroed and calibration can be done via panel.
- ▶ High and low alarm warnings can be selected according to ambient gas density.
- ▶ Compatible with two and three wire detectors
- ▶ It is possible to enter zone location names for panels and detectors
- ▶ Latching/non-latching relay outputs
- ▶ Sink and source operating selection for channels
- ▶ Relays can be set as NO or NC
- ▶ Password access and remote control for protection against unauthorized intervention

#### MODELS

Product Code	Channel Capacity
MG-400	4



## Perfect Extinguishing Automation...

# Conventional Fire Extinguishing Control Panel

Conventional series fire extinguishing control panel operates on cross-zone principle, has 4 detection zones and one extinguishing release output which is programmable according to the zone requirements. Conventional extinguishing control panel is microprocessor controlled, offers high performance and can easily be integrated into all extinguishing projects.



ML-322  
Fire extinguishing control panel

ML-3313  
Extinguishing status indicator unit,  
with extinguishing status switch  
and releasing button

- ▶ Compatible with EN 12094-1, EN 54-2 and EN 54-4 standards
- ▶ 4 detection zones, 1 extinguishing zone
- ▶ Extinguishing-related front panel LEDs and LCD screen provide full system information
- ▶ Display of two warnings from two devices on the detection zones with fire zone LED
- ▶ Up to 8 pcs extinguishant condition indicator units can be connected to one pcs fire extinguishing panel



# Conventional Fire Extinguishing System Diagram

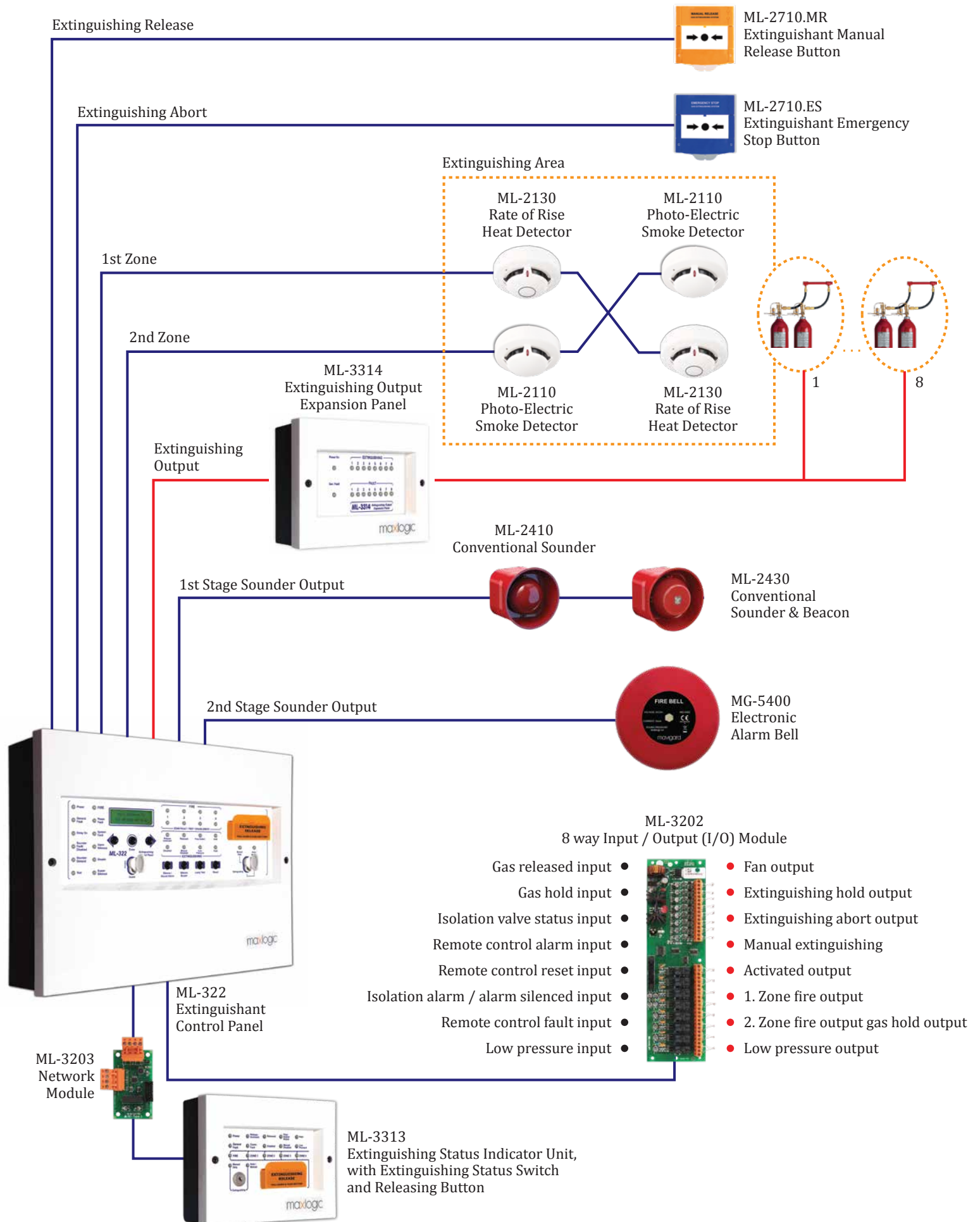

# Conventional Extinguishing System Accessories



## ML-2410 Conventional Sounder

Maxlogic series conventional sounders provide stable performance in indoor applications and are compatible with all conventional panels.

- ▶ Compatible with EN 54-3
- ▶ Surface mount or flush mount
- ▶ Adjustable different 32 voice tone options
- ▶ Low or high voice power control
- ▶ Microprocessor controlled



## ML-2420 / ML-2430 Conventional Beacon / Sounder & Beacon

Maxlogic series conventional sounder beacon generates audible and visual signal, in addition to these features.

- ▶ Compatible with EN 54-3 and EN 54-23
- ▶ Adjustable different 32 voice tone options
- ▶ Adjustable flash frequency and coverage area
- ▶ White, strong LED flasher



## ML-2710.ES Extinguishant Emergency Stop Button ML-2710.MR Extinguishant Manual Release Button

Easy to use, innovative test key designed according to EN 12094-3, advanced technology resetting function and the features of the extinguishing emergency stop button having practical accessories are below.

- ▶ Compatible with EN 12094-3
- ▶ Compatible with surface and flush mounting
- ▶ Easily resettable
- ▶ IP22D protection class



## ML-2110 / ML-2120 / ML-2130 / ML-2140 Conventional Photo-Electric / Fixed Heat / Rate of Rise Heat / Multi-Sensor Detectors

Ergonomic and user friendly conventional fire alarm detectors are designed for maximum protection with their stability and sensitivity.

- ▶ Compatible with EN 54-5 and EN 54-7 standards
- ▶ Twin LED indicators for 360° view
- ▶ Microprocessor controlled
- ▶ Remote indicator output
- ▶ 2 pcs red LEDs



## ML-3314 Extinguishing Output Expansion Panel

Extinguishing output expansion panel is used to increase the sounder output number by connecting to extinguishing output.

- ▶ Outputs can be activated as one by one according to determined delay and extinguishing time
- ▶ 8 supervised extinguishing outputs
- ▶ Determined number of extinguishing outputs are made with connecting the panels as serial



## MG-5400 Electronic Alarm Bell

Fire alarm bell is a product that can be used by all systems, from intelligent addressable fire alarm systems to conventional fire alarm systems carrying Mavigard and Maxlogic brand.

- ▶ Compatible with EN 54-3
- ▶ It generates an audible signal when it generates a warning signal in fire alarm panels and is suitable for indoor use.



- ▶ Adjustable first level delay time to sounders
- ▶ Adjustable delay time to detection zones
- ▶ Configurable delay and extinguishing time
- ▶ Non-latching zone option
- ▶ Countdown clock until the starting of extinguishing
- ▶ Fire and fault LEDs for each detection zone
- ▶ Supervised zone detection inputs, extinguishing hold input, extinguishing abort input, extinguishing activation input, low pressure input.
- ▶ Real time clock
- ▶ Supervised extinguishing output, second level sounders, gas release output
- ▶ Extinguishing mode can be changed remotely with extinguishing status key input
- ▶ Fire and fault relays
- ▶ Dry contact relay output for fire and fault
- ▶ Dry or energized contact options for outputs
- ▶ Favorable structure for integration with mechanical systems
- ▶ Cross-zone operation can be selected to be active/passive via PC software
- ▶ Up to 1000 events log memory
- ▶ Event log can be monitored via PC software
- ▶ Sending event log via RS-232 to PC or printer
- ▶ There are two extinguishing operating types; automatic and manual or manual only
- ▶ Detection zones can be tested or disabled, 1. and 2. Level relay output, extinguishing output and extinguishing abort button can be disabled
- ▶ Inputs and outputs of panel, inputs and outputs of expansion module can be programmed via special PC software. Possibility of assigning gas active, remote alarm, remote reset and many more features to the inputs

#### PANEL MODELS

Product code	Detection zone	Extinguishing zone
ML-322	4	1

#### ACCESSORIES

Product code	Description
ML-3313	Extinguishing status indicator unit, with extinguishing status switch and releasing button
ML-3314	Extinguishing output expansion panel
ML-3610	Ex Manager software for ML-322
ML-2110	Conventional photo-electric smoke detector
ML-2120	Conventional fixed heat detector
ML-2130	Conventional rate of rise heat detector
ML-2140	Conventional multisensor detector
MG-5400	Electronic alarm bell
ML-2410	Conventional sounder
ML-2420	Conventional beacon
ML-2430	Conventional sounder & beacon
ML-2710.MR	Extinguishant manual release button
ML-2710.ES	Extinguishant emergency stop button
ML-3202	8 way input / output (I/O) module
ML-3203	Network module
ML-0710	Transparent protection cover
MLY-0237	Plastic seal, 1
MLY-0238	Plastic seal, 5-pack





## Our Marine Type Systems in International Waters...

# LLOYD Certified Marine Type Fire Alarm Control System

All marine products have, **TURK LLOYD (SOLAS 74 and FSS)**, **WHEELMARK** and **IACS (International Association of Classification Societies Ltd.)** member "Russian Maritime Register of Shipping" type approval certificate.

### Intelligent Addressable System Features

- ▶ Modular structure from 1 loop to 8 loops
- ▶ Model option with thermal printer
- ▶ Microprocessor controlled
- ▶ 1000 event log memory
- ▶ Loop polling in 7.5 sec
- ▶ Communication interrupt for fast fire alarm detection in 1.5 sec
- ▶ Up to 1000 cause-effect scenarios can be created for each panel

### Conventional System Features

- ▶ 2, 4, 8 and 16 zone capacity
- ▶ Microprocessor controlled
- ▶ Stable sensitivity
- ▶ PCB protection against to humidity and corrosion

### Fire Extinguishing Control Panel

- ▶ 4 detection zones, 1 extinguishing zone
- ▶ Extinguishing-related front panel LEDs and LCD screen provide full system information
- ▶ Delay and extinguishing time can be adjusted
- ▶ Solenoid valve or actuator can be connected to the extinguishing output

## Marine Series Products

The products in this section have the Russian, MED or / and Turkish Loyd type approval certificate.  
 "Russian Maritime Register of Shipping / Type Approval Certificate" is acceptable for all of IACS members' vessels.  
 \* Marked products have the Turkish Loyd certificate as well.

### INTELLIGENT ADDRESSABLE FIRE ALARM CONTROL PANELS AND REPEATER PANELS

Product code	Description
ML-1230.N/M	Fire Alarm panel, 0 loop (**)(**)
ML-1231/M	Fire alarm panel, 1 loops, 127 address
ML-1232/M	Fire alarm panel, 2 loops, 254 address (*)
ML-1233/M	Fire alarm panel, 3 loops, 381 address
ML-1234/M	Fire alarm panel, 4 loops, 508 address (*)
ML-1235/M	Fire alarm panel, 5 loops, 635 address
ML-1236/M	Fire alarm panel, 6 loops, 762 address (*)
ML-1237/M	Fire alarm panel, 7 loops, 889 address
ML-1238/M	Fire alarm panel, 8 loops, 1016 address (*)
ML-1241.P/M	Fire alarm panel, 1 loops, 127 address, printer
ML-1242.P/M	Fire alarm panel, 2 loops, 254 address, printer (*)
ML-1243.P/M	Fire alarm panel, 3 loops, 381 address, printer
ML-1244.P/M	Fire alarm panel, 4 loops, 508 address, printer (*)
ML-1245.P/M	Fire alarm panel, 5 loops, 635 address, printer
ML-1246.P/M	Fire alarm panel, 6 loops, 762 address, printer (*)
ML-1247.P/M	Fire alarm panel, 7 loops, 889 address, printer
ML-1248.P/M	Fire alarm panel, 8 loops, 1016 address, printer (*)

(\*\*) "0" (zero) loop models of fire alarm panels work as repeater.

### INTELLIGENT ADDRESSABLE FIRE ALARM CONTROL PANELS, 2 LOOPS

Product code	Description
ML-1221/M	Intelligent Addressable Fire Alarm Control Panel, 1 Loop, 127 Address
ML-1222/M	Intelligent Addressable Fire Alarm Control Panel, 2 Loops, 254 Address

### INTELLIGENT ADDRESSABLE SYSTEM INPUT/OUTPUT MODULES

Product code	Description
ML-1361/M	Relay control module, 1-way output (*)
ML-1361.SCI/M	Relay control module, 1-way output with short circuit isolator (*)
ML-1362/M	Switch monitor module, 1-way input (*)
ML-1362.SCI/M	Switch monitor module, 1-way input with short circuit isolator (*)
ML-1363/M	2/1 I/O module (2 inputs / 1 output) (*)
ML-1363.SCI/M	2/1 I/O module (2 inputs / 1 output) with short circuit isolator (*)
ML-1366/M	4/2 I/O module (4 inputs / 2 outputs) (*)
ML-1366.SCI/M	4/2 I/O module (4 inputs / 2 outputs) with short circuit isolator (*)
ML-1371/M	Sounder control module, 1-way output (*)
ML-1371.SCI/M	Sounder control module, 1-way output with short circuit isolator (*)
ML-1372/M	Zone monitor module, 1-way input (*)
ML-1372.SCI/M	Zone monitor module, 1-way input with short circuit isolator (*)
ML-1373/M	3-way I/O Module (2 inputs / 1 output) (*)
ML-1373.SCI/M	3-way I/O Module (2 inputs / 1 output) with short circuit isolator (*)
ML-1380/M	Short circuit isolator (*)
ML-1390/M	Short circuit isolator (*)
MG-6700/M	Relay control module, 250V, 8A (*)
ML-0320/M	2-I/O module protection box

### CONVENTIONAL SYSTEM FIRE DETECTORS

Product code	Description
MGR-2100/M	Photo-electric smoke detector, with relay output, 12V DC (*)
MGR-2300/M	Combined heat (rate of rise) detector, with relay output, 12V DC (*)
MGR-2400/M	Fixed heat detector, with relay output, 12V DC (*)
MGR-2400CS/M	Fixed Heat Detector with Relay Output, 90°C
MGR-2500/M	Multisensor detector, with relay output, 12V DC (*)
ML-2110/M	Photo-electric smoke detector (*)
ML-2120/M	Fixed heat detector (*)
ML-2130/M	Rate of rise heat detector (*)
ML-2130BS/M	Class BS heat detector with mounting base
ML-2140/M	Multisensor detector (*)

### CONVENTIONAL SYSTEM ACCESSORIES

Product code	Description
MG-3500/M	Universal mounting base, white
MG-3550/M	Detector mounting base (for MGR series) (*)
MG-3600/M	Recessed mounting base for detector, white (excl. Detector and base) (*)
MG-3700/M	Weatherproof back box for fire detectors (*)
ML-0140/M	Detector mounting base (*)
ML-0141/M	Mounting base with buzzer for maxlogic detectors
ML-0144/M	Detector mounting base (B class) (*)
ML-0121/M	Surface mounting back box (*)
ML-0150/M	Maxlogic recessed mounting base (*)

### INTELLIGENT ADDRESSABLE SYSTEM FIRE DETECTORS

Product code	Description
MG-9100/M	Photo-electric smoke detector (*)
MG-9300/M	Heat detector (*)
MG-9400/M	Multisensor detector (*)
ML-1110/M	Photo-electric smoke detector (*)
ML-1130/M	Heat detector (*)
ML-1130BS/M	Class BS heat detector with mounting base
ML-1140/M	Multisensor detector (*)
ML-1110.SCI/M	Photo-electric smoke detector, short circuit isolator (*)
ML-1130.SCI/M	Heat detector, short circuit isolator (*)
ML-1140.SCI/M	Multisensor detector, short circuit isolator (*)

### CONVENTIONAL SYSTEM SPMS POWER SUPPLIES

Product code	Description
ML-0515/M	SMPS power supply, 5A (*)
ML-05110/M	SMPS power supply, 10A (*)

### INTELLIGENT ADDRESSABLE SYSTEM SMOKE DAMPER CONTROL PANEL

Product code	Description
ML-1353/M	16 way I/O Panel (*)
ML-1354/M	Smoke damper control panel, 16 way I/O module (*)
ML-1355/M	Smoke damper control panel with toggle switch, 16 way I/O module (*)
ML-1356/M	Smoke damper module, 1 output, 24V DC
ML-1357/M	Smoke damper module, 1 output, 24V AC
ML-1358/M	Smoke damper module, 1 output, 220V AC
ML-1356.SCI/M	Smoke damper module, 1 output, 24V DC, short circuit isolator
ML-1357.SCI/M	Smoke damper module, 1 output, 24V AC, short circuit isolator
ML-1358.SCI/M	Smoke damper module, 1 output, 220V AC, short circuit isolator

### INTELLIGENT ADDRESSABLE SYSTEM GCU (GATEWAY CONTROL UNIT) PANEL

Product code	Description
ML-1207.C/M	GCU panel, TCP/IP module included
ML-1207.G/M	GCU panel, GPRS module included
ML-1207.K/M	GCU panel, RS232/RS485 module included
ML-1207.CGK/M	GCU panel, TCP/IP, GPRS, RS232/RS485 modules included
ML-1207.B/M	GCU panel, BACnet module included
ML-1207.MX/M	GCU panel, Modbus module included
ML-1207.NTP/M	NTP server communication module

### INTELLIGENT ADDRESSABLE SYSTEM BEAM TYPE SMOKE DETECTORS

Product code	Description
ML-1170/M	Beam type smoke detector (included receiver-transmitter) (*)
ML-1170.SCI/M	Beam type smoke detector, with short circuit isolator (included receiver-transmitter) (*)
ML-1173/M	Reflective beam type smoke detector (*)
ML-1173.SCI/M	Reflective beam type smoke detector, with short circuit isolator (*)

### CONVENTIONAL SYSTEM BEAM TYPE SMOKE DETECTORS

Product code	Description
ML-2170/M	Beam type smoke detector (receiver and transmitter is included) (*)
ML-2173/M	Reflector beam type smoke detector (*)

### CONVENTIONAL SYSTEM ACCESSORIES

Product code	Description
ML-2410/M	Conventional sounder (*)
ML-2420/M	Conventional beacon (*)
ML-2430/M	Conventional sounder & beacon (*)
ML-2440/M	Conventional sounder, weatherproof (IP33) (*)
ML-2450/M	Conventional beacon, weatherproof (IP33) (*)
ML-2460/M	Conventional sounder & beacon, weatherproof (IP33) (*)
ML-2470/M	Conventional sounder, weatherproof (IP65) (*)
ML-2480/M	Conventional beacon, weatherproof (IP65) (*)
ML-2490/M	Conventional sounder & beacon, weatherproof (IP65) (*)
ML-2710/M	Conventional manual call point, resettable (*)
ML-0710/M	Protection cover for manual call point

### INTELLIGENT ADDRESSABLE SYSTEM ACCESSORIES

Product code	Description
MG-3510/M	Mounting base for detectors, white
MG-3520/M	Mounting base c/w short circuit isolator
MG-3530/M	Mounting base c/w buzzer
MG-3600/M	Accessories for fire detectors recessed mounting base, white (excl. detector and base) (*)
MG-3700/M	Weatherproof back box for fire detectors (*)
ML-1101/M	Loop powered base sounder (*)
ML-1102/M	Loop powered base sounder & beacon (*)
ML-0140/M	Mounting base (*)
ML-0141/M	Mounting base c/w Buzzer
ML-0144/M	Mounting base (B class) (*)
ML-0121/M	Weatherproof surface mounting back box (*)
ML-0120/M	Surface mounting back box
ML-0150/M	Recessed mounting base (*)

### ANNOUNCE / ALARM MATRIX PANEL AND 7" TFT MIMIC PANEL

Product code	Description
ML-5020/M	Announce / Alarm matrix panel, 19", 3U rack structure (*)
ML-1280/M	7" TFT mimic panel (*)

### INTELLIGENT ADDRESSABLE SYSTEM ACCESSORIES

Product code	Description
ML-1410/M	Intelligent addressable system sounder (*)
ML-1410.SCI/M	Intelligent addressable system sounder with short circuit isolator (*)
ML-1420/M	Intelligent addressable system beacon (*)
ML-1420.SCI/M	Intelligent addressable system beacon with short circuit isolator (*)
ML-1430/M	Intelligent addressable system sounder & beacon (*)
ML-1430.SCI/M	Intelligent addressable system sounder & beacon with short circuit isolator (*)
ML-1440/M	Intelligent addressable system sounder, weatherproof (IP33) (*)
ML-1440.SCI/M	Intelligent addressable system sounder, weatherproof (IP33), short circuit isolator (*)
ML-1450/M	Intelligent addressable system beacon, weatherproof (IP33) (*)
ML-1450.SCI/M	Intelligent addressable system beacon, weatherproof (IP33), short circuit isolator (*)
ML-1460/M	Intelligent addressable system sounder & beacon, weatherproof (IP33) (*)
ML-1460.SCI/M	Intelligent addressable system sounder & beacon, weatherproof (IP33), short circuit isolator (*)
ML-1470/M	Intelligent addressable system sounder, weatherproof (IP65) (*)
ML-1470.SCI/M	Intelligent addressable system sounder, weatherproof (IP65), short circuit isolator (*)
ML-1480/M	Intelligent addressable system beacon, weatherproof (IP65) (*)
ML-1480.SCI/M	Intelligent addressable system beacon, weatherproof (IP65), short circuit isolator (*)
ML-1490/M	Intelligent addressable system sounder & beacon, weatherproof (IP65) (*)
ML-1490.SCI/M	Intelligent addressable system sounder & beacon, weatherproof (IP65), short circuit isolator (*)
ML-1710/M	Manual call point, resettable (*)
ML-1730/M	Manual call point weatherproof (IP67), resettable (*)
ML-1710.SCI/M	Manual call point, resettable, short circuit isolator (*)
ML-1730.SCI/M	Manual call point weatherproof (IP67), resettable, short circuit isolator (*)

### CONVENTIONAL SYSTEM FIRE ALARM CONTROL PANEL

Product code	Description
ML-22102/M	Conventional fire alarm panel, 2 zone (*)
ML-22104/M	Conventional fire alarm panel, 4 zone (*)
ML-22108/M	Conventional fire alarm panel, 8 zone (*)
ML-22116/M	Conventional fire alarm panel, 16 zone (*)
MGRP-64/M	Conventional repeater panel (*)
ML-0314/M	Sounder expansion panel
ML-2222/M	Conventional system fire alarm control panel, 2 zone
ML-2224/M	Conventional system fire alarm control panel, 4 zone
ML-2228/M	Conventional system fire alarm control panel, 8 zone

### FIRE EXTINGUISHING CONTROL PANEL

Product code	Description
ML-322/M	Conventional fire extinguishing control panel 4 detection zones, 1 extinguishing area, manual release inc. (*)
ML-3313/M	Extinguishing status indicator unit, with extinguishing status switch and releasing button (*)
ML-3314/M	Extinguishing output expansion panel
MG-400/M	Gas alarm control panel, 4 channel
ML-2710.MR/M	Extinguishant manual release button (*)
ML-2710.ES/M	Extinguishant emergency stop button (*)
MG-5400/M	Electronic alarm bell (*)

[www.mavili.com.tr/en](http://www.mavili.com.tr/en)

Follow us...



.../mavilielektronikglobal